



Wake Robin Inn Redevelopment

104 & 106 Sharon Road, Salisbury, Connecticut

Drainage Report

Prepared for:
Aradev LLC

352 Atlantic Avenue, Unit 2
Brooklyn, NY 11217

Prepared by:

SLR International Corporation

99 Realty Drive, Cheshire, Connecticut, 06410

SLR Project No.: 141.22100.00001

July 19, 2024

Revised August 1, 2024

Drainage Report

Wake Robin Inn Redevelopment
104 & 106 Sharon Road
Salisbury, Connecticut
July 19, 2024
Revised August 1, 2024
SLR #141.22100.00001

This Drainage Report has been prepared in support of the proposed Wake Robin Inn redevelopment located on 104 & 106 Sharon Road in the town of Salisbury, Connecticut. The development proposes to redevelop the existing Wake Robin Inn site with a building addition to the existing hotel, and event barn, a gym and spa, a pool, and associated parking, drives, and walking trails.



Figure 1 – 104 & 106 Sharon Road



Table 1 – Stormwater Data

Parcel Size Total	13.79 acres
Existing Impervious Area (Watershed Area)	1.0 acres
Proposed Impervious Area (Watershed Area)	2.8 acres
Soil Type (Hydrologic Soil Group)	"B", "C", and "D"
Existing Land Use	Woods, open space, gravel, building, and driveway
Proposed Land Use	Woods, open space, gravel, building, and driveway
Design Storm for Stormwater Management	No increases in peak rates of runoff for the 2-, 10-, 25-, 50-, and 100-year storms Connecticut Department of Energy & Environmental Protection (CTDEEP) water quality volume (WQV) and water quality flow (WQF) treatment
Water Quality Measures	Catch basins with 2-foot sumps, hydrodynamic separator, retention storage for WQV
Design Storm for Storm Drainage	10-year storm
Federal Emergency Management Agency (FEMA) Special Flood Hazard Areas	Area of Minimal Flood Hazard (Zone X)
Connecticut Department of Energy & Environmental Protection Aquifer Protection Areas	Lakeville (Pettee Street) – Level A

Stormwater Management Approach

The proposed stormwater management system for the project focuses on providing water quality management while attenuating proposed peak-flows. Water quality treatment in accordance with the CTDEEP requirements for water quality volume (WQV) and water quality flow (WQF) is provided. The proposed stormwater treatment train consists of catch basins with 2-foot sumps, a hydrodynamic separator, and retention storage for the WQV.

The computer program entitled *Hydraflow Storm Sewers Extension for AutoCAD® Civil 3D® 2023* by Autodesk, Inc. was used for designing the proposed storm drainage collection system. Storm drainage computations performed include pipe capacity and hydraulic grade line calculations. The contributing watershed to each individual catch basin inlet was delineated to determine the drainage area and land coverage. These values were used to determine the stormwater runoff to each inlet using the Rational Method. The rainfall intensities for the site were obtained from the National Oceanic and Atmospheric Administration (NOAA) Atlas 14, Volume 10, Precipitation Frequency Data Server (PFDS). The proposed storm drainage system



is designed to provide adequate capacity to convey the 10-year storm event.

Water Quality Management

Water quality measures or Best Management Practices (BMPs) have been incorporated into the design to maintain water quality to provide protection of the areas downgradient of the proposed development. The proposed stormwater management system will include catch basins with 2-foot sumps, a hydrodynamic separator, and retention storage for the WQV.

Each of the proposed stormwater basins and the underground chamber system will provide retention volume along its bottom, thus creating a water quality feature within it. This serves several purposes, including stormwater renovation and providing WQV. The *CTDEEP 2024 Stormwater Quality Manual* (Chapter 7) recommends methods for sizing stormwater treatment measures with WQV computations. The WQV addresses the initial stormwater runoff, also commonly referred to as the "first-flush" runoff. The WQV provides adequate volume to store the runoff associated with the first 1.3 inches of rainfall, which tends to contain the highest concentration of potential pollutants.

A hydrodynamic separator will be installed in the proposed storm drainage system prior to discharging stormwater to Detention Basin 210. This unit will further remove suspended solids before discharging downgradient, which will in turn remove other pollutants that tend to attach to the suspended solids and effectively remove other debris and floatables that may be present in stormwater runoff. The hydrodynamic separator has been designed to meet criteria recommended by the *CTDEEP 2024 Stormwater Quality Manual*. The device was designed based on the determined WQF, which is the peak-flow rate associated with the Water Quality Volume (WQV) and sized based on the manufacturer's specifications.

Hydrologic Analysis

A hydrologic analysis was conducted to analyze the pre-development and post-development peak-flow rates from the site. Three analysis points that receive runoff from the site were selected. Analysis Point A represents Wells Hill Road and the properties to the north of the site. Analysis Point B represents the existing storm drainage in Sharon Road adjacent to the site. Analysis Point C represents the properties southwest of the site and Sharon Road. The total watershed area delineated is approximately 25.2 acres under both existing and proposed conditions.

The method of predicting the surface water runoff rates utilized in this analysis was a computer program titled *HydroCAD 10.20-4a* by HydroCAD Software Solutions LLC. The *HydroCAD* program is a computer model that utilizes the methodologies set forth in the *Technical Release No. 55* (TR-55) manual and *Technical Release No. 20* (TR-20) computer model, originally developed by the United States Department of Agriculture – Natural Resources Conservation Service (USDA-NRCS). The *HydroCAD* computer modeling program is primarily used for conducting hydrology studies such as this one.

The *HydroCAD* computer program forecasts the rate of surface water runoff based upon several factors. The input data includes information on land use, hydrologic soil type, vegetation, contributing watershed area, time of concentration, rainfall data, storage volumes, and the



hydraulic capacity of structures. The computer model predicts the amount of runoff as a function of time, with the ability to include the attenuation effect due to dams, lakes, large wetlands, floodplains, and stormwater management basins. The input data for rainfalls with statistical recurrence frequencies of 2, 10, 25, 50, and 100 years was obtained from the NOAA Atlas 14, Volume 10 database. The corresponding rainfall totals are listed below.

Storm Frequency	Rainfall (inches)
2-year	3.08
10-year	5.11
25-year	6.37
50-year	7.28
100-year	8.32

Land use for the site under existing and proposed conditions was determined from field survey and aerial photogrammetry. Land use types used in the analysis included woods, grassed or open space, gravel, building, and impervious (paved) cover. Soil types in the watershed were determined from the CTDEEP Geographic Information System (GIS) database of the USDA-NRCS soil survey for Litchfield County, Connecticut. For the analysis, the site was determined to contain hydrologic soil types "B", "C", and "D" as classified by USDA-NRCS. Composite runoff Curve Numbers (CN) for each subwatershed were calculated based on the different land use and soil types. The time of concentration (Tc) was estimated for each subwatershed using the TR-55 methodology and was computed by summing all travel times through the watershed as sheet flow, shallow concentrated flow, and channel flow.

The existing conditions were modeled with the *HydroCAD* program to determine the peak-flow rates for the various storm events at each analysis point. A revised model was developed incorporating the proposed site conditions, stormwater detention basins, and underground chamber system. The flows obtained with the revised model were then compared to the results of the existing conditions model. Peak-flow rates from the project site were controlled by the storage volume provided within the detention basins and underground chambers and their respective outlet control structures.

The following peak rates of runoff were obtained from the *HydroCAD* hydrology results:

Analysis Point A – Wells Hill Road					
	Peak Runoff Rate (cubic feet per second)				
Storm Frequency (years)	2	10	25	50	100
Existing Conditions	7.5	21.5	31.3	38.6	47.1
Proposed Conditions	7.3	21.2	30.5	37.4	45.4



Underground Chamber System 120*					
	Water Surface Elevation (feet)				
Storm Frequency (years)	2	10	25	50	100
Proposed Conditions	816.6	818.1	818.4	818.5	818.6

*Inside Top of Chamber Elevation = 819.0

Plunge Pool 120**					
	Water Surface Elevation (feet)				
Storm Frequency (years)	2	10	25	50	100
Proposed Conditions	815.0	815.1	815.1	815.2	815.2

**Top of Berm Elevation = 816.0

Analysis Point B – Sharon Road Storm Drainage					
	Peak Runoff Rate (cubic feet per second)				
Storm Frequency (years)	2	10	25	50	100
Existing Conditions	5.8	13.1	17.8	21.2	25.2
Proposed Conditions	3.6	10.1	15.1	18.2	21.6

Detention Basin 210***					
	Water Surface Elevation (feet)				
Storm Frequency (years)	2	10	25	50	100
Proposed Conditions	815.4	816.0	816.4	816.7	816.9

***Top of Berm Elevation = 818.0

Detention Basin 220****					
	Water Surface Elevation (feet)				
Storm Frequency (years)	2	10	25	50	100
Proposed Conditions	801.9	802.7	802.8	802.9	802.9

****Top of Berm Elevation = 804.0



Analysis Point C – Sharon Road and Southern Properties					
	Peak Runoff Rate (cubic feet per second)				
Storm Frequency (years)	2	10	25	50	100
Existing Conditions	1.6	4.0	5.6	6.8	8.1
Proposed Conditions	1.5	3.4	4.7	5.7	6.7

Conclusion

The results of the hydrologic analysis demonstrate that there will be no increases in peak-flow rates from the proposed redevelopment. This was achieved for the storm events modeled through a planned stormwater management system with detention provided in the stormwater detention basins and underground storage chambers. The proposed development will also introduce a new stormwater treatment train consisting of catch basins with 2-foot sumps, a hydrodynamic separator, and retention storage for the WQV.

All supporting documentation and stormwater-related computations are attached to this report along with the *HydroCAD* model results for stormwater management and *Hydraflow Storm Sewers* model results for the proposed storm drainage system. Illustrative Watershed Maps for both existing and proposed conditions are also attached to this report.

Appendices

Appendix A	United States Geological Survey Location Map
Appendix B	Federal Emergency Management Agency Flood Insurance Rate Map
Appendix C	Natural Resources Conservation Service Hydrologic Soil Group Map
Appendix D	Storm Drainage Computations
Appendix E	Water Quality Computations
Appendix F	Hydrologic Analysis – Input Computations
Appendix G	Hydrologic Analysis – Computer Model Results
Appendix H	Watershed Maps



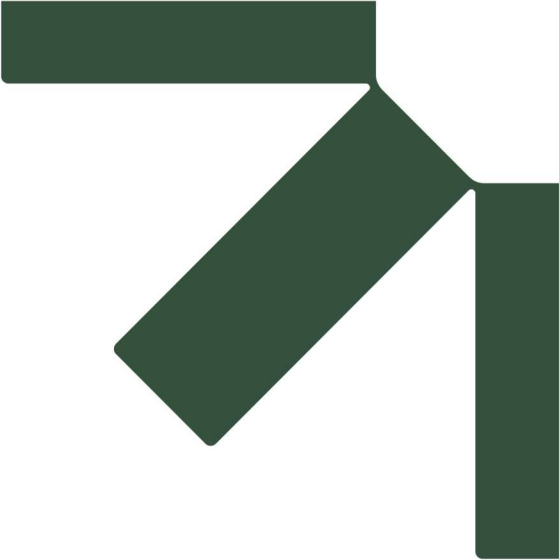

Appendix A United States Geological Survey Location Map

Wake Robin Inn Redevelopment

104 & 106 Sharon Road, Salisbury, Connecticut

Drainage Report

Prepared for:
Aradev LLC
352 Atlantic Avenue, Unit 2
Brooklyn, NY 11217

SLR Project No.: 141.22100.00001

July 19, 2024

Revised August 1, 2024



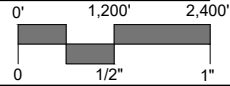
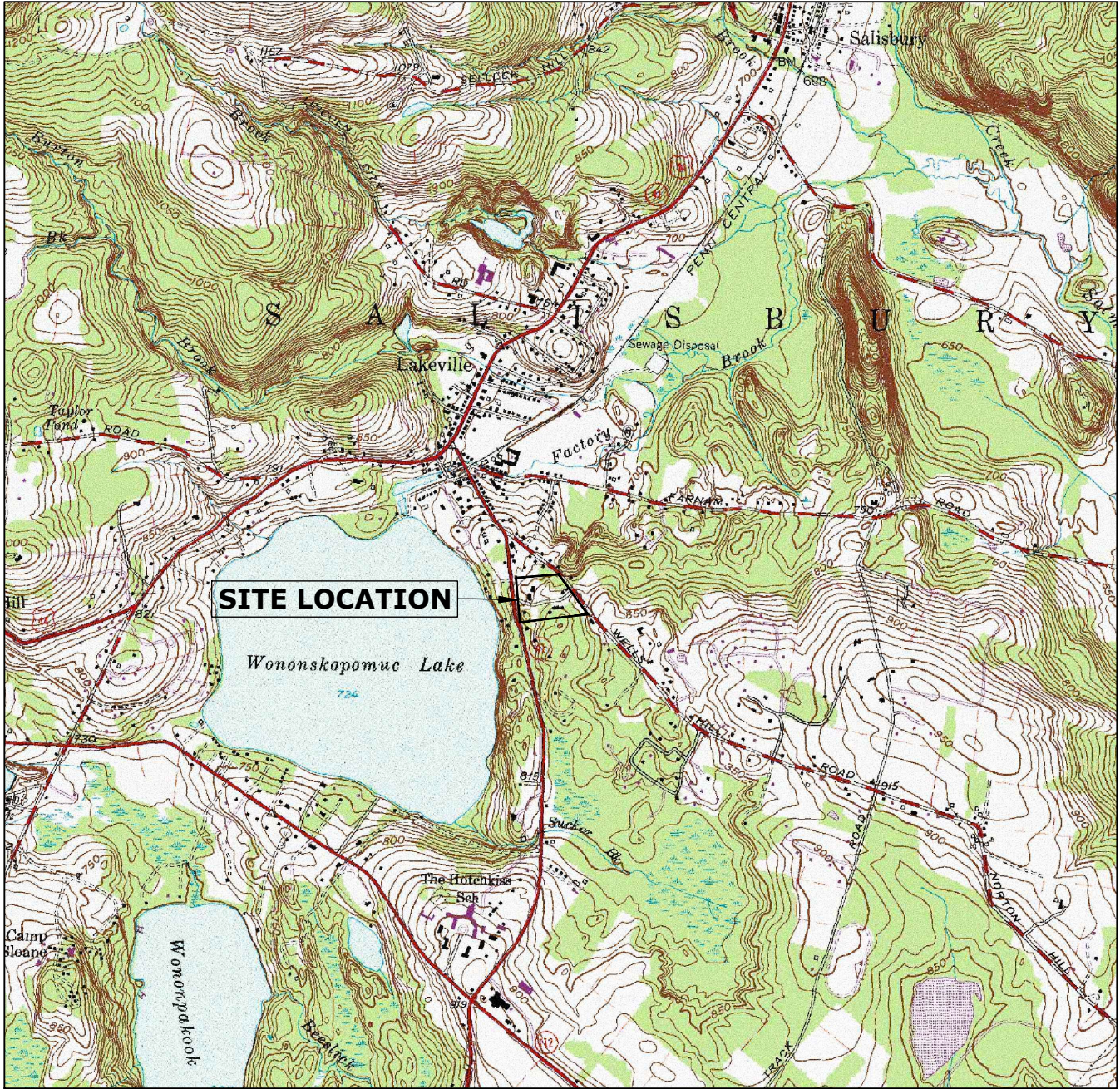
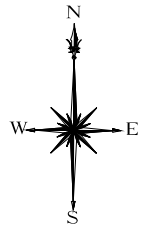

99 REALTY DRIVE
CHESHIRE, CT 06410
203.271.1773
SLRCONSULTING.COM

USGS QUADRANGLE MAP, QUAD NO. 16

**WAKE ROBIN
EVENT VENUE**

**104 AND 106 SHARON ROAD
SALISBURY, CONNECTICUT**

PROJECT PHASE:

REV: ---

DATE JULY 19, 2024		
SCALE 1"=2,400'		
PROJ. NO. 22100.00001		
DESIGNED ---	DRAWN MCB	CHECKED ---
DRAWING NAME: LOC		



Appendix B

FEMA Flood Insurance Rate Map

Wake Robin Inn Redevelopment

104 & 106 Sharon Road, Salisbury, Connecticut

Drainage Report

Prepared for:
Aradev LLC
352 Atlantic Avenue, Unit 2
Brooklyn, NY 11217

SLR Project No.: 141.22100.00001

July 19, 2024

Revised August 1, 2024



Agent or call the National Flood Insurance Program at (800) 538-6620.



APPROXIMATE SCALE

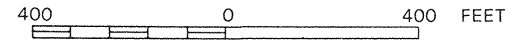

ZONE X

WELLS

HILL

ROAD

NATIONAL FLOOD INSURANCE PROGRAM

FIRM
FLOOD INSURANCE RATE MAP

TOWN OF
SALISBURY,
CONNECTICUT
LITCHFIELD COUNTY

PANEL 18 OF 30
(SEE MAP INDEX FOR PANELS NOT PRINTED)



PANEL LOCATION

COMMUNITY-PANEL NUMBER
090052 0018 B

EFFECTIVE DATE:
JANUARY 5, 1989



Federal Emergency Management Agency

This is an official FIRMette showing a portion of the above-referenced flood map created from the MSC FIRMette Web tool. This map does not reflect changes or amendments which may have been made subsequent to the date on the title block. For additional information about how to make sure the map is current, please see the Flood Hazard Mapping Updates Overview Fact Sheet available on the FEMA Flood Map Service Center home page at <https://msc.fema.gov>.



Appendix C

Natural Resources Conservation Service Hydrologic Soil Group Map

Wake Robin Inn Redevelopment

104 & 106 Sharon Road, Salisbury, Connecticut

Drainage Report

Prepared for:
Aradev LLC
352 Atlantic Avenue, Unit 2
Brooklyn, NY 11217

SLR Project No.: 141.22100.00001

July 19, 2024

Revised August 1, 2024



Hydrologic Soil Group—State of Connecticut, Western Part

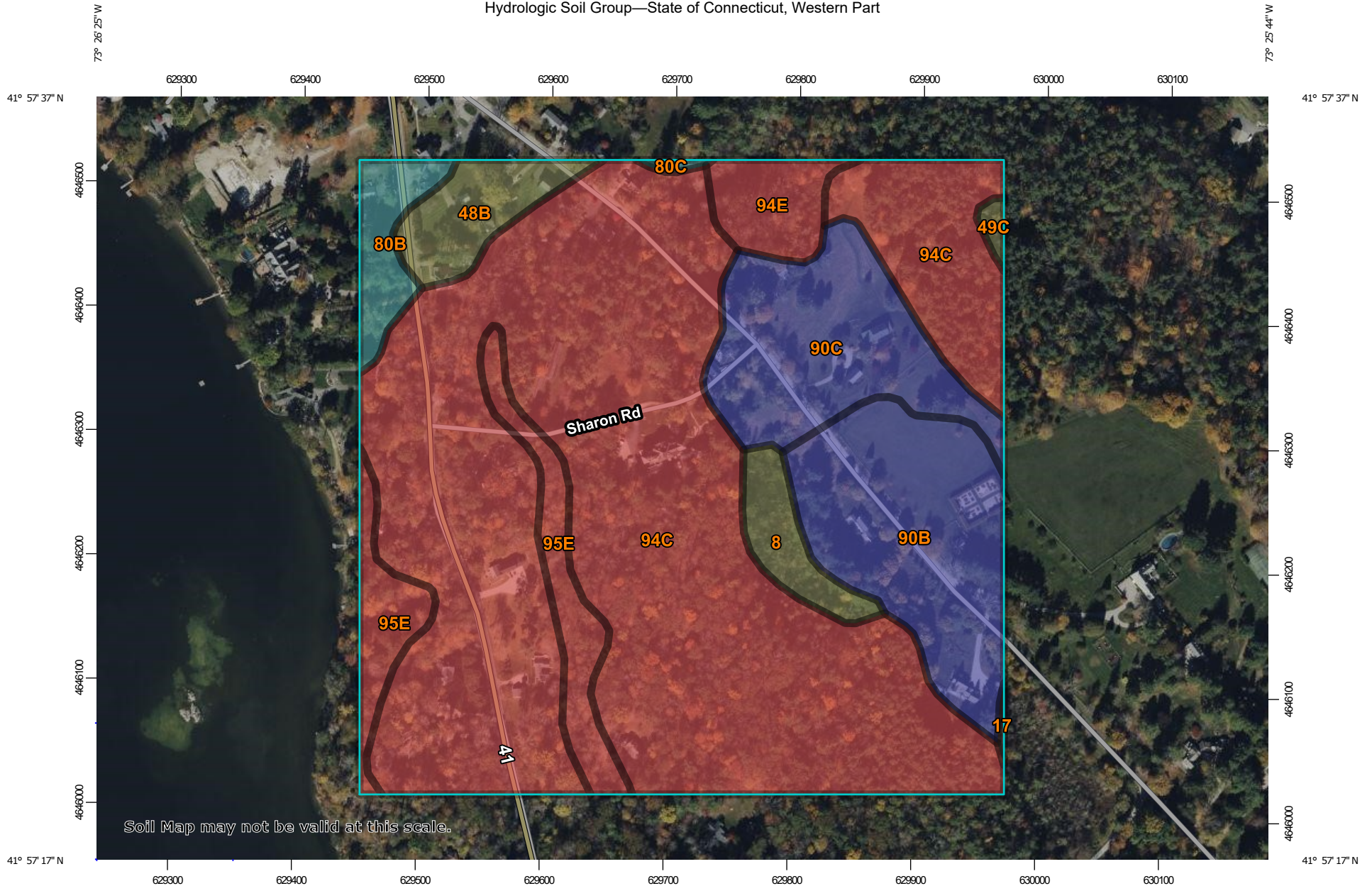

Soil Map may not be valid at this scale.

Map Scale: 1:4,320 if printed on A landscape (11" x 8.5") sheet.

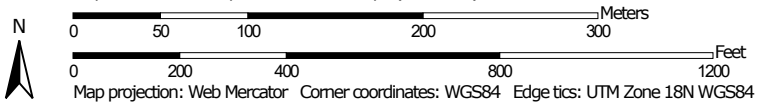

MAP LEGEND

Area of Interest (AOI)









 Area of Interest (AOI)

Soils

Soil Rating Polygons





 A
 A/D
 B
 B/D
 C
 C/D
 D
 Not rated or not available

Soil Rating Lines

 A
 A/D
 B
 B/D
 C
 C/D
 D
 Not rated or not available

Soil Rating Points





 A
 A/D
 B
 B/D

 C
 C/D
 D
 Not rated or not available

Water Features

 Streams and Canals

Transportation

 Rails
 Interstate Highways
 US Routes
 Major Roads
 Local Roads

Background

 Aerial Photography

MAP INFORMATION

The soil surveys that comprise your AOI were mapped at 1:12,000.

Warning: Soil Map may not be valid at this scale.

Enlargement of maps beyond the scale of mapping can cause misunderstanding of the detail of mapping and accuracy of soil line placement. The maps do not show the small areas of contrasting soils that could have been shown at a more detailed scale.

Please rely on the bar scale on each map sheet for map measurements.

Source of Map: Natural Resources Conservation Service
 Web Soil Survey URL:
 Coordinate System: Web Mercator (EPSG:3857)

Maps from the Web Soil Survey are based on the Web Mercator projection, which preserves direction and shape but distorts distance and area. A projection that preserves area, such as the Albers equal-area conic projection, should be used if more accurate calculations of distance or area are required.

This product is generated from the USDA-NRCS certified data as of the version date(s) listed below.

Soil Survey Area: State of Connecticut, Western Part
 Survey Area Data: Version 1, Sep 15, 2023

Soil map units are labeled (as space allows) for map scales 1:50,000 or larger.

Date(s) aerial images were photographed: Oct 21, 2022—Oct 27, 2022

The orthophoto or other base map on which the soil lines were compiled and digitized probably differs from the background imagery displayed on these maps. As a result, some minor shifting of map unit boundaries may be evident.

Hydrologic Soil Group

Map unit symbol	Map unit name	Rating	Acres in AOI	Percent of AOI
8	Mudgepond and Alden soils, extremely stony	C/D	1.5	2.3%
17	Timakwa and Natchaug soils, 0 to 2 percent slopes	B/D	0.1	0.1%
48B	Georgia and Amenia silt loams, 2 to 8 percent slopes	C/D	2.1	3.2%
49C	Georgia and Amenia silt loams, 8 to 15 percent slopes, very stony	C/D	0.2	0.3%
80B	Bernardston silt loam, 3 to 8 percent slopes	C	1.6	2.4%
80C	Bernardston silt loam, 8 to 15 percent slopes	C	0.1	0.2%
90B	Stockbridge loam, 3 to 8 percent slopes	B	7.4	11.3%
90C	Stockbridge loam, 8 to 15 percent slopes	B	6.2	9.4%
94C	Farmington-Nellis complex, 3 to 15 percent slopes, very rocky	D	41.0	62.3%
94E	Farmington-Nellis complex, 15 to 35 percent slopes, very rocky	D	1.7	2.6%
95E	Farmington-Rock outcrop complex, 15 to 45 percent slopes	D	3.9	6.0%
Totals for Area of Interest			65.9	100.0%

Description

Hydrologic soil groups are based on estimates of runoff potential. Soils are assigned to one of four groups according to the rate of water infiltration when the soils are not protected by vegetation, are thoroughly wet, and receive precipitation from long-duration storms.

The soils in the United States are assigned to four groups (A, B, C, and D) and three dual classes (A/D, B/D, and C/D). The groups are defined as follows:

Group A. Soils having a high infiltration rate (low runoff potential) when thoroughly wet. These consist mainly of deep, well drained to excessively drained sands or gravelly sands. These soils have a high rate of water transmission.

Group B. Soils having a moderate infiltration rate when thoroughly wet. These consist chiefly of moderately deep or deep, moderately well drained or well drained soils that have moderately fine texture to moderately coarse texture. These soils have a moderate rate of water transmission.

Group C. Soils having a slow infiltration rate when thoroughly wet. These consist chiefly of soils having a layer that impedes the downward movement of water or soils of moderately fine texture or fine texture. These soils have a slow rate of water transmission.

Group D. Soils having a very slow infiltration rate (high runoff potential) when thoroughly wet. These consist chiefly of clays that have a high shrink-swell potential, soils that have a high water table, soils that have a claypan or clay layer at or near the surface, and soils that are shallow over nearly impervious material. These soils have a very slow rate of water transmission.

If a soil is assigned to a dual hydrologic group (A/D, B/D, or C/D), the first letter is for drained areas and the second is for undrained areas. Only the soils that in their natural condition are in group D are assigned to dual classes.

Rating Options

Aggregation Method: Dominant Condition

Component Percent Cutoff: None Specified

Tie-break Rule: Higher



Appendix D

Storm Drainage Computations

Wake Robin Inn Redevelopment

104 & 106 Sharon Road, Salisbury, Connecticut

Drainage Report

Prepared for:
Aradev LLC
352 Atlantic Avenue, Unit 2
Brooklyn, NY 11217

SLR Project No.: 141.22100.00001

July 19, 2024

Revised August 1, 2024



Rational Method Individual Basin Calculations

Project: Wake Robin Inn
 Location: Salisbury, CT

By: MCB
 Checked: _____

Date: 7/18/24
 Date: _____

Basin Name	Impervious Area C=0.9 (sf)	Grassed Area C=0.3 (sf)	Wooded Area C=0.2 (sf)	Total Area (sf)	Total Area (ac)	Weighted C	Tc (min)
System 120							
CLCB 2	11925	911	0	12836	0.29	0.86	5.0
CLCB 4	1945	518	0	2463	0.06	0.77	5.0
CLCB 5	6103	3999	0	10102	0.23	0.66	5.0
System 200							
YD 6	0	45	8700	8745	0.20	0.20	5.0
YD 7	2911	2585	16621	22117	0.51	0.30	5.0
YD 8	7326	7267	30735	45328	1.04	0.33	5.0
YD 9	3313	4068	189	7570	0.17	0.56	5.0
CLCB 10	11883	21081	0	32964	0.76	0.52	5.0
System 210							
YD 14	454	957	0	1411	0.03	0.49	5.0
CLCB 15	12861	8125	1149	22135	0.51	0.64	5.0
CLCB 16	3365	4367	0	7732	0.18	0.56	5.0
YD 17	2516	7615	0	10131	0.23	0.45	5.0
YD 18	338	0	0	338	0.01	0.90	5.0
YD 19	346	0	0	346	0.01	0.90	5.0
YD 20	331	0	0	331	0.01	0.90	5.0
System 220							
YD 24	2112	4834	0	6946	0.16	0.48	5.0
YD 25	4236	4091	0	8327	0.19	0.61	5.0
YD 26	213	887	0	1100	0.03	0.42	5.0
WS 11							
Culvert	29563	107963	471865	609391	13.99	0.25	38.8

Rational Method Roof Drain System Calculations

Project: Wake Robin Inn
 Location: Salisbury, CT

By: MCB
 Checked: _____

Date: 7/18/24
 Date: _____

Total Roof Runoff to Proposed Storm Drainage System (In Hydraflow Model)

	ROOF TO CLCB 4	ROOF TO CLCB 5	ROOF TO YD 14	ROOF TO CLCB 16	CULVERT		
C	0.90	0.90	0.90	0.90	0.25		
I	6.98	6.98	6.98	6.98	3.23		
A	0.05	0.05	0.10	0.26	13.99		
Q	0.31	0.31	0.63	1.63	11.30		



POINT PRECIPITATION FREQUENCY ESTIMATES

Sanja Perica, Sandra Pavlovic, Michael St. Laurent, Carl Trypaluk, Dale Unruh, Orlan Wilhite

NOAA, National Weather Service, Silver Spring, Maryland

[PF_tabular](#) | [PF_graphical](#) | [Maps & aerials](#)

PF tabular

PDS-based point precipitation frequency estimates with 90% confidence intervals (in inches/hour)¹										
Duration	Average recurrence interval (years)									
	1	2	5	10	25	50	100	200	500	1000
5-min	4.01 (3.06-5.24)	4.75 (3.64-6.22)	5.96 (4.55-7.84)	6.97 (5.29-9.22)	8.36 (6.16-11.5)	9.42 (6.80-13.2)	10.5 (7.37-15.3)	11.7 (7.82-17.4)	13.3 (8.60-20.6)	14.6 (9.23-23.0)
10-min	2.84 (2.17-3.71)	3.37 (2.57-4.40)	4.23 (3.23-5.56)	4.94 (3.74-6.53)	5.93 (4.36-8.15)	6.67 (4.81-9.38)	7.44 (5.22-10.8)	8.27 (5.54-12.4)	9.41 (6.09-14.6)	10.3 (6.53-16.3)
15-min	2.22 (1.70-2.91)	2.64 (2.02-3.46)	3.32 (2.52-4.36)	3.88 (2.94-5.12)	4.65 (3.42-6.40)	5.23 (3.77-7.35)	5.84 (4.09-8.48)	6.48 (4.35-9.69)	7.38 (4.78-11.4)	8.10 (5.12-12.8)
30-min	1.53 (1.17-2.00)	1.81 (1.39-2.37)	2.28 (1.74-3.00)	2.67 (2.02-3.53)	3.20 (2.36-4.41)	3.61 (2.60-5.07)	4.03 (2.83-5.87)	4.49 (3.01-6.71)	5.15 (3.33-7.96)	5.68 (3.59-8.97)
60-min	0.971 (0.743-1.27)	1.15 (0.882-1.51)	1.45 (1.11-1.91)	1.70 (1.29-2.25)	2.04 (1.50-2.82)	2.30 (1.66-3.24)	2.57 (1.81-3.75)	2.87 (1.92-4.29)	3.30 (2.13-5.11)	3.65 (2.31-5.77)
2-hr	0.638 (0.490-0.831)	0.740 (0.568-0.965)	0.907 (0.694-1.19)	1.05 (0.796-1.38)	1.24 (0.913-1.69)	1.38 (1.00-1.93)	1.53 (1.08-2.21)	1.69 (1.14-2.52)	1.91 (1.24-2.95)	2.09 (1.32-3.29)
3-hr	0.488 (0.376-0.634)	0.566 (0.435-0.735)	0.692 (0.531-0.902)	0.797 (0.608-1.04)	0.941 (0.697-1.29)	1.05 (0.763-1.46)	1.16 (0.821-1.68)	1.29 (0.867-1.91)	1.46 (0.948-2.24)	1.60 (1.02-2.51)
6-hr	0.299 (0.231-0.387)	0.354 (0.274-0.458)	0.444 (0.342-0.577)	0.519 (0.398-0.678)	0.622 (0.464-0.851)	0.698 (0.512-0.979)	0.781 (0.559-1.14)	0.879 (0.594-1.30)	1.03 (0.669-1.58)	1.15 (0.734-1.80)
12-hr	0.174 (0.135-0.224)	0.216 (0.167-0.278)	0.284 (0.220-0.367)	0.340 (0.262-0.442)	0.418 (0.315-0.575)	0.475 (0.352-0.670)	0.538 (0.392-0.797)	0.620 (0.419-0.919)	0.753 (0.491-1.16)	0.870 (0.557-1.36)
24-hr	0.100 (0.078-0.128)	0.128 (0.100-0.164)	0.174 (0.135-0.224)	0.212 (0.164-0.275)	0.265 (0.201-0.364)	0.303 (0.227-0.429)	0.346 (0.255-0.516)	0.404 (0.274-0.597)	0.501 (0.328-0.766)	0.587 (0.377-0.916)
2-day	0.057 (0.044-0.072)	0.073 (0.057-0.093)	0.100 (0.078-0.128)	0.123 (0.095-0.158)	0.153 (0.117-0.210)	0.176 (0.132-0.248)	0.201 (0.149-0.299)	0.235 (0.160-0.346)	0.292 (0.191-0.445)	0.343 (0.221-0.533)
3-day	0.041 (0.032-0.052)	0.053 (0.042-0.067)	0.072 (0.057-0.092)	0.088 (0.069-0.113)	0.110 (0.084-0.151)	0.126 (0.095-0.178)	0.144 (0.107-0.214)	0.169 (0.115-0.248)	0.210 (0.138-0.319)	0.246 (0.159-0.382)
4-day	0.033 (0.026-0.042)	0.042 (0.033-0.054)	0.058 (0.045-0.074)	0.070 (0.055-0.090)	0.088 (0.067-0.120)	0.100 (0.076-0.141)	0.115 (0.085-0.170)	0.134 (0.091-0.197)	0.166 (0.109-0.252)	0.195 (0.126-0.302)
7-day	0.022 (0.018-0.028)	0.028 (0.022-0.036)	0.038 (0.030-0.048)	0.046 (0.036-0.059)	0.057 (0.044-0.078)	0.065 (0.049-0.091)	0.074 (0.055-0.109)	0.086 (0.059-0.126)	0.106 (0.070-0.161)	0.123 (0.080-0.191)
10-day	0.018 (0.014-0.023)	0.023 (0.018-0.029)	0.030 (0.023-0.038)	0.036 (0.028-0.045)	0.044 (0.033-0.059)	0.050 (0.037-0.069)	0.056 (0.042-0.082)	0.065 (0.044-0.095)	0.079 (0.052-0.120)	0.091 (0.059-0.141)
20-day	0.013 (0.010-0.016)	0.015 (0.012-0.019)	0.019 (0.015-0.024)	0.022 (0.017-0.028)	0.026 (0.020-0.035)	0.030 (0.022-0.041)	0.033 (0.024-0.047)	0.037 (0.026-0.054)	0.044 (0.029-0.066)	0.049 (0.032-0.076)
30-day	0.011 (0.009-0.014)	0.012 (0.010-0.016)	0.015 (0.012-0.019)	0.017 (0.013-0.022)	0.020 (0.015-0.027)	0.022 (0.017-0.030)	0.024 (0.018-0.035)	0.027 (0.019-0.039)	0.031 (0.021-0.047)	0.034 (0.022-0.053)
45-day	0.009 (0.007-0.011)	0.010 (0.008-0.013)	0.012 (0.009-0.015)	0.013 (0.011-0.017)	0.015 (0.012-0.020)	0.017 (0.013-0.023)	0.019 (0.013-0.026)	0.020 (0.014-0.029)	0.022 (0.015-0.034)	0.024 (0.016-0.037)
60-day	0.008 (0.006-0.010)	0.009 (0.007-0.011)	0.010 (0.008-0.013)	0.011 (0.009-0.014)	0.013 (0.010-0.017)	0.014 (0.010-0.019)	0.015 (0.011-0.021)	0.016 (0.011-0.024)	0.018 (0.012-0.027)	0.019 (0.012-0.029)

¹ Precipitation frequency (PF) estimates in this table are based on frequency analysis of partial duration series (PDS). Numbers in parenthesis are PF estimates at lower and upper bounds of the 90% confidence interval. The probability that precipitation frequency estimates (for a given duration and average recurrence interval) will be greater than the upper bound (or less than the lower bound) is 5%. Estimates at upper bounds are not checked against probable maximum precipitation (PMP) estimates and may be higher than currently valid PMP values. Please refer to NOAA Atlas 14 document for more information.

[Back to Top](#)

PF graphical

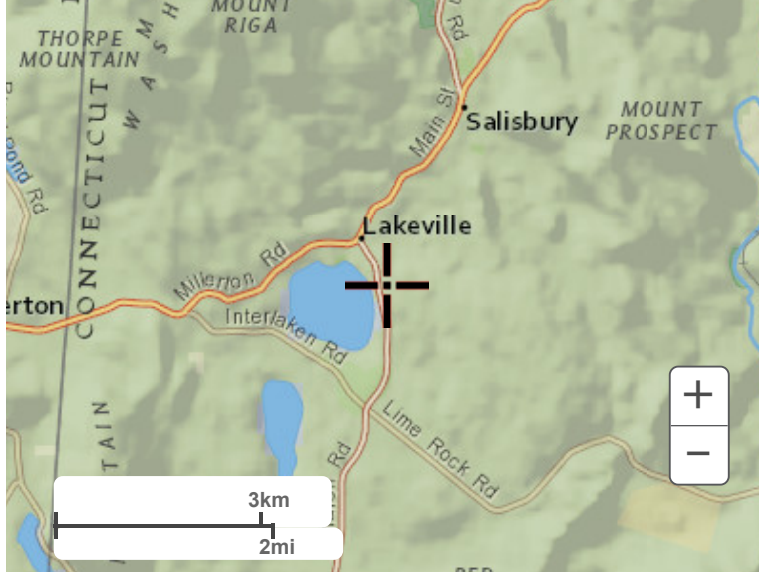

Large scale terrain



Large scale map

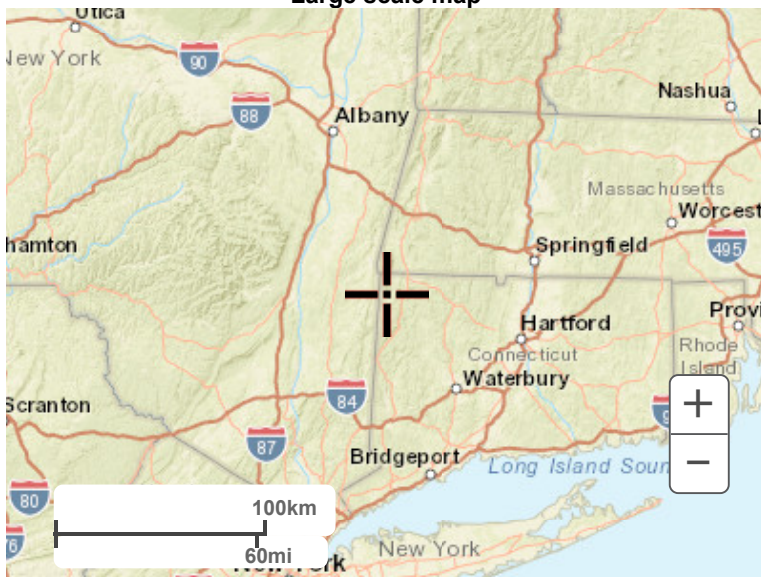

Large scale aerial

Storm Sewer IDF Curves

IDF file: Salisbury.IDF

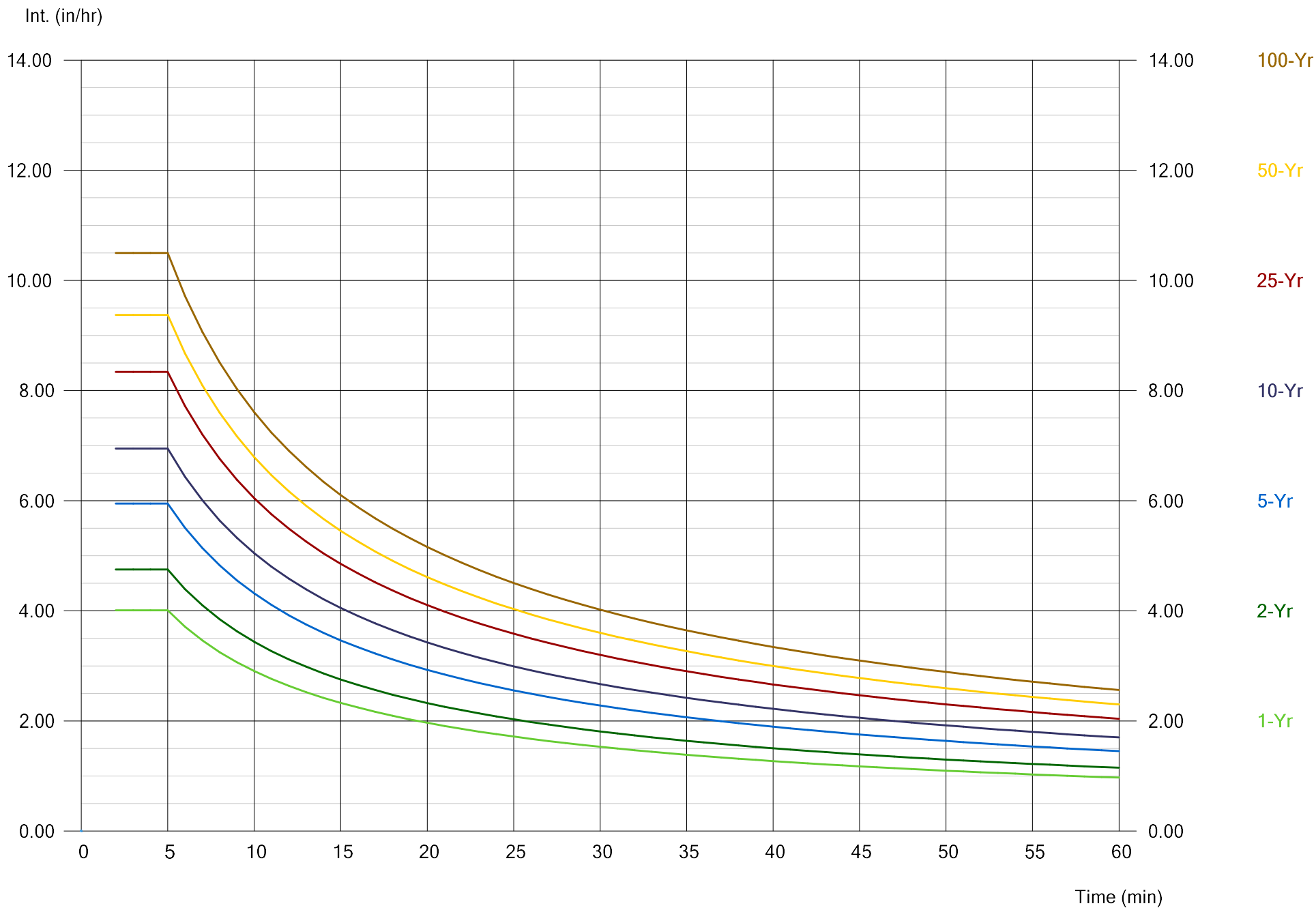

Hydraflow Storm Sewers Extension for Autodesk® Civil 3D® Plan

CLCB 2
4
Outfall

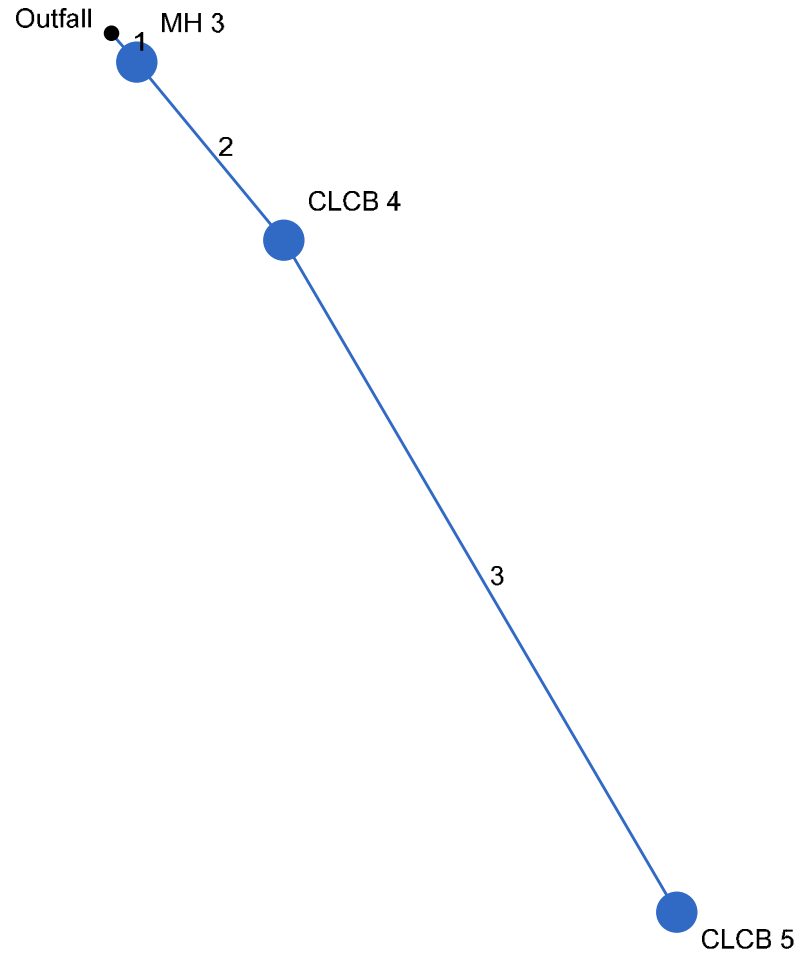
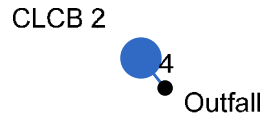

Project File: Storm 120.stm

Number of lines: 4

Date: 7/19/2024

Storm Sewer Inventory Report

Line No.	Alignment				Flow Data				Physical Data								Line ID
	Dnstr Line No.	Line Length (ft)	Defl angle (deg)	Junc Type	Known Q (cfs)	Drng Area (ac)	Runoff Coeff (C)	Inlet Time (min)	Invert El Dn (ft)	Line Slope (%)	Invert El Up (ft)	Line Size (in)	Line Shape	N Value (n)	J-Loss Coeff (K)	Inlet/ Rim El (ft)	
1	End	4.000	48.581	MH	0.00	0.00	0.00	5.0	817.50	7.50	817.80	12	Cir	0.012	0.15	828.30	Outfall-MH 3
2	1	24.000	2.021	Grate	0.31	0.06	0.77	5.0	825.00	2.92	825.70	12	Cir	0.012	0.50	829.40	MH 3-CLCB 4
3	2	81.000	9.189	Grate	0.31	0.23	0.66	5.0	825.70	3.21	828.30	12	Cir	0.012	1.00	832.00	CLCB 4-CLCB 5
4	End	4.000	-128.660	Grate	0.00	0.29	0.86	5.0	817.80	5.00	818.00	12	Cir	0.012	1.00	823.80	Outfall-CLCB 2
Project File: Storm 120.stm												Number of lines: 4				Date: 7/19/2024	

Storm Sewer Tabulation

Station		Len (ft)	Drng Area		Rnoff coeff (C)	Area x C		Tc		Rain (l) (in/hr)	Total flow (cfs)	Cap full (cfs)	Vel (ft/s)	Pipe		Invert Elev		HGL Elev		Grnd / Rim Elev		Line ID
Line	To Line		Incr (ac)	Total (ac)		Incr	Total	Inlet (min)	Syst (min)					Size (in)	Slope (%)	Dn (ft)	Up (ft)	Dn (ft)	Up (ft)	Dn (ft)	Up (ft)	
1	End	4.000	0.00	0.29	0.00	0.00	0.20	5.0	5.5	6.7	1.94	10.57	3.90	12	7.50	817.50	817.80	818.12	818.39	0.00	828.30	Outfall-MH 3
2	1	24.000	0.06	0.29	0.77	0.05	0.20	5.0	5.4	6.7	1.95	6.59	5.65	12	2.92	825.00	825.70	825.37	826.30	828.30	829.40	MH 3-CLCB 4
3	2	81.000	0.23	0.23	0.66	0.15	0.15	5.0	5.0	6.9	1.36	6.91	3.17	12	3.21	825.70	828.30	826.30	828.79	829.40	832.00	CLCB 4-CLCB 5
4	End	4.000	0.29	0.29	0.86	0.25	0.25	5.0	5.0	6.9	1.73	8.63	5.92	12	5.00	817.80	818.00	818.12	818.56	0.00	823.80	Outfall-CLCB 2

Project File: Storm 120.stm

Number of lines: 4

Run Date: 7/19/2024

NOTES: Intensity = $32.58 / (\text{Inlet time} + 3.80)^{0.71}$; Return period = Yrs. 10 ; c = cir e = ellip b = box

Inlet Report

Line No	Inlet ID	Q = CIA (cfs)	Q carry (cfs)	Q capt (cfs)	Q Byp (cfs)	Junc Type	Curb Inlet		Grate Inlet			Gutter						Inlet			Byp Line No		
							Ht (in)	L (ft)	Area (sqft)	L (ft)	W (ft)	So (ft/ft)	W (ft)	Sw (ft/ft)	Sx (ft/ft)	n	Depth (ft)	Spread (ft)	Depth (ft)	Spread (ft)		Depr (in)	
1	MH 3	0.00	0.00	0.00	0.00	MH	0.0	0.00	0.00	0.00	0.00	Sag	0.00	0.000	0.000	0.000	0.00	0.00	0.00	0.00	0.00	0.0	Off
2	CLCB 4	0.63*	0.28	0.79	0.12	Grate	0.0	0.00	0.00	2.31	1.35	0.053	2.53	0.068	0.068	0.013	0.15	2.19	0.07	1.02	0.0	Off	
3	CLCB 5	1.36*	0.00	1.08	0.28	Grate	0.0	0.00	0.00	2.31	1.35	0.050	2.53	0.067	0.067	0.013	0.17	2.60	0.10	1.44	0.0	2	
4	CLCB 2	1.73	0.00	1.73	0.00	Grate	0.0	0.00	3.12	2.31	1.35	Sag	2.53	0.062	0.062	0.000	0.28	4.49	0.28	4.49	0.0	Off	

Project File: Storm 120.stm

Number of lines: 4

Run Date: 7/19/2024

NOTES: Inlet N-Values = 0.016; Intensity = 32.58 / (Inlet time + 3.80) ^ 0.71; Return period = 10 Yrs. ; * Indicates Known Q added. All curb inlets are throat.

Hydraulic Grade Line Computations

Line	Size (in)	Q (cfs)	Downstream								Len (ft)	Upstream								Check		JL coeff (K)	Minor loss (ft)
			Invert elev (ft)	HGL elev (ft)	Depth (ft)	Area (sqft)	Vel (ft/s)	Vel head (ft)	EGL elev (ft)	Sf (%)		Invert elev (ft)	HGL elev (ft)	Depth (ft)	Area (sqft)	Vel (ft/s)	Vel head (ft)	EGL elev (ft)	Sf (%)	Ave Sf (%)	Enrgy loss (ft)		
1	12	1.94	817.50	818.12	0.62	0.49	3.80	0.25	818.37	0.000	4.000	817.80	818.39 j	0.59**	0.49	4.00	0.25	818.64	0.000	0.000	n/a	0.15	n/a
2	12	1.95	825.00	825.37	0.37*	0.27	7.30	0.25	825.62	0.000	24.000	825.70	826.30	0.60**	0.49	4.00	0.25	826.54	0.000	0.000	n/a	0.50	0.12
3	12	1.36	825.70	826.30	0.60	0.39	2.80	0.19	826.49	0.000	81.000	828.30	828.79 j	0.49**	0.39	3.53	0.19	828.99	0.000	0.000	n/a	1.00	0.19
4	12	1.73	817.80	818.12	0.32	0.22	8.00	0.23	818.35	0.000	4.000	818.00	818.56	0.56**	0.45	3.83	0.23	818.79	0.000	0.000	n/a	1.00	0.23

Project File: Storm 120.stm

Number of lines: 4

Run Date: 7/19/2024

Notes: * depth assumed; ** Critical depth.; j-Line contains hyd. jump ; c = cir e = ellip b = box

Hydraflow Storm Sewers Extension for Autodesk® Civil 3D® Plan

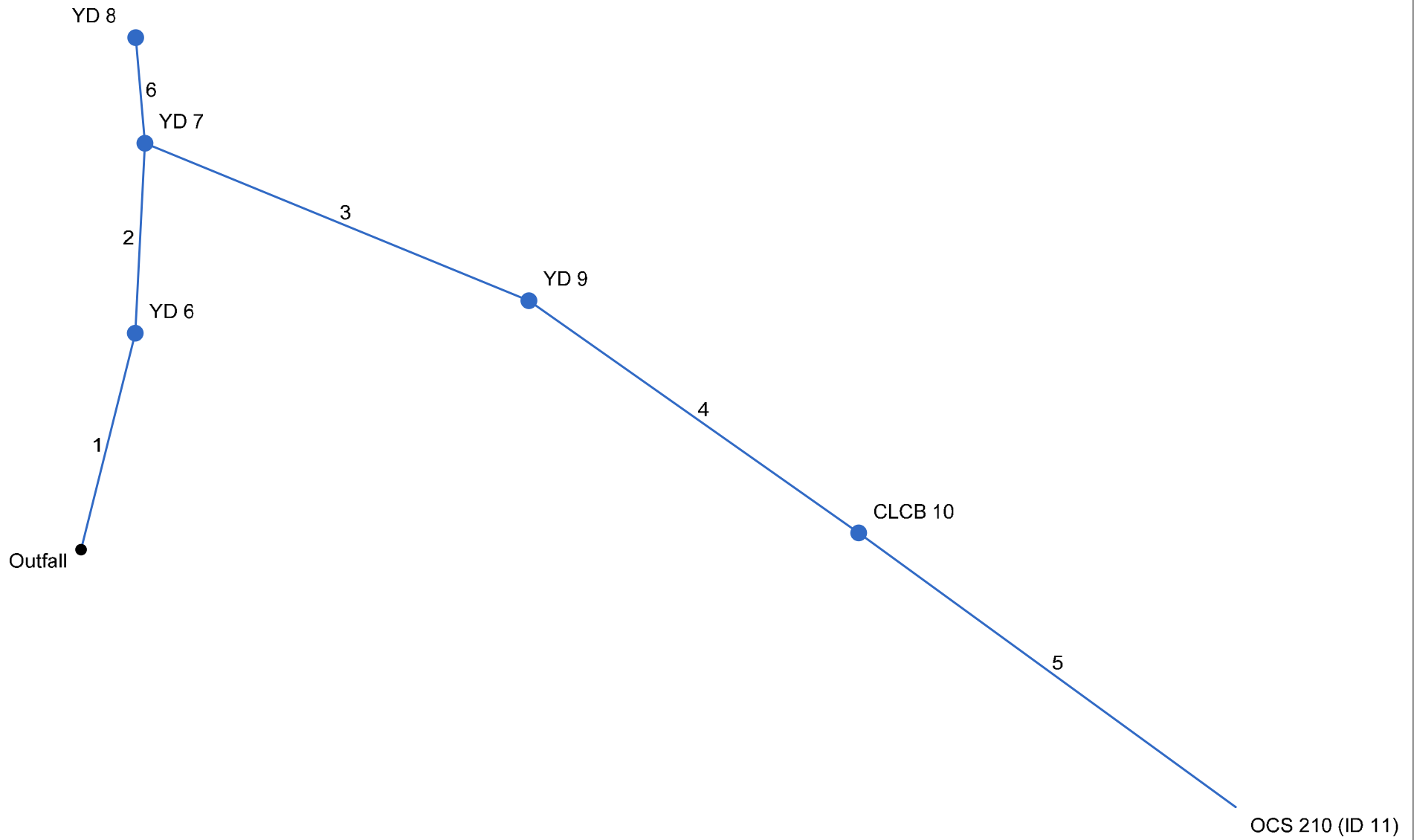

Storm Sewer Inventory Report

Line No.	Alignment				Flow Data				Physical Data								Line ID
	Dnstr Line No.	Line Length (ft)	Defl angle (deg)	Junc Type	Known Q (cfs)	Drng Area (ac)	Runoff Coeff (C)	Inlet Time (min)	Invert El Dn (ft)	Line Slope (%)	Invert El Up (ft)	Line Size (in)	Line Shape	N Value (n)	J-Loss Coeff (K)	Inlet/ Rim El (ft)	
1	End	61.000	-76.036	DrGrt	0.00	0.20	0.20	5.0	779.60	0.66	780.00	18	Cir	0.012	0.50	785.50	OUTFALL-YD 6
2	1	52.000	-11.033	DrGrt	0.00	0.51	0.30	5.0	780.00	0.58	780.30	18	Cir	0.012	1.50	784.20	YD 6-YD 7
3	2	113.000	109.470	DrGrt	0.00	0.17	0.56	5.0	780.30	8.58	790.00	15	Cir	0.012	0.50	795.60	YD 7-YD 9
4	3	110.000	12.881	Grate	0.00	0.76	0.52	5.0	790.30	10.00	801.30	12	Cir	0.012	0.50	809.70	YD 9-CLCB 10
5	4	127.000	0.853	None	2.20	0.00	0.00	5.0	806.70	6.77	815.30	12	Cir	0.012	1.00	2.40	CLCB 10-OCS 210 (I
6	2	29.000	-7.930	DrGrt	0.00	1.04	0.33	5.0	780.30	0.69	780.50	15	Cir	0.012	1.00	783.50	YD 7-YD 8

Project File: Storm 200.stm

Number of lines: 6

Date: 7/19/2024

Storm Sewer Tabulation

Station		Len (ft)	Drng Area		Rnoff coeff (C)	Area x C		Tc		Rain (l) (in/hr)	Total flow (cfs)	Cap full (cfs)	Vel (ft/s)	Pipe		Invert Elev		HGL Elev		Grnd / Rim Elev		Line ID
Line	To Line		Incr (ac)	Total (ac)		Incr	Total	Inlet (min)	Syst (min)					Size (in)	Slope (%)	Dn (ft)	Up (ft)	Dn (ft)	Up (ft)	Dn (ft)	Up (ft)	
1	End	61.000	0.20	2.68	0.20	0.04	1.03	5.0	6.1	6.4	8.77	9.21	5.01	18	0.66	779.60	780.00	781.10	781.42	0.00	785.50	OUTFALL-YD 6
2	1	52.000	0.51	2.48	0.30	0.15	0.99	5.0	5.9	6.5	8.59	8.64	4.86	18	0.58	780.00	780.30	781.62	781.92	785.50	784.20	YD 6-YD 7
3	2	113.000	0.17	0.93	0.56	0.10	0.49	5.0	5.5	6.7	5.47	20.50	4.97	15	8.58	780.30	790.00	782.47	790.95	784.20	795.60	YD 7-YD 9
4	3	110.000	0.76	0.76	0.52	0.40	0.40	5.0	5.3	6.8	4.88	12.20	7.79	12	10.00	790.30	801.30	790.95	802.21	795.60	809.70	YD 9-CLCB 10
5	4	127.000	0.00	0.00	0.00	0.00	0.00	5.0	5.0	0.0	2.20	10.04	7.22	12	6.77	806.70	815.30	807.02	815.93	809.70	2.40	CLCB 10-OCS 21
6	2	29.000	1.04	1.04	0.33	0.34	0.34	5.0	5.0	6.9	2.38	5.81	1.94	15	0.69	780.30	780.50	782.47	782.50	784.20	783.50	YD 7-YD 8

Project File: Storm 200.stm

Number of lines: 6

Run Date: 7/19/2024

NOTES: Intensity = $32.58 / (\text{Inlet time} + 3.80)^{0.71}$; Return period = Yrs. 10 ; c = cir e = ellip b = box

Inlet Report

Line No	Inlet ID	Q = CIA (cfs)	Q carry (cfs)	Q capt (cfs)	Q Byp (cfs)	Junc Type	Curb Inlet		Grate Inlet			Gutter						Inlet			Byp Line No	
							Ht (in)	L (ft)	Area (sqft)	L (ft)	W (ft)	So (ft/ft)	W (ft)	Sw (ft/ft)	Sx (ft/ft)	n	Depth (ft)	Spread (ft)	Depth (ft)	Spread (ft)		Depr (in)
1	YD 6	0.28	0.00	0.28	0.00	DrGrt	0.0	0.00	1.51	1.23	1.23	Sag	2.00	0.083	0.083	0.000	0.07	3.70	0.07	3.70	0.0	Off
2	YD 7	1.06	0.00	0.39	0.67	DrGrt	0.0	0.00	0.00	1.23	1.23	0.056	2.00	0.066	0.066	0.013	0.09	4.76	0.09	4.76	0.0	Off
3	YD 9	0.66	0.00	0.38	0.28	DrGrt	0.0	0.00	0.00	1.23	1.23	0.120	2.00	0.400	0.400	0.013	0.06	2.31	0.06	2.31	0.0	Off
4	CLCB 10	2.75	0.00	1.36	1.39	Grate	0.0	0.00	0.00	1.23	1.23	0.109	2.00	0.100	0.100	0.013	0.23	2.28	0.18	1.76	0.0	Off
5	OCS 210 (ID 11)	2.20*	0.00	0.00	2.20	None	0.0	0.00	0.00	0.00	0.00	Sag	0.00	0.000	0.000	0.000	0.00	0.00	0.00	0.00	0.0	Off
6	YD 8	2.38	0.00	0.42	1.96	DrGrt	0.0	0.00	0.00	1.23	1.23	0.028	2.00	0.020	0.020	0.013	0.11	13.10	0.11	13.10	0.0	Off

Project File: Storm 200.stm

Number of lines: 6

Run Date: 7/19/2024

NOTES: Inlet N-Values = 0.016; Intensity = 32.58 / (Inlet time + 3.80) ^ 0.71; Return period = 10 Yrs. ; * Indicates Known Q added. All curb inlets are throat.

Hydraulic Grade Line Computations

Line	Size (in)	Q (cfs)	Downstream								Len (ft)	Upstream								Check		JL coeff (K)	Minor loss (ft)
			Invert elev (ft)	HGL elev (ft)	Depth (ft)	Area (sqft)	Vel (ft/s)	Vel head (ft)	EGL elev (ft)	Sf (%)		Invert elev (ft)	HGL elev (ft)	Depth (ft)	Area (sqft)	Vel (ft/s)	Vel head (ft)	EGL elev (ft)	Sf (%)	Ave Sf (%)	Enrgy loss (ft)		
1	18	8.77	779.60	781.10	1.50	1.77	4.96	0.38	781.48	0.594	61.000	780.00	781.42	1.42	1.73	5.06	0.40	781.82	0.514	0.554	0.338	0.50	0.20
2	18	8.59	780.00	781.62	1.50	1.77	4.86	0.37	781.99	0.571	52.000	780.30	781.92	1.50	1.77	4.86	0.37	782.29	0.571	0.571	0.297	1.50	0.55
3	15	5.47	780.30	782.47	1.25	1.00	4.46	0.31	782.78	0.611	113.000	790.00	790.95 j	0.95**	1.00	5.48	0.47	791.41	0.718	0.665	n/a	0.50	0.23
4	12	4.88	790.30	790.95	0.65	0.54	9.08	0.66	791.61	0.000	110.000	801.30	802.21	0.91**	0.75	6.51	0.66	802.87	0.000	0.000	n/a	0.50	n/a
5	12	2.20	806.70	807.02	0.32*	0.21	10.24	0.27	807.29	0.000	127.000	815.30	815.93	0.63**	0.52	4.19	0.27	816.21	0.000	0.000	n/a	1.00	n/a
6	15	2.38	780.30	782.47	1.25	1.23	1.94	0.06	782.53	0.116	29.000	780.50	782.50	1.25	1.23	1.94	0.06	782.56	0.116	0.116	0.034	1.00	0.06

Project File: Storm 200.stm

Number of lines: 6

Run Date: 7/19/2024

Notes: * depth assumed; ** Critical depth.; j-Line contains hyd. jump ; c = cir e = ellip b = box

Hydraflow Storm Sewers Extension for Autodesk® Civil 3D® Plan

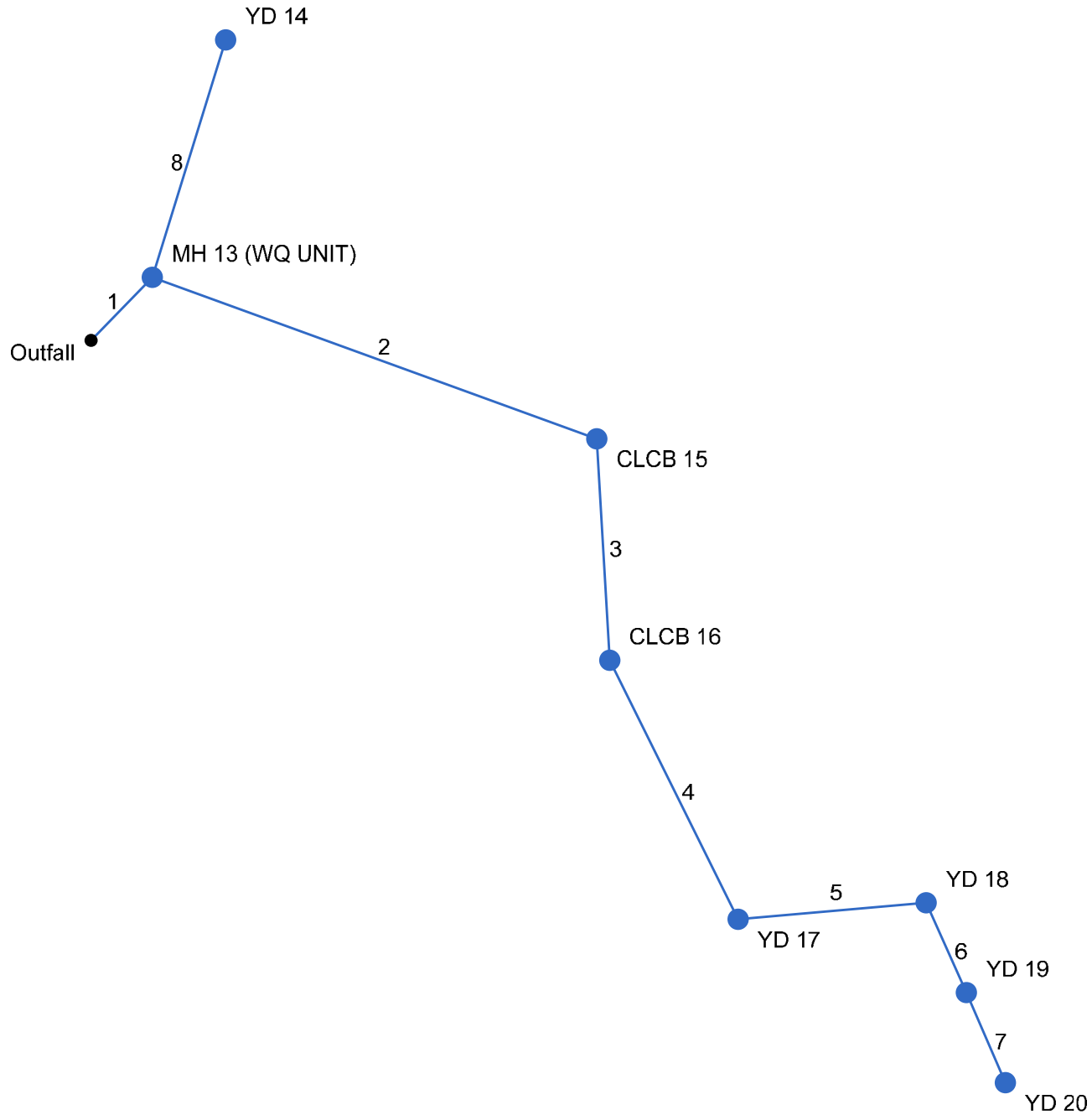

Project File: Storm 210.stm

Number of lines: 8

Date: 7/19/2024

Storm Sewer Inventory Report

Line No.	Alignment				Flow Data				Physical Data								Line ID
	Dnstr Line No.	Line Length (ft)	Defl angle (deg)	Junc Type	Known Q (cfs)	Drng Area (ac)	Runoff Coeff (C)	Inlet Time (min)	Invert El Dn (ft)	Line Slope (%)	Invert El Up (ft)	Line Size (in)	Line Shape	N Value (n)	J-Loss Coeff (K)	Inlet/ Rim El (ft)	
1	End	21.000	-51.914	MH	0.00	0.00	0.00	5.0	815.00	3.81	815.80	12	Cir	0.012	0.98	819.00	FES 12-MH 13 (WQ U
2	1	103.000	76.135	Grate	0.00	0.51	0.64	5.0	815.80	8.25	824.30	12	Cir	0.012	1.37	829.00	MH 13 (WQ UNIT)-CL
3	2	58.000	63.052	Grate	1.65	0.18	0.56	5.0	826.00	2.93	827.70	12	Cir	0.012	0.57	830.70	CLCB 15-CLCB 16
4	3	73.000	-19.070	DrGrt	0.00	0.23	0.45	5.0	827.70	4.11	830.70	12	Cir	0.012	1.46	833.70	CLCB 16-YD 17
5	4	40.000	-74.461	DrGrt	0.00	0.01	0.90	5.0	830.70	10.75	835.00	8	Cir	0.012	1.47	842.00	YD 17-YD 18
6	5	25.000	76.411	DrGrt	0.00	0.01	0.90	5.0	838.00	2.00	838.50	8	Cir	0.012	0.50	842.00	YD 18-YD 19
7	6	25.000	0.535	DrGrt	0.00	0.01	0.90	5.0	838.50	2.00	839.00	8	Cir	0.012	1.00	842.00	YD 19-YD 20
8	1	64.000	-24.076	DrGrt	0.63	0.03	0.49	5.0	815.50	2.34	817.00	12	Cir	0.012	1.00	821.20	MH 13 (WQ UNIT)-YD

Project File: Storm 210.stm

Number of lines: 8

Date: 7/19/2024

Storm Sewer Tabulation

Station		Len (ft)	Drng Area		Rnoff coeff (C)	Area x C		Tc		Rain (l) (in/hr)	Total flow (cfs)	Cap full (cfs)	Vel (ft/s)	Pipe		Invert Elev		HGL Elev		Grnd / Rim Elev		Line ID
Line	To Line		Incr (ac)	Total (ac)		Incr	Total	Inlet (min)	Syst (min)					Size (in)	Slope (%)	Dn (ft)	Up (ft)	Dn (ft)	Up (ft)	Dn (ft)	Up (ft)	
1	End	21.000	0.00	0.98	0.00	0.00	0.57	5.0	6.9	6.0	5.74	7.53	7.46	12	3.81	815.00	815.80	815.95	816.75	817.36	819.00	FES 12-MH 13 (W
2	1	103.000	0.51	0.95	0.64	0.33	0.56	5.0	6.6	6.2	5.08	11.08	6.66	12	8.25	815.80	824.30	816.75	825.22	819.00	829.00	MH 13 (WQ UNIT)
3	2	58.000	0.18	0.44	0.56	0.10	0.23	5.0	6.5	6.2	3.09	6.61	6.57	12	2.93	826.00	827.70	826.48	828.45	829.00	830.70	CLCB 15-CLCB 1
4	3	73.000	0.23	0.26	0.45	0.10	0.13	5.0	5.9	6.5	0.84	7.82	2.18	12	4.11	827.70	830.70	828.45	831.08	830.70	833.70	CLCB 16-YD 17
5	4	40.000	0.01	0.03	0.90	0.01	0.03	5.0	5.5	6.7	0.18	4.29	1.50	8	10.75	830.70	835.00	831.08	835.19	833.70	842.00	YD 17-YD 18
6	5	25.000	0.01	0.02	0.90	0.01	0.02	5.0	5.3	6.8	0.12	1.85	2.45	8	2.00	838.00	838.50	838.12	838.66	842.00	842.00	YD 18-YD 19
7	6	25.000	0.01	0.01	0.90	0.01	0.01	5.0	5.0	6.9	0.06	1.85	1.28	8	2.00	838.50	839.00	838.66	839.11	842.00	842.00	YD 19-YD 20
8	1	64.000	0.03	0.03	0.49	0.01	0.01	5.0	5.0	6.9	0.73	5.91	1.92	12	2.34	815.50	817.00	816.75	817.36	819.00	821.20	MH 13 (WQ UNIT)

Project File: Storm 210.stm

Number of lines: 8

Run Date: 7/19/2024

NOTES: Intensity = 32.58 / (Inlet time + 3.80) ^ 0.71; Return period = Yrs. 10 ; c = cir e = ellip b = box

Inlet Report

Line No	Inlet ID	Q = CIA (cfs)	Q carry (cfs)	Q capt (cfs)	Q Byp (cfs)	Junc Type	Curb Inlet		Grate Inlet			Gutter						Inlet			Byp Line No		
							Ht (in)	L (ft)	Area (sqft)	L (ft)	W (ft)	So (ft/ft)	W (ft)	Sw (ft/ft)	Sx (ft/ft)	n	Depth (ft)	Spread (ft)	Depth (ft)	Spread (ft)		Depr (in)	
1	MH 13 (WQ UNIT)	0.00	0.00	0.00	0.00	MH	0.0	0.00	0.00	0.00	0.00	Sag	0.00	0.000	0.000	0.000	0.00	0.00	0.00	0.00	0.00	0.0	Off
2	CLCB 15	2.27	0.67	2.94	0.00	Grate	0.0	0.00	3.12	2.31	1.35	Sag	2.53	0.012	0.012	0.000	0.34	28.74	0.34	28.74	0.0	Off	
3	CLCB 16	2.35*	0.00	1.68	0.67	Grate	0.0	0.00	0.00	2.31	1.35	0.037	2.53	0.071	0.071	0.013	0.23	3.26	0.14	2.04	0.0	2	
4	YD 17	0.72	0.00	0.72	0.00	DrGrt	0.0	0.00	1.51	1.23	1.23	Sag	2.00	0.091	0.091	0.000	0.13	4.93	0.13	4.93	0.0	Off	
5	YD 18	0.06	0.00	0.06	0.00	DrGrt	0.0	0.00	1.51	1.23	1.23	Sag	2.00	0.010	0.010	0.000	0.03	7.23	0.03	7.23	0.0	Off	
6	YD 19	0.06	0.00	0.06	0.00	DrGrt	0.0	0.00	1.51	1.23	1.23	Sag	2.00	0.010	0.010	0.000	0.03	7.23	0.03	7.23	0.0	Off	
7	YD 20	0.06	0.00	0.06	0.00	DrGrt	0.0	0.00	1.51	1.23	1.23	Sag	2.00	0.010	0.010	0.000	0.03	7.23	0.03	7.23	0.0	Off	
8	YD 14	0.73*	0.00	0.27	0.46	DrGrt	0.0	0.00	0.00	1.23	1.23	0.010	2.00	0.070	0.070	0.013	0.11	5.17	0.11	5.17	0.0	Off	

Project File: Storm 210.stm

Number of lines: 8

Run Date: 7/19/2024

NOTES: Inlet N-Values = 0.016; Intensity = 32.58 / (Inlet time + 3.80) ^ 0.71; Return period = 10 Yrs. ; * Indicates Known Q added. All curb inlets are throat.

Hydraulic Grade Line Computations

Line	Size (in)	Q (cfs)	Downstream								Len (ft)	Upstream								Check		JL coeff (K)	Minor loss (ft)
			Invert elev (ft)	HGL elev (ft)	Depth (ft)	Area (sqft)	Vel (ft/s)	Vel head (ft)	EGL elev (ft)	Sf (%)		Invert elev (ft)	HGL elev (ft)	Depth (ft)	Area (sqft)	Vel (ft/s)	Vel head (ft)	EGL elev (ft)	Sf (%)	Ave Sf (%)	Enrgy loss (ft)		
1	12	5.74	815.00	815.95	0.95	0.77	7.46	0.87	816.81	0.000	21.000	815.80	816.75	0.95**	0.77	7.46	0.87	817.61	0.000	0.000	n/a	0.98	0.85
2	12	5.08	815.80	816.75	0.95	0.76	6.60	0.70	817.45	0.000	103.000	824.30	825.22 j	0.92**	0.76	6.72	0.70	825.92	0.000	0.000	n/a	1.37	n/a
3	12	3.09	826.00	826.48	0.48*	0.37	8.26	0.37	826.85	0.000	58.000	827.70	828.45	0.75**	0.63	4.87	0.37	828.82	0.000	0.000	n/a	0.57	n/a
4	12	0.84	827.70	828.45	0.75	0.28	1.33	0.14	828.60	0.000	73.000	830.70	831.08 j	0.38**	0.28	3.04	0.14	831.23	0.000	0.000	n/a	1.46	n/a
5	8	0.18	830.70	831.08	0.38	0.08	0.87	0.07	831.15	0.000	40.000	835.00	835.19 j	0.19**	0.08	2.13	0.07	835.27	0.000	0.000	n/a	1.47	0.10
6	8	0.12	838.00	838.12	0.12*	0.04	3.00	0.06	838.17	0.000	25.000	838.50	838.66	0.16**	0.06	1.91	0.06	838.72	0.000	0.000	n/a	0.50	0.03
7	8	0.06	838.50	838.66	0.16	0.04	0.98	0.04	838.70	0.000	25.000	839.00	839.11 j	0.11**	0.04	1.59	0.04	839.15	0.000	0.000	n/a	1.00	0.04
8	12	0.73	815.50	816.75	1.00	0.25	0.93	0.01	816.76	0.036	64.000	817.00	817.36 j	0.36**	0.25	2.91	0.13	817.49	0.484	0.260	n/a	1.00	n/a

Project File: Storm 210.stm

Number of lines: 8

Run Date: 7/19/2024

Notes: * depth assumed; ** Critical depth.; j-Line contains hyd. jump ; c = cir e = ellip b = box

Hydraflow Storm Sewers Extension for Autodesk® Civil 3D® Plan

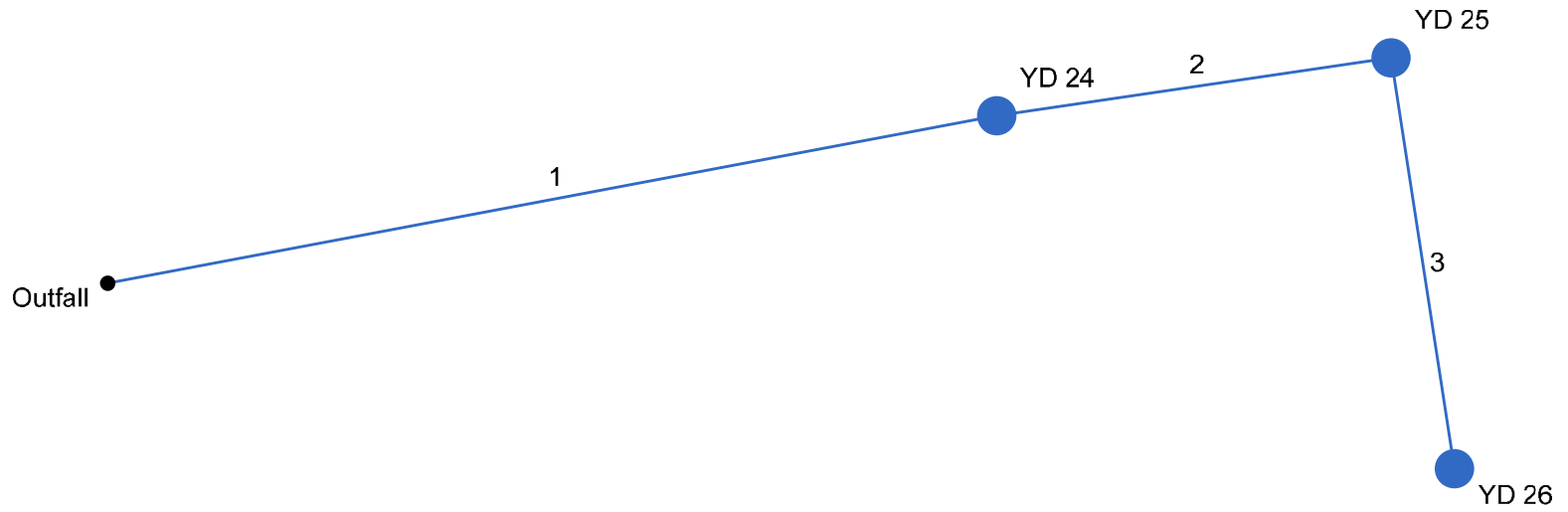

Storm Sewer Inventory Report

Line No.	Alignment				Flow Data				Physical Data								Line ID
	Dnstr Line No.	Line Length (ft)	Defl angle (deg)	Junc Type	Known Q (cfs)	Drng Area (ac)	Runoff Coeff (C)	Inlet Time (min)	Invert El Dn (ft)	Line Slope (%)	Invert El Up (ft)	Line Size (in)	Line Shape	N Value (n)	J-Loss Coeff (K)	Inlet/ Rim El (ft)	
1	End	99.139	-10.814	DrGrt	0.00	0.16	0.48	5.0	803.00	3.53	806.50	8	Cir	0.012	0.50	809.50	FES 23-YD 24
2	1	43.708	2.327	DrGrt	0.00	0.19	0.61	5.0	806.50	5.72	809.00	8	Cir	0.012	1.50	811.90	YD 24-YD 25
3	2	46.213	89.858	DrGrt	0.00	0.03	0.42	5.0	809.00	6.49	812.00	8	Cir	0.012	1.00	815.00	YD 25-YD 26
Project File: Storm 220.stm												Number of lines: 3				Date: 7/19/2024	

Storm Sewer Tabulation

Station		Len (ft)	Drng Area		Rnoff coeff (C)	Area x C		Tc		Rain (l) (in/hr)	Total flow (cfs)	Cap full (cfs)	Vel (ft/s)	Pipe		Invert Elev		HGL Elev		Grnd / Rim Elev		Line ID
Line	To Line		Incr (ac)	Total (ac)		Incr	Total	Inlet (min)	Syst (min)					Size (in)	Slope (%)	Dn (ft)	Up (ft)	Dn (ft)	Up (ft)	Dn (ft)	Up (ft)	
1	End	99.139	0.16	0.38	0.48	0.08	0.21	5.0	6.0	6.5	1.32	2.46	5.76	8	3.53	803.00	806.50	803.35	807.04	803.71	809.50	FES 23-YD 24
2	1	43.708	0.19	0.22	0.61	0.12	0.13	5.0	5.7	6.6	0.84	3.13	3.14	8	5.72	806.50	809.00	807.04	809.43	809.50	811.90	YD 24-YD 25
3	2	46.213	0.03	0.03	0.42	0.01	0.01	5.0	5.0	6.9	0.09	3.33	1.05	8	6.49	809.00	812.00	809.43	812.13	811.90	815.00	YD 25-YD 26

Project File: Storm 220.stm

Number of lines: 3

Run Date: 7/19/2024

NOTES: Intensity = $32.58 / (\text{Inlet time} + 3.80)^{0.71}$; Return period = Yrs. 10 ; c = cir e = ellip b = box

Inlet Report

Line No	Inlet ID	Q = CIA (cfs)	Q carry (cfs)	Q capt (cfs)	Q Byp (cfs)	Junc Type	Curb Inlet		Grate Inlet			Gutter						Inlet			Byp Line No	
							Ht (in)	L (ft)	Area (sqft)	L (ft)	W (ft)	So (ft/ft)	W (ft)	Sw (ft/ft)	Sx (ft/ft)	n	Depth (ft)	Spread (ft)	Depth (ft)	Spread (ft)		Depr (in)
1	YD 24	0.53	0.01	0.40	0.14	DrGrt	0.0	0.00	0.00	1.96	1.96	0.037	2.00	0.143	0.143	0.030	0.11	3.55	0.11	3.55	0.0	Off
2	YD 25	0.81	0.00	0.64	0.17	DrGrt	0.0	0.00	0.00	1.96	1.96	0.135	2.00	0.200	0.200	0.030	0.10	3.01	0.10	3.01	0.0	Off
3	YD 26	0.09	0.00	0.08	0.01	DrGrt	0.0	0.00	0.00	1.96	1.96	0.143	2.00	0.150	0.150	0.030	0.03	2.41	0.03	2.41	0.0	1

Project File: Storm 220.stm

Number of lines: 3

Run Date: 7/19/2024

NOTES: Inlet N-Values = 0.016; Intensity = 32.58 / (Inlet time + 3.80) ^ 0.71; Return period = 10 Yrs. ; * Indicates Known Q added. All curb inlets are throat.

Hydraulic Grade Line Computations

Line	Size (in)	Q (cfs)	Downstream								Len (ft)	Upstream								Check		JL coeff (K)	Minor loss (ft)
			Invert elev (ft)	HGL elev (ft)	Depth (ft)	Area (sqft)	Vel (ft/s)	Vel head (ft)	EGL elev (ft)	Sf (%)		Invert elev (ft)	HGL elev (ft)	Depth (ft)	Area (sqft)	Vel (ft/s)	Vel head (ft)	EGL elev (ft)	Sf (%)	Ave Sf (%)	Enrgy loss (ft)		
1	8	1.32	803.00	803.35	0.35	0.18	7.17	0.29	803.64	0.000	99.139	806.50	807.04	0.54**	0.30	4.35	0.29	807.34	0.000	0.000	n/a	0.50	0.15
2	8	0.84	806.50	807.04	0.54	0.24	2.77	0.19	807.23	0.000	43.708	809.00	809.43 j	0.43**	0.24	3.50	0.19	809.63	0.000	0.000	n/a	1.50	n/a
3	8	0.09	809.00	809.43	0.43	0.05	0.36	0.05	809.48	0.000	46.213	812.00	812.13 j	0.13**	0.05	1.74	0.05	812.18	0.000	0.000	n/a	1.00	n/a

Project File: Storm 220.stm

Number of lines: 3

Run Date: 7/19/2024

Notes: ; ** Critical depth.; j-Line contains hyd. jump ; c = cir e = ellip b = box

Channel Report

Outlet 120

Circular

Diameter (ft) = 1.00

Invert Elev (ft) = 814.00

Slope (%) = 3.03

N-Value = 0.012

Calculations

Compute by: Known Q

Known Q (cfs) = 6.49

Highlighted

Depth (ft) = 0.80

Q (cfs) = 6.490

Area (sqft) = 0.67

Velocity (ft/s) = 9.63

Wetted Perim (ft) = 2.22

Crit Depth, Y_c (ft) = 0.97

Top Width (ft) = 0.80

EGL (ft) = 2.24

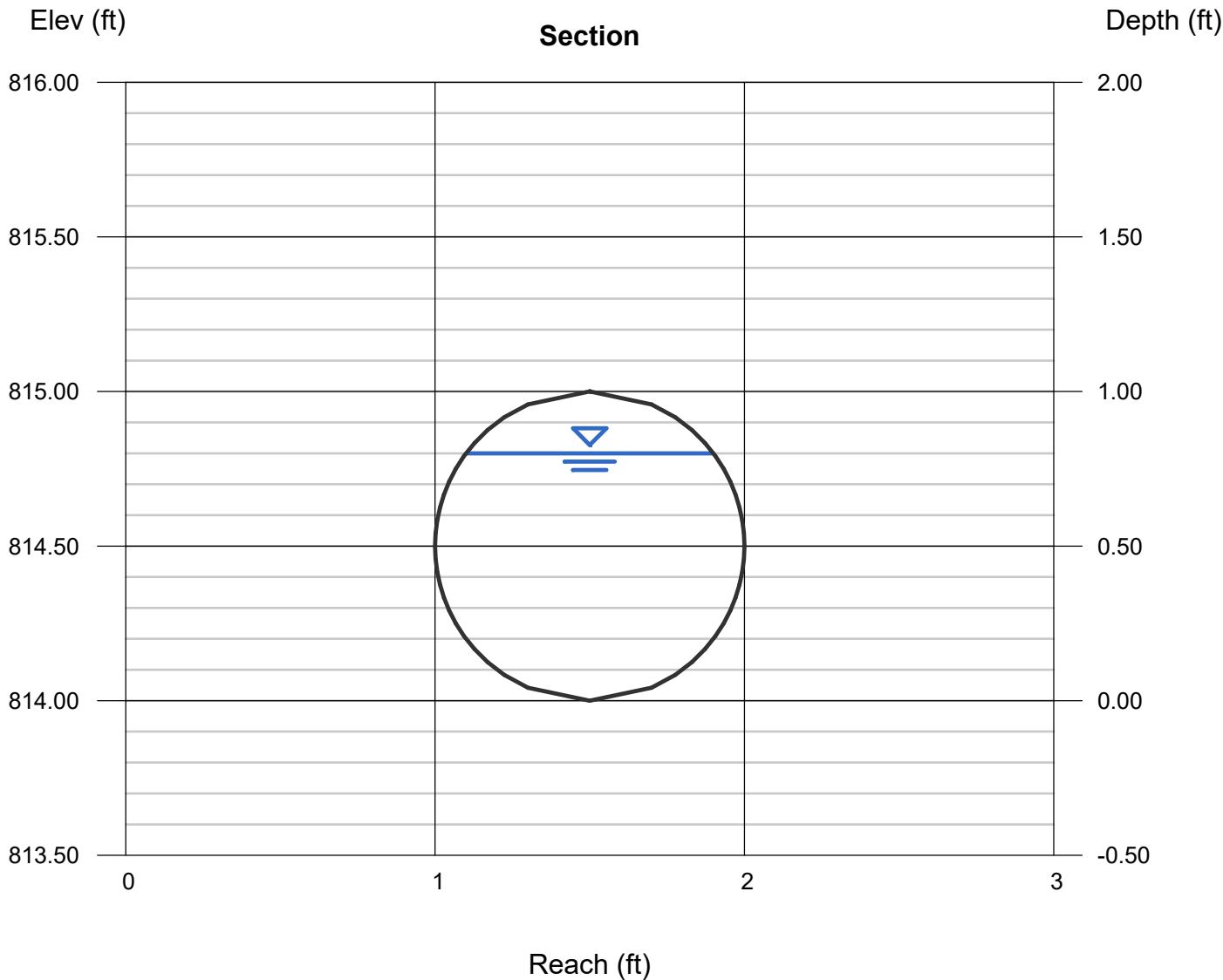

Channel Report

Outlet 220

Circular

Diameter (ft) = 1.25

Invert Elev (ft) = 800.00
Slope (%) = 1.25
N-Value = 0.012

Highlighted

Depth (ft) = 0.85
Q (cfs) = 6.270
Area (sqft) = 0.89
Velocity (ft/s) = 7.05
Wetted Perim (ft) = 2.42
Crit Depth, Y_c (ft) = 1.02
Top Width (ft) = 1.17
EGL (ft) = 1.62

Calculations

Compute by: Known Q
Known Q (cfs) = 6.27

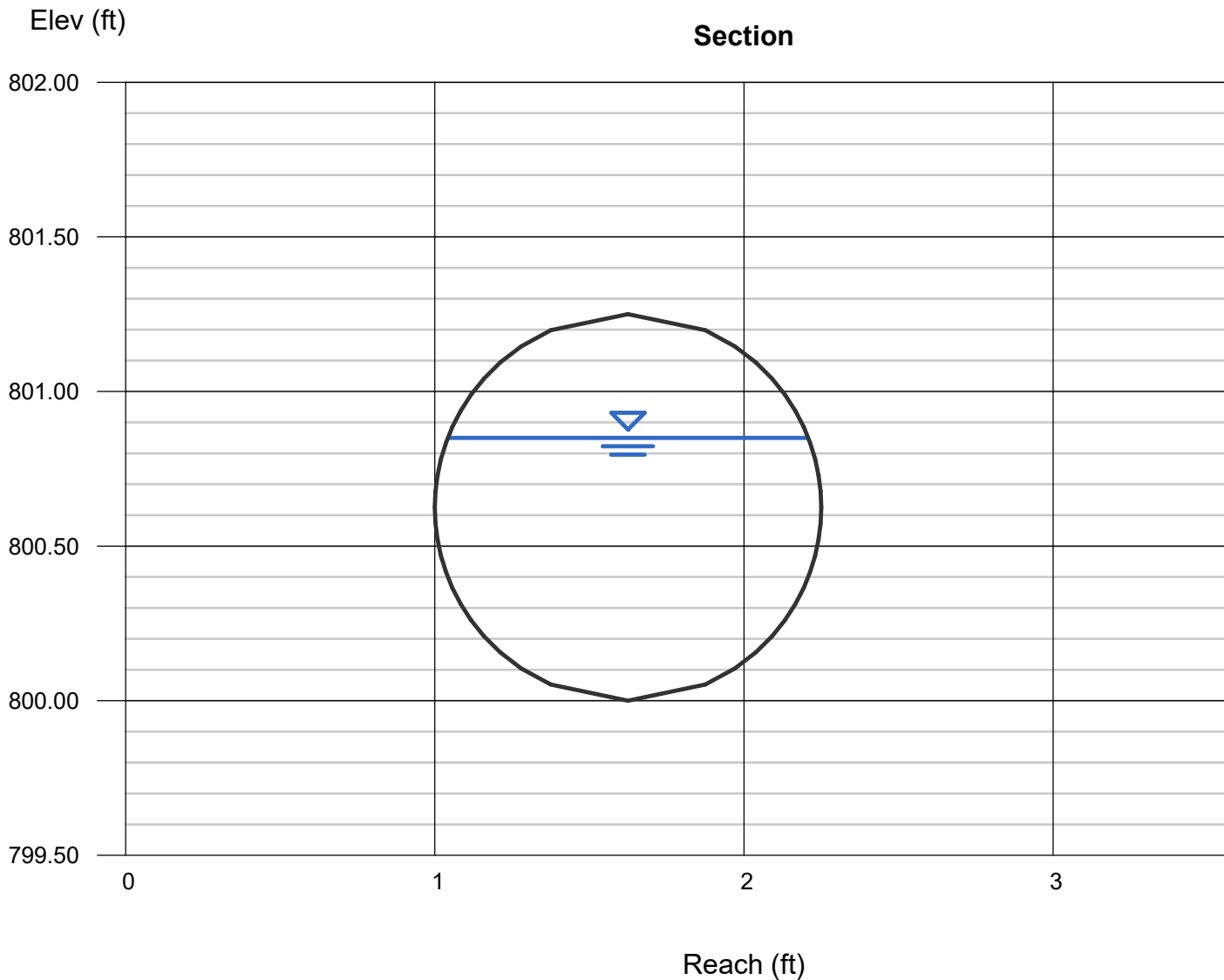

Culvert Report

CULVERT

Invert Elev Dn (ft)	= 825.80
Pipe Length (ft)	= 32.00
Slope (%)	= 0.63
Invert Elev Up (ft)	= 826.00
Rise (in)	= 15.0
Shape	= Circular
Span (in)	= 15.0
No. Barrels	= 2
n-Value	= 0.013
Culvert Type	= Circular Concrete
Culvert Entrance	= Groove end projecting (C)
Coeff. K,M,c,Y,k	= 0.0045, 2, 0.0317, 0.69, 0.2

Embankment	
Top Elevation (ft)	= 827.80
Top Width (ft)	= 17.00
Crest Width (ft)	= 23.00

Calculations	
Qmin (cfs)	= 11.30
Qmax (cfs)	= 11.30
Tailwater Elev (ft)	= (dc+D)/2

Highlighted	
Qtotal (cfs)	= 11.30
Qpipe (cfs)	= 11.30
Qovertop (cfs)	= 0.00
Veloc Dn (ft/s)	= 4.92
Veloc Up (ft/s)	= 5.58
HGL Dn (ft)	= 826.91
HGL Up (ft)	= 826.96
Hw Elev (ft)	= 827.54
Hw/D (ft)	= 1.23
Flow Regime	= Inlet Control

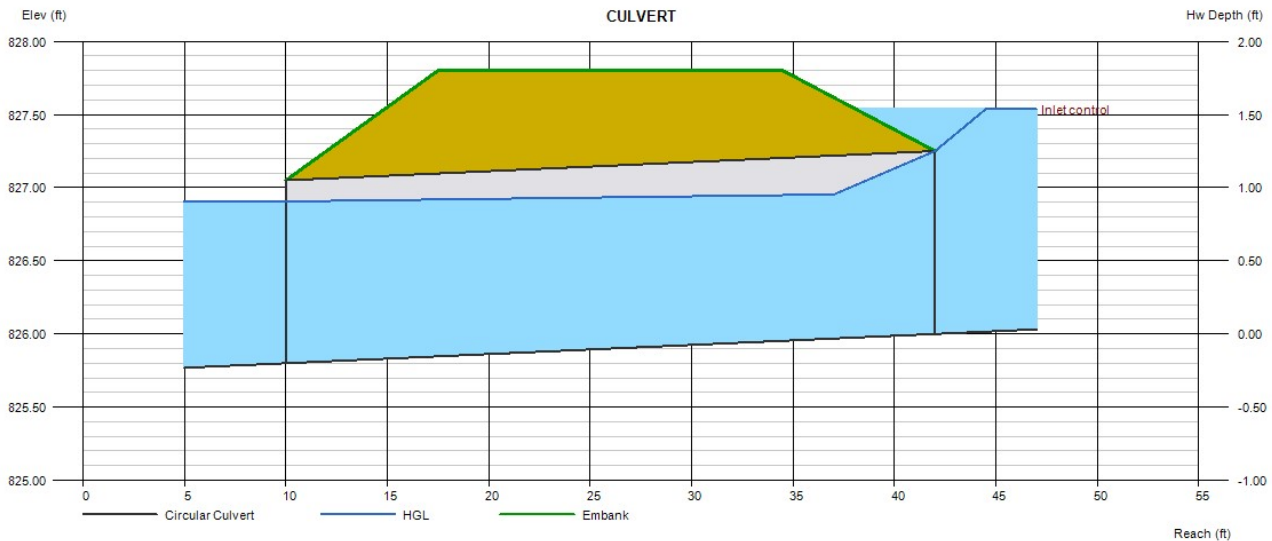

Outlet Protection Calculations

<u>Project:</u> Wake Robin Inn	<u>By:</u> MCB	<u>Date:</u> 7/19/2024
<u>Location:</u> Salisbury, CT	<u>Checked:</u>	<u>Date:</u>
<u>Outlet I.D.:</u> FES 1		

*Based on Connecticut DOT Drainage Manual, Section 11.13

Description:

FES 1

Design Criteria (100-yr Storm Event):

Q (cfs) = 6.49	R _p (ft)=	1
D (in) = 12	S _p (ft) =	1
V (fps) = 9.63	T _w (ft)=	1

Q= Flow rate at discharge point in cubic feet per second (cfs)

D= Outlet pipe diameter (in)

V= Flow velocity at discharge point (ft/s)

R_p= Maximum inside pipe rise (ft)

S_p= inside diameters for circular sections of maximum inside pipe span for non-circular sections (ft)

T_w= Tailwater depth (ft)

Based on **Table 11.13.1**, A *Preformed Scour Hole* is used *One Half Pipe Rise Depression (Type I)*

Rip Rap Stone Size:

<u>D₅₀ Computed (ft)</u>	<u>Rip Rap Specification</u>	<u>D₅₀ Stone Size Required</u>
0.150	Modified	5 inches

Preformed Scour Hole Dimensions:

F = 0.5(R _p)	=	0.5 ft
C = 3.0(S _p)+6.0(F)	=	6ft
B = 2.0(S _p)+6.0(F)	=	5ft
d (Depth of Stone)	=	12 inches

Outlet Protection Calculations

Project: Wake Robin Inn
Location: Salisbury, CT
Outlet I.D.: **FES 12**

By: MCB
Checked:
Date: 07/19/24
Date:

*Based on Connecticut DOT Drainage Manual, Section 11.13

Description:

FES 12

Design Criteria (10-yr Storm Event):

Q (cfs) = 5.7 R_p (ft) = 1
D (in) = 12 S_p (ft) = 1
V (fps) = 7.46 T_w (ft) = 1.75

Q= Flow rate at discharge point in cubic feet per second (cfs)
D= Outlet pipe diameter (in)
V= Flow velocity at discharge point (ft/s)
 R_p = Maximum inside pipe rise (ft)
 S_p = inside diameters for circular sections of maximum inside pipe span for non-circular sections (ft)
 T_w = Tailwater depth (ft)

Based on **Table 11-13.1** use Type 'B' ----> $TW \geq 0.5 R_p$

Rip Rap Stone Size:

<u>Velocity</u>	<u>Rip Rap Specification</u>	<u>D_{50} Stone Size</u>
0-8 fps	Modified	5 inches

Preformed Scour Hole Dimensions:

F (ft) = $0.5(R_p)$ = n/a
 C (ft) = $3.0(S_p) + 6.0(F)$ = n/a
 B (ft) = $2.0(S_p) + 6.0(F)$ = n/a

Rip Rap Splash Pad Dimensions:

L_a = 12 ft
 $W1 = 3.0(S_p)$ min. = 3 ft
 $W2 = 3.0(S_p) + 0.4(L_a)$ min. = 8 ft
d (Depth of Stone) = 12 inches

Outlet Protection Calculations

Project: Wake Robin Inn
Location: Salisbury, CT
Outlet I.D.: **FES 23**

By: MCB Date: 07/19/24
Checked: Date:

*Based on Connecticut DOT Drainage Manual, Section 11.13

Description:

FES 23

Design Criteria (10-yr Storm Event):

Q (cfs) = 1.32 R_p (ft) = 0.666666667
D (in) = 8 S_p (ft) = 0.666666667
V (fps) = 5.76 T_w (ft) = 0.35

Q = Flow rate at discharge point in cubic feet per second (cfs)
D = Outlet pipe diameter (in)
V = Flow velocity at discharge point (ft/s)
 R_p = Maximum inside pipe rise (ft)
 S_p = inside diameter for circular sections of maximum inside pipe span for non-circular sections (ft)
 T_w = Tailwater depth (ft)

Based on **Table 11-13.1** use Type 'B' ----> $TW \geq 0.5 R_p$

Rip Rap Stone Size:

<u>Velocity</u>	<u>Rip Rap Specification</u>	<u>D_{50} Stone Size</u>
0-8 fps	Modified	5 inches

Preformed Scour Hole Dimensions:

F (ft) = $0.5(R_p)$ = n/a
 C (ft) = $3.0(S_p) + 6.0(F)$ = n/a
 B (ft) = $2.0(S_p) + 6.0(F)$ = n/a

Rip Rap Splash Pad Dimensions:

L_a = 10 ft
 $W1 = 3.0(S_p)$ min. = 2 ft
 $W2 = 3.0(S_p) + 0.4(L_a)$ min. = 6 ft
d (Depth of Stone) = 12 inches

Level Spreader Design

Level Spreader 220

Broad Crest Elevation (ft)	801.00
Length (ft)	30
Discharge Coefficient	3.2
Elevation Increment	0.05
Q-100 year (cfs)	6.27 (DET 220 Discharge)

Elevation (Feet)	Weir Discharge (cfs)	Area (sf)	Velocity (fps)
801.00	0.00	0.00	0.00
801.05	1.07	1.50	0.72
801.10	3.04	3.00	1.01
801.15	5.58	4.50	1.24
801.16	6.27	4.86	1.29
801.20	8.59	6.00	1.43
801.25	12.00	7.50	1.60
801.30	15.77	9.00	1.75
801.35	19.88	10.50	1.89
801.40	24.29	12.00	2.02
801.45	28.98	13.50	2.15
801.50	33.94	15.00	2.26

DATE PLOTTED: 08/01/2024 10:00:00 AM
SCALE: 1"=80'
SHEET NO: 1 OF 1
PROJECT NO: 22100.00001
DATE: JULY 19, 2024
DRAWN BY: MCB
CHECKED BY: TDR
DESIGNED BY: MCB

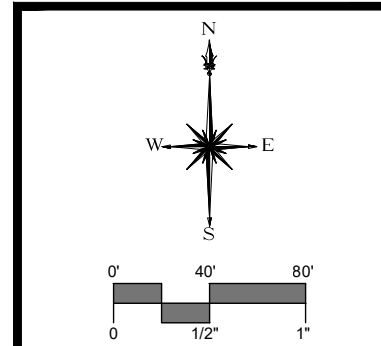

SLR
99 REALTY DRIVE
SUITE 200
SALISBURY, CT 06488
203.271.1773
SLRCONSULTING.COM

DESCRIPTION	DATE	BY
P&Z SUBMISSION	08/01/2024	MCB

DRAINAGE AREA MAP - STORM DRAINAGE SYSTEM
WAKE ROBIN INN REDEVELOPMENT
104 & 106 SHARON ROAD
SALISBURY, CONNECTICUT

MCB	MCB	TDR
DESIGNED	DRAWN	CHECKED

SCALE: 1"=80'
DATE: JULY 19, 2024
PROJECT NO: 22100.00001
SHEET NO: 1 OF 1

CB



Appendix E

Water Quality Computations

Wake Robin Inn Redevelopment

104 & 106 Sharon Road, Salisbury, Connecticut

Drainage Report

Prepared for:
Aradev LLC
352 Atlantic Avenue, Unit 2
Brooklyn, NY 11217

SLR Project No.: 141.22100.00001

July 19, 2024

Revised August 1, 2024



STORMWATER QUALITY CALCULATIONS
Water Quality Volume (WQV)

Basin ID	Total Area (ac.)	Impervious Area (ac.)	Percent Impervious	Volumetric Runoff Coeff., R	WQV (ac-ft)	Total Volume Required (ac-ft)	Total Volume Provided¹⁻ (ac-ft)
120	0.99	0.49	49%	0.50	0.053	0.053	0.053
210	2.22	1.00	45%	0.46	0.110	0.110	0.110
220	1.11	0.58	52%	0.52	0.063	0.063	0.076

1.- Volume provided below low-flow orifice

$$\mathbf{WQV} = \frac{(1.3 \text{ inches}) \times A \times R}{12}$$

Where:

- WQV = Water Quality Volume in acre-feet
- A = Contributing Area in acres
- R = 0.05 + 0.009 (I)
- I = Site Imperviousness as percent

STORMWATER QUALITY CALCULATIONS
Water Quality Volume (WQV)

UG 120

Elevation (ft)	Surface Area (ft²)	Volume (ft³)	Volume (ac-ft)	Cumulative Volume (ac-ft)
816.0	1,920	0.0	0.000	0.000
817.0	1,920	1,920.0	0.044	0.044
817.2	1,920	384.0	0.009	0.053

DET 210

Elevation (ft)	Surface Area (ft²)	Volume (ft³)	Volume (ac-ft)	Cumulative Volume (ac-ft)
815.0	7,516	0.0	0.000	0.000
815.6	8,388	4,771.2	0.110	0.110

DET 220

Elevation (ft)	Surface Area (ft²)	Volume (ft³)	Volume (ac-ft)	Cumulative Volume (ac-ft)
800.0	879	0.0	0.000	0.000
801.0	1,441	1,160.0	0.027	0.027
802.0	2,039	1,740.0	0.040	0.067
802.2	2,165	420.4	0.010	0.076

SLR Consulting		Project	22100.00001
COMPUTATION SHEET - WATER QUALITY FLOW (WQF)		Made By:	MCB
Subject:	Wake Robin Inn	Date:	7/18/2024
		Chkd by:	
		Date:	
CDS Unit - MH 13			
Contributing Basins		Imperv. Area (acres)	Total Area (acres)
Total		0.46	0.97
Table 4.1: $WQV = (P)(R_v)(A)/12 =$			0.050 acre-feet
Where:			
I = % of Impervious Cover =			47%
$R_v =$ volumetric runoff coeff. $0.05 + 0.009(I) =$			0.477
P = design precipitation (1.3" for water quality storm) =			1.3 inch
A = site area (acres) =		0.97 acres =	0.0015 miles ²
Q = runoff depth (in watershed inches) = $[WQV(\text{acre-feet})][12(\text{inches/foot})]/\text{drainage area (acres)}$			
		Q =	0.620
$CN = 1000 / [10 + 5P + 10Q - 10(Q^2 + 1.25QP)^{0.5}] =$			92
Where:			
Q = runoff depth (in watershed inches)			
		$t_c =$	0.1 hours
Type III Rainfall Distribution:			
From Table 4-1, $l_a =$		0.174	$l_a/P = 0.1338$
(TR-55)			
From Exhibit 4-III, $q_u =$		630 csm/in.	
(TR-55)			
$WQF = (q_u)(A)(Q) =$		0.59 cfs	CDS 2015-4-C Flow = 1.4 cfs -> OK



2. Compute the time of concentration (t_c) based on the methods described in Chapter 3 of TR-55. A minimum value of 0.167 hours (10 minutes) should be used. For sheet flow, the flow path should not be longer than 300 feet.
3. Using the computed CN, t_c , and drainage area (A) in acres, compute the peak discharge for the water quality storm (i.e., the water quality flow [WQF]), based on the procedures described in Chapter 4 of TR-55.
 - Read initial abstraction (I_a) from Table 4-1 in Chapter 4 of TR-55 (reproduced below); compute I_a/P

Table 4-1 I_a values for runoff curve numbers

Curve number	I_a (in)	Curve number	I_a (in)	Curve number	I_a (in)	Curve number	I_a (in)
40	3.000	55	1.636	70	0.857	85	0.353
41	2.878	56	1.571	71	0.817	86	0.326
42	2.762	57	1.509	72	0.778	87	0.299
43	2.651	58	1.448	73	0.740	88	0.273
44	2.545	59	1.390	74	0.703	89	0.247
45	2.444	60	1.333	75	0.667	90	0.222
46	2.348	61	1.279	76	0.632	91	0.198
47	2.255	62	1.226	77	0.597	92	0.174
48	2.167	63	1.175	78	0.564	93	0.151
49	2.082	64	1.125	79	0.532	94	0.128
50	2.000	65	1.077	80	0.500	95	0.105
51	1.922	66	1.030	81	0.469	96	0.083
52	1.846	67	0.985	82	0.439	97	0.062
53	1.774	68	0.941	83	0.410	98	0.041
54	1.704	69	0.899	84	0.381		

- Read the unit peak discharge (q_u) from Exhibit 4-III in Chapter 4 of TR-55 (reproduced below) for appropriate t_c

Exhibit 4-III Unit peak discharge (q_u) for NRCS (SCS) type III rainfall distribution

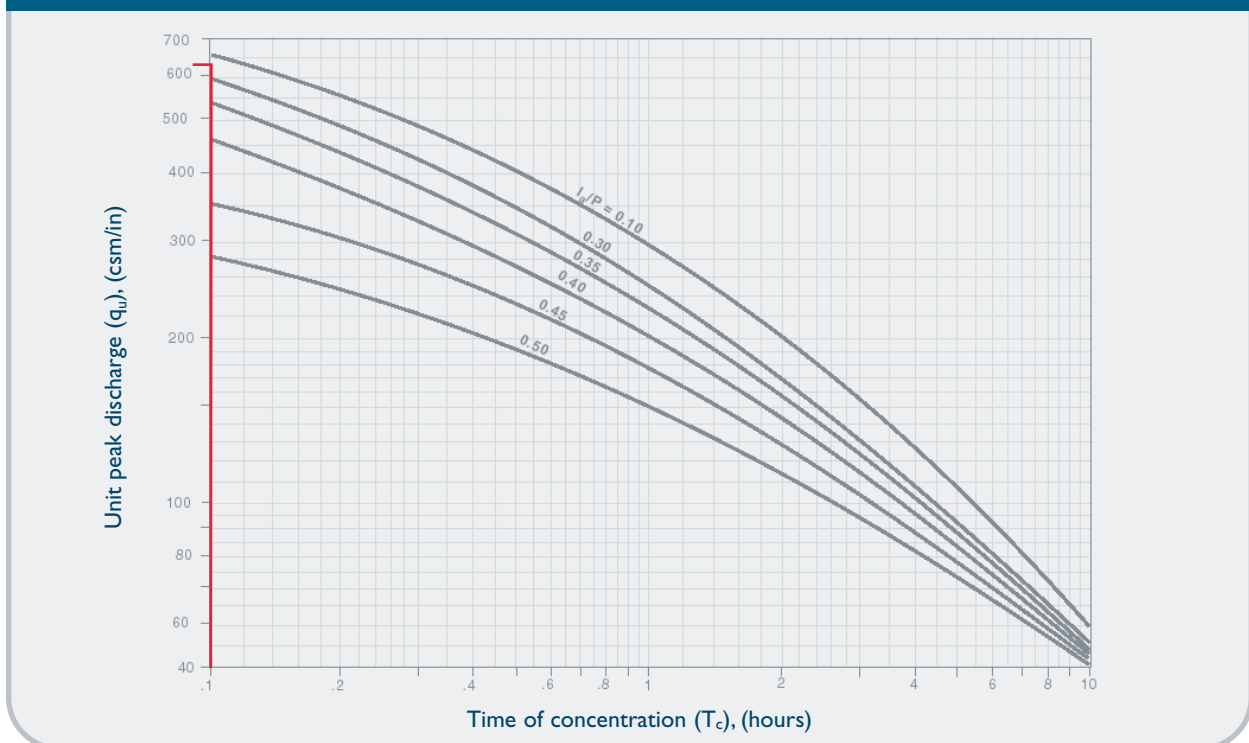

Product Flow Rates

CASCADE

Model	Treatment Rate (cfs)	Sediment Capacity ¹ (CF)
CS-4	2.00	19
CS-5	3.50	29
CS-6	5.60	42
CS-8	12.00	75
CS-10	18.00	118

CDS

Model	Treatment Rate ² (cfs)	Sediment Capacity ¹ (CF)
1515-3	1.00	14
2015-4	1.40	25
2015-5	1.40	39
2015-6	1.40	57
2020-5	2.20	39
2020-6	2.20	57
2025-5	3.20	39
2025-6	3.20	57
3020-6	3.90	57
3025-6	5.00	57
3030-6	5.70	57
3035-6	6.50	57
4030-8	7.50	151
4040-8	9.50	151

VORTECHS

Model	Treatment Rate (cfs)	Sediment Capacity ³ (CF)
1000	1.60	16
2000	2.80	32
3000	4.50	49
4000	6.00	65
5000	8.50	86
7000	11.00	108
9000	14.00	130
11000	17.5	151
16000	25	192

STORMCEPTOR STC

Model	Treatment Rate (cfs)	Sediment Capacity ¹ (CF)
STC 450i	0.40	46
STC 900	0.89	89
STC 2400	1.58	205
STC 4800	2.47	543
STC 7200	3.56	839
STC 11000	4.94	1086
STC 16000	7.12	1677

1 Additional sediment storage capacity available – Check with your local representative for information.

2 Treatment Capacity is based on laboratory testing using OK-110 (average D50 particle size of approximately 100 microns) and a 2400 micron screen.

3 Maintenance recommended when sediment depth has accumulated to within 12-18 inches of the dry weather water surface elevation.



NOTHING IN THIS CATALOG SHOULD BE CONSTRUED AS A WARRANTY. APPLICATIONS SUGGESTED HEREIN ARE DESCRIBED ONLY TO HELP READERS MAKE THEIR OWN EVALUATIONS AND DECISIONS, AND ARE NEITHER GUARANTEES NOR WARRANTIES OF SUITABILITY FOR ANY APPLICATION. CONTECH MAKES NO WARRANTY WHATSOEVER, EXPRESS OR IMPLIED, RELATED TO THE APPLICATIONS, MATERIALS, COATINGS, OR PRODUCTS DISCUSSED HEREIN. ALL IMPLIED WARRANTIES OF MERCHANTABILITY AND ALL IMPLIED WARRANTIES OF FITNESS FOR ANY PARTICULAR PURPOSE ARE DISCLAIMED BY CONTECH. SEE CONTECH'S CONDITIONS OF SALE (AVAILABLE AT WWW.CONTECHES.COM/COS) FOR MORE INFORMATION.



Get social with us: [f](#) [in](#) [t](#) [v](#)

800-338-1122 | www.ContechES.com

CDS2015-4-C DESIGN NOTES

THE STANDARD CDS2015-4-C CONFIGURATION IS SHOWN. ALTERNATE CONFIGURATIONS ARE AVAILABLE AND ARE LISTED BELOW. SOME CONFIGURATIONS MAY BE COMBINED TO SUIT SITE REQUIREMENTS.

CONFIGURATION DESCRIPTION

- GRATED INLET ONLY (NO INLET PIPE)
- GRATED INLET WITH INLET PIPE OR PIPES
- CURB INLET ONLY (NO INLET PIPE)
- CURB INLET WITH INLET PIPE OR PIPES
- SEPARATE OIL BAFFLE (SINGLE INLET PIPE REQUIRED FOR THIS CONFIGURATION)
- SEDIMENT WEIR FOR NJDEP / NJCAT CONFORMING UNITS

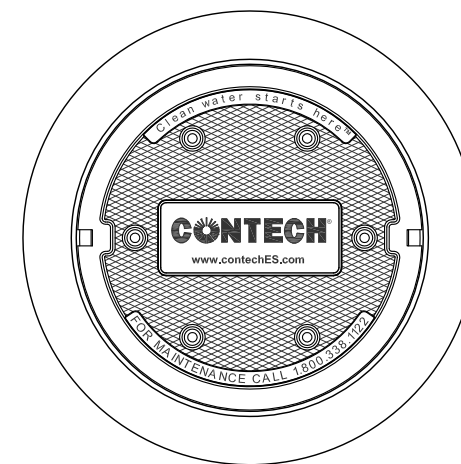
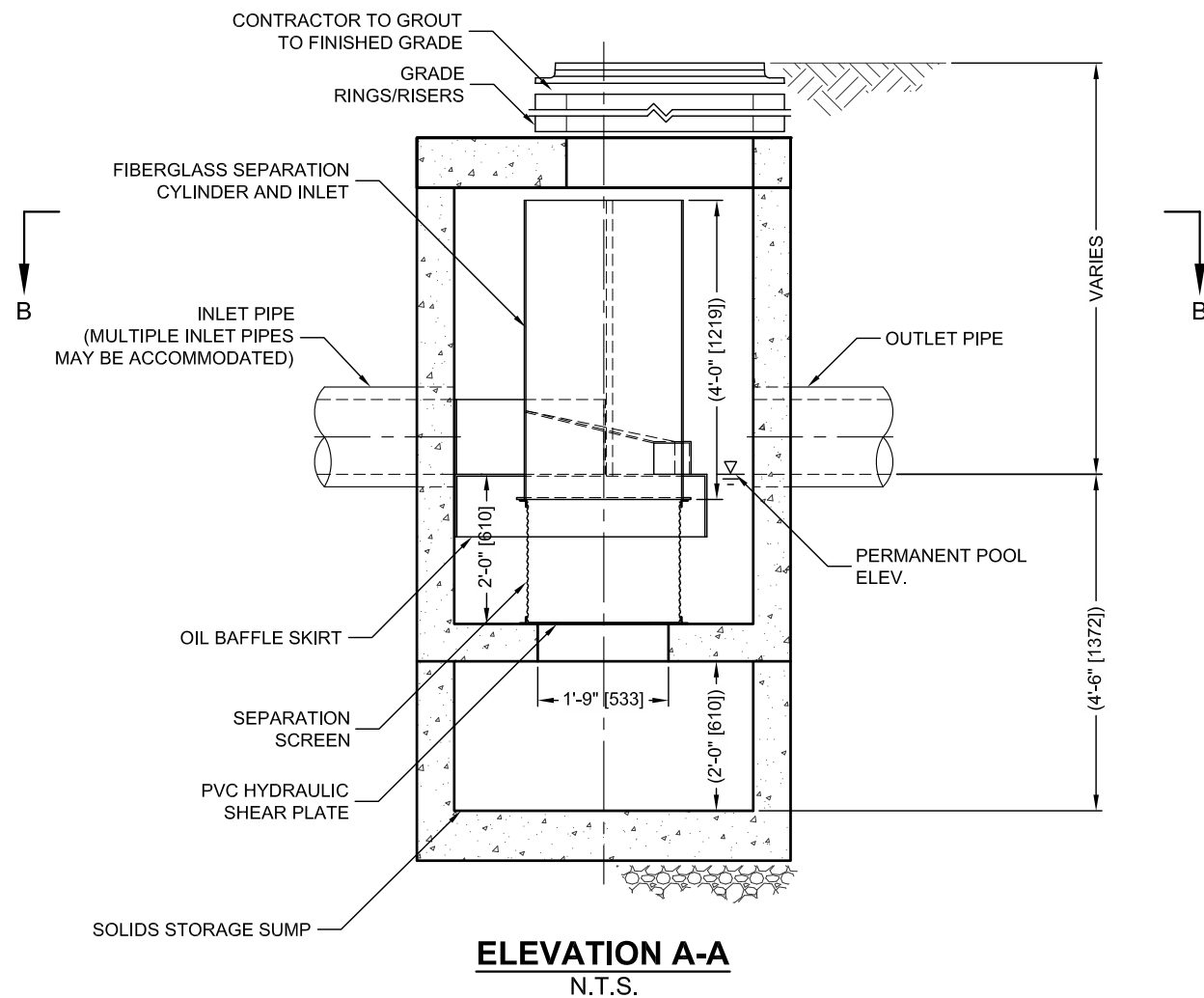
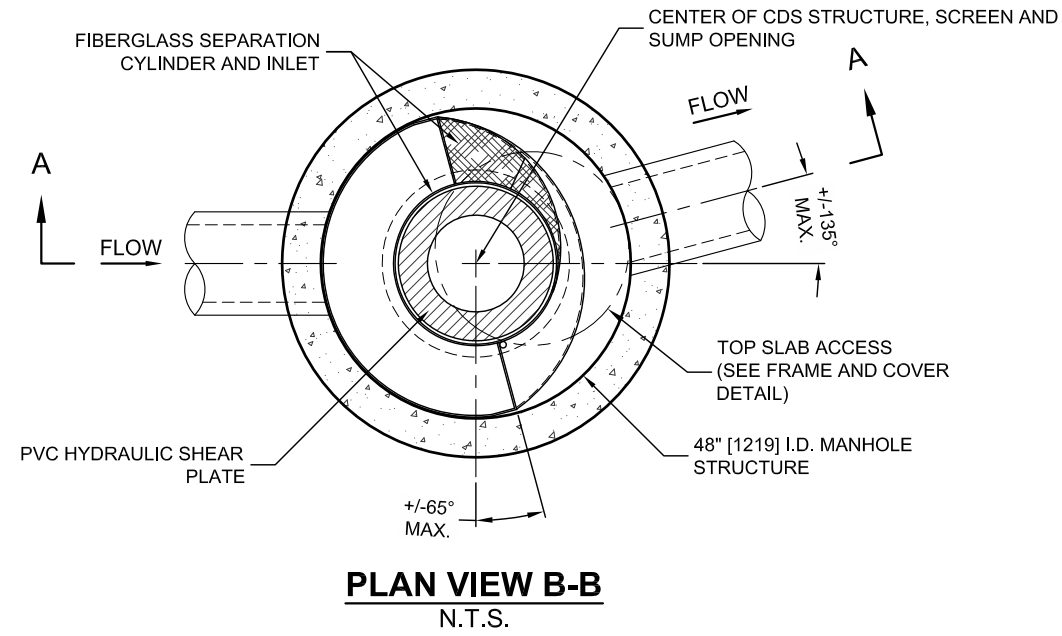

SITE SPECIFIC DATA REQUIREMENTS

STRUCTURE ID				
WATER QUALITY FLOW RATE (CFS OR L/s)				*
PEAK FLOW RATE (CFS OR L/s)				*
RETURN PERIOD OF PEAK FLOW (YRS)				*
SCREEN APERTURE (2400 OR 4700)				*
PIPE DATA:	I.E.	MATERIAL	DIAMETER	
INLET PIPE 1	*	*	*	
INLET PIPE 2	*	*	*	
OUTLET PIPE	*	*	*	
RIM ELEVATION				*
ANTI-FLOTATION BALLAST	*	WIDTH	*	HEIGHT
NOTES/SPECIAL REQUIREMENTS:				
* PER ENGINEER OF RECORD				

GENERAL NOTES

1. CONTECH TO PROVIDE ALL MATERIALS UNLESS NOTED OTHERWISE.
2. DIMENSIONS MARKED WITH () ARE REFERENCE DIMENSIONS. ACTUAL DIMENSIONS MAY VARY.
3. FOR FABRICATION DRAWINGS WITH DETAILED STRUCTURE DIMENSIONS AND WEIGHTS, PLEASE CONTACT YOUR CONTECH ENGINEERED SOLUTIONS LLC REPRESENTATIVE. www.contechES.com
4. CDS WATER QUALITY STRUCTURE SHALL BE IN ACCORDANCE WITH ALL DESIGN DATA AND INFORMATION CONTAINED IN THIS DRAWING.
5. STRUCTURE SHALL MEET AASHTO HS20 AND CASTINGS SHALL MEET HS20 (AASHTO M 306) LOAD RATING, ASSUMING GROUNDWATER ELEVATION AT, OR BELOW, THE OUTLET PIPE INVERT ELEVATION. ENGINEER OF RECORD TO CONFIRM ACTUAL GROUNDWATER ELEVATION.
6. PVC HYDRAULIC SHEAR PLATE IS PLACED ON SHELF AT BOTTOM OF SCREEN CYLINDER. REMOVE AND REPLACE AS NECESSARY DURING MAINTENANCE CLEANING.

INSTALLATION NOTES

- A. ANY SUB-BASE, BACKFILL DEPTH, AND/OR ANTI-FLOTATION PROVISIONS ARE SITE-SPECIFIC DESIGN CONSIDERATIONS AND SHALL BE SPECIFIED BY ENGINEER OF RECORD.
- B. CONTRACTOR TO PROVIDE EQUIPMENT WITH SUFFICIENT LIFTING AND REACH CAPACITY TO LIFT AND SET THE CDS MANHOLE STRUCTURE (LIFTING CLUTCHES PROVIDED).
- C. CONTRACTOR TO ADD JOINT SEALANT BETWEEN ALL STRUCTURE SECTIONS, AND ASSEMBLE STRUCTURE.
- D. CONTRACTOR TO PROVIDE, INSTALL, AND GROUT PIPES. MATCH PIPE INVERTS WITH ELEVATIONS SHOWN.
- E. CONTRACTOR TO TAKE APPROPRIATE MEASURES TO ASSURE UNIT IS WATER TIGHT, HOLDING WATER TO FLOWLINE INVERT MINIMUM. IT IS SUGGESTED THAT ALL JOINTS BELOW PIPE INVERTS ARE GROUTED.

CONTECH
ENGINEERED SOLUTIONS LLC

www.contechES.com
9025 Centre Pointe Dr., Suite 400, West Chester, OH 45069
800-338-1122 513-645-7000 513-645-7993 FAX

CDS2015-4-C
INLINE CDS
STANDARD DETAIL



THIS PRODUCT MAY BE PROTECTED BY ONE OR MORE OF THE FOLLOWING U.S. PATENTS: 6,788,040; 6,841,720; 6,911,585; 6,981,762. RELATED FOREIGN PATENTS, OR OTHER PATENTS PENDING.

CDS Guide

Operation, Design, Performance and Maintenance



CDS®

Using patented continuous deflective separation technology, the CDS system screens, separates and traps debris, sediment, and oil and grease from stormwater runoff. The indirect screening capability of the system allows for 100% removal of floatables and neutrally buoyant material without blinding. Flow and screening controls physically separate captured solids, and minimize the re-suspension and release of previously trapped pollutants. Inline units can treat up to 6 cfs, and internally bypass flows in excess of 50 cfs (1416 L/s). Available precast or cast-in-place, offline units can treat flows from 1 to 300 cfs (28.3 to 8495 L/s). The pollutant removal capacity of the CDS system has been proven in lab and field testing.

Operation Overview

Stormwater enters the diversion chamber where the diversion weir guides the flow into the unit's separation chamber and pollutants are removed from the flow. All flows up to the system's treatment design capacity enter the separation chamber and are treated.

Swirl concentration and screen deflection force floatables and solids to the center of the separation chamber where 100% of floatables and neutrally buoyant debris larger than the screen apertures are trapped.

Stormwater then moves through the separation screen, under the oil baffle and exits the system. The separation screen remains clog free due to continuous deflection.

During the flow events exceeding the treatment design capacity, the diversion weir bypasses excessive flows around the separation chamber, so captured pollutants are retained in the separation cylinder.

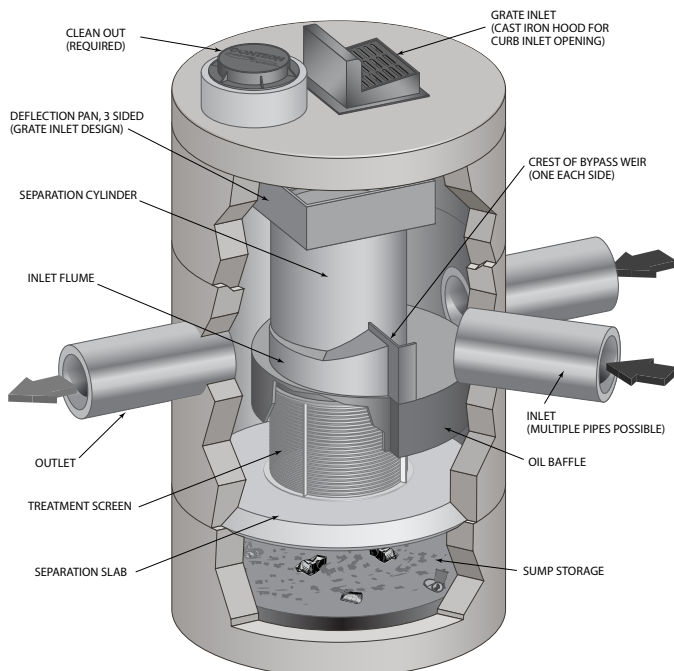

Design Basics

There are three primary methods of sizing a CDS system. The Water Quality Flow Rate Method determines which model size provides the desired removal efficiency at a given flow rate for a defined particle size. The Rational Rainfall Method™ or the Probabilistic Method is used when a specific removal efficiency of the net annual sediment load is required.

Typically in the United States, CDS systems are designed to achieve an 80% annual solids load reduction based on lab generated performance curves for a gradation with an average particle size (d50) of 125 microns (μm). For some regulatory environments, CDS systems can also be designed to achieve an 80% annual solids load reduction based on an average particle size (d50) of 75 microns (μm) or 50 microns (μm).

Water Quality Flow Rate Method

In some cases, regulations require that a specific treatment rate, often referred to as the water quality design flow (WQQ), be treated. This WQQ represents the peak flow rate from either an event with a specific recurrence interval, e.g. the six-month storm, or a water quality depth, e.g. 1/2-inch (13 mm) of rainfall.

The CDS is designed to treat all flows up to the WQQ. At influent rates higher than the WQQ, the diversion weir will direct most flow exceeding the WQQ around the separation chamber. This allows removal efficiency to remain relatively constant in the separation chamber and eliminates the risk of washout during bypass flows regardless of influent flow rates.

Treatment flow rates are defined as the rate at which the CDS will remove a specific gradation of sediment at a specific removal efficiency. Therefore the treatment flow rate is variable, based on the gradation and removal efficiency specified by the design engineer.

Rational Rainfall Method™

Differences in local climate, topography and scale make every site hydraulically unique. It is important to take these factors into consideration when estimating the long-term performance of any stormwater treatment system. The Rational Rainfall Method combines site-specific information with laboratory generated performance data, and local historical precipitation records to estimate removal efficiencies as accurately as possible.

Short duration rain gauge records from across the United States and Canada were analyzed to determine the percent of the total annual rainfall that fell at a range of intensities. US stations' depths were totaled every 15 minutes, or hourly, and recorded in 0.01-inch increments. Depths were recorded hourly with 1-mm resolution at Canadian stations. One trend was consistent at all sites; the vast majority of precipitation fell at low intensities and high intensity storms contributed relatively little to the total annual depth.

These intensities, along with the total drainage area and runoff coefficient for each specific site, are translated into flow rates using the Rational Rainfall Method. Since most sites are relatively small and highly impervious, the Rational Rainfall Method is appropriate. Based on the runoff flow rates calculated for each intensity, operating rates within a proposed CDS system are

determined. Performance efficiency curve determined from full scale laboratory tests on defined sediment PSDs is applied to calculate solids removal efficiency. The relative removal efficiency at each operating rate is added to produce a net annual pollutant removal efficiency estimate.

Probabilistic Rational Method

The Probabilistic Rational Method is a sizing program Contech developed to estimate a net annual sediment load reduction for a particular CDS model based on site size, site runoff coefficient, regional rainfall intensity distribution, and anticipated pollutant characteristics.

The Probabilistic Method is an extension of the Rational Method used to estimate peak discharge rates generated by storm events of varying statistical return frequencies (e.g. 2-year storm event). Under the Rational Method, an adjustment factor is used to adjust the runoff coefficient estimated for the 10-year event, correlating a known hydrologic parameter with the target storm event. The rainfall intensities vary depending on the return frequency of the storm event under consideration. In general, these two frequency dependent parameters (rainfall intensity and runoff coefficient) increase as the return frequency increases while the drainage area remains constant.

These intensities, along with the total drainage area and runoff coefficient for each specific site, are translated into flow rates using the Rational Method. Since most sites are relatively small and highly impervious, the Rational Method is appropriate. Based on the runoff flow rates calculated for each intensity, operating rates within a proposed CDS are determined. Performance efficiency curve on defined sediment PSDs is applied to calculate solids removal efficiency. The relative removal efficiency at each operating rate is added to produce a net annual pollutant removal efficiency estimate.

Treatment Flow Rate

The inlet throat area is sized to ensure that the WQQ passes through the separation chamber at a water surface elevation equal to the crest of the diversion weir. The diversion weir bypasses excessive flows around the separation chamber, thus preventing re-suspension or re-entrainment of previously captured particles.

Hydraulic Capacity

The hydraulic capacity of a CDS system is determined by the length and height of the diversion weir and by the maximum allowable head in the system. Typical configurations allow hydraulic capacities of up to ten times the treatment flow rate. The crest of the diversion weir may be lowered and the inlet throat may be widened to increase the capacity of the system at a given water surface elevation. The unit is designed to meet project specific hydraulic requirements.

Performance

Full-Scale Laboratory Test Results

A full-scale CDS system (Model CDS2020-5B) was tested at the facility of University of Florida, Gainesville, FL. This CDS unit was evaluated under controlled laboratory conditions of influent flow rate and addition of sediment.

Two different gradations of silica sand material (UF Sediment & OK-110) were used in the CDS performance evaluation. The particle size distributions (PSDs) of the test materials were analyzed using standard method "Gradation ASTM D-422 "Standard Test Method for Particle-Size Analysis of Soils" by a certified laboratory.

UF Sediment is a mixture of three different products produced by the U.S. Silica Company: "Sil-Co-Sil 106", "#1 DRY" and "20/40 Oil Frac". Particle size distribution analysis shows that the UF Sediment has a very fine gradation ($d_{50} = 20$ to $30 \mu\text{m}$) covering a wide size range (Coefficient of Uniformity, C averaged at 10.6). In comparison with the hypothetical TSS gradation specified in the NJDEP (New Jersey Department of Environmental Protection) and NJCAT (New Jersey Corporation for Advanced Technology) protocol for lab testing, the UF Sediment covers a similar range of particle size but with a finer d_{50} (d_{50} for NJDEP is approximately $50 \mu\text{m}$) (NJDEP, 2003).

The OK-110 silica sand is a commercial product of U.S. Silica Sand. The particle size distribution analysis of this material, also included in Figure 1, shows that 99.9% of the OK-110 sand is finer than 250 microns, with a mean particle size (d_{50}) of 106 microns. The PSDs for the test material are shown in Figure 1.

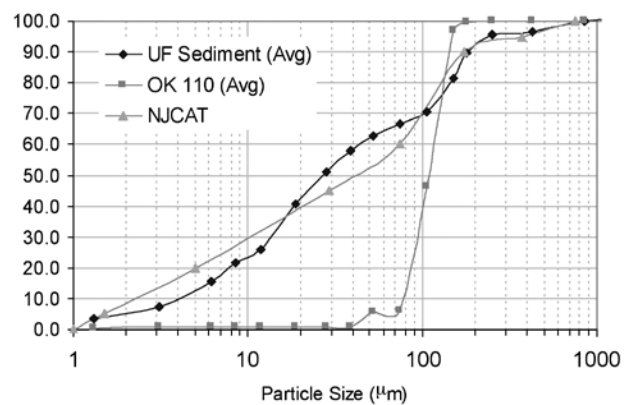

Figure 1. Particle size distributions

Tests were conducted to quantify the performance of a specific CDS unit (1.1 cfs (31.3-L/s) design capacity) at various flow rates, ranging from 1% up to 125% of the treatment design capacity of the unit, using the 2400 micron screen. All tests were conducted with controlled influent concentrations of approximately 200 mg/L. Effluent samples were taken at equal time intervals across the entire duration of each test run. These samples were then processed with a Dekaport Cone sample splitter to obtain representative sub-samples for Suspended Sediment Concentration (SSC) testing using ASTM D3977-97 "Standard Test Methods for Determining Sediment Concentration in Water Samples", and particle size distribution analysis.

Results and Modeling

Based on the data from the University of Florida, a performance model was developed for the CDS system. A regression analysis was used to develop a fitting curve representative of the scattered data points at various design flow rates. This model, which demonstrated good agreement with the laboratory data, can then be used to predict CDS system performance with respect

to SSC removal for any particle size gradation, assuming the particles are inorganic sandy-silt. Figure 2 shows CDS predictive performance for two typical particle size gradations (NJCAT gradation and OK-110 sand) as a function of operating rate.

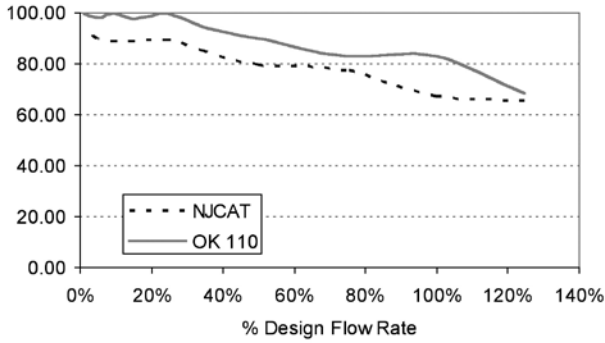

Figure 2. CDS stormwater treatment predictive performance for various particle gradations as a function of operating rate.

Many regulatory jurisdictions set a performance standard for hydrodynamic devices by stating that the devices shall be capable of achieving an 80% removal efficiency for particles having a mean particle size (d_{50}) of 125 microns (e.g. Washington State Department of Ecology — WASDOE - 2008). The model can be used to calculate the expected performance of such a PSD (shown in Figure 3). The model indicates (Figure 4) that the CDS system with 2400 micron screen achieves approximately 80% removal at the design (100%) flow rate, for this particle size distribution ($d_{50} = 125 \mu\text{m}$).

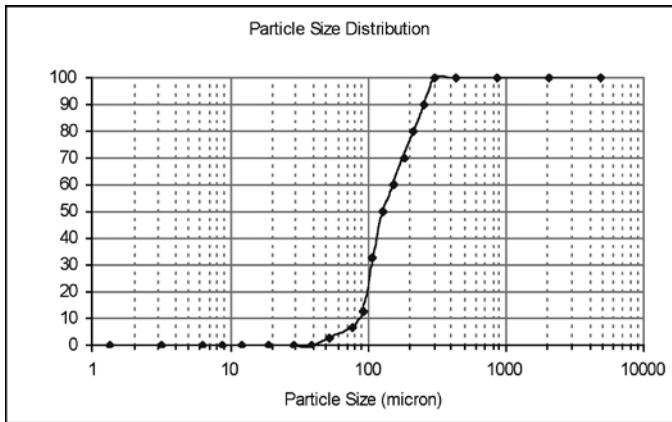

Figure 3. WASDOE PSD

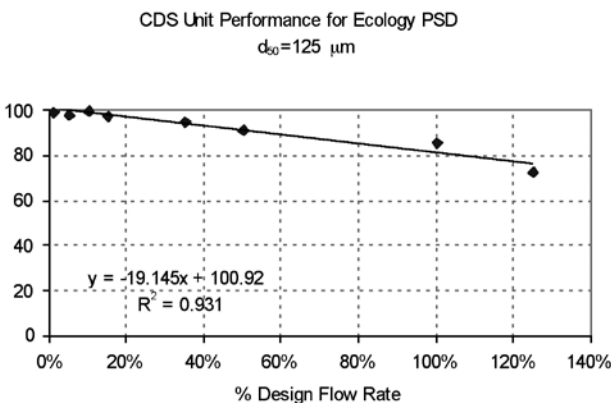

Figure 4. Modeled performance for WASDOE PSD.

Maintenance

The CDS system should be inspected at regular intervals and maintained when necessary to ensure optimum performance. The rate at which the system collects pollutants will depend more heavily on site activities than the size of the unit. For example, unstable soils or heavy winter sanding will cause the grit chamber to fill more quickly but regular sweeping of paved surfaces will slow accumulation.

Inspection

Inspection is the key to effective maintenance and is easily performed. Pollutant transport and deposition may vary from year to year and regular inspections will help ensure that the system is cleaned out at the appropriate time. At a minimum, inspections should be performed twice per year (e.g. spring and fall) however more frequent inspections may be necessary in climates where winter sanding operations may lead to rapid accumulations, or in equipment washdown areas. Installations should also be inspected more frequently where excessive amounts of trash are expected.

The visual inspection should ascertain that the system components are in working order and that there are no blockages or obstructions in the inlet and separation screen. The inspection should also quantify the accumulation of hydrocarbons, trash, and sediment in the system. Measuring pollutant accumulation can be done with a calibrated dipstick, tape measure or other measuring instrument. If absorbent material is used for enhanced removal of hydrocarbons, the level of discoloration of the sorbent material should also be identified



during inspection. It is useful and often required as part of an operating permit to keep a record of each inspection. A simple form for doing so is provided.

Access to the CDS unit is typically achieved through two manhole access covers. One opening allows for inspection and cleanout of the separation chamber (cylinder and screen) and isolated sump. The other allows for inspection and cleanout of sediment captured and retained outside the screen. For deep units, a single manhole access point would allow both sump cleanout and access outside the screen.

The CDS system should be cleaned when the level of sediment has reached 75% of capacity in the isolated sump or when an appreciable level of hydrocarbons and trash has accumulated. If absorbent material is used, it should be replaced when significant discoloration has occurred. Performance will not be impacted until 100% of the sump capacity is exceeded however it is recommended that the system be cleaned prior to that for easier removal of sediment. The level of sediment is easily determined by measuring from finished grade down to the top of the sediment pile. To avoid underestimating the level of sediment in the chamber, the measuring device must be lowered to the top of the sediment pile carefully. Particles at the top of the pile typically offer less resistance to the end of the rod than consolidated particles toward the bottom of the pile. Once this measurement is recorded, it should be compared to the as-built drawing for the unit to determine whether the height of the sediment pile off the bottom of the sump floor exceeds 75% of the total height of isolated sump.

Cleaning

Cleaning of a CDS system should be done during dry weather conditions when no flow is entering the system. The use of a vacuum truck is generally the most effective and convenient method of removing pollutants from the system. Simply remove the manhole covers and insert the vacuum hose into the sump. The system should be completely drained down and the sump fully evacuated of sediment. The area outside the screen should also be cleaned out if pollutant build-up exists in this area.

In installations where the risk of petroleum spills is small, liquid contaminants may not accumulate as quickly as sediment. However, the system should be cleaned out immediately in the event of an oil or gasoline spill. Motor oil and other hydrocarbons that accumulate on a more routine basis should be removed when an appreciable layer has been captured. To remove these pollutants, it may be preferable to use absorbent pads since they are usually less expensive to dispose than the oil/water emulsion that may be created by vacuuming the oily layer. Trash and debris can be netted out to separate it from the other pollutants. The screen should be cleaned to ensure it is free of trash and debris.

Manhole covers should be securely seated following cleaning activities to prevent leakage of runoff into the system from above and also to ensure that proper safety precautions have been followed. Confined space entry procedures need to be followed if physical access is required. Disposal of all material removed from the CDS system should be done in accordance with local regulations. In many jurisdictions, disposal of the sediments may be handled in the same manner as the disposal of sediments removed from catch basins or deep sump manholes. Check your local regulations for specific requirements on disposal.



CDS Model	Diameter		Distance from Water Surface to Top of Sediment Pile		Sediment Storage Capacity	
	ft	m	ft	m	y ³	m ³
CDS1515	3	0.9	3.0	0.9	0.5	0.4
CDS2015	4	1.2	3.0	0.9	0.9	0.7
CDS2015	5	1.5	3.0	0.9	1.3	1.0
CDS2020	5	1.5	3.5	1.1	1.3	1.0
CDS2025	5	1.5	4.0	1.2	1.3	1.0
CDS3020	6	1.8	4.0	1.2	2.1	1.6
CDS3025	6	1.8	4.0	1.2	2.1	1.6
CDS3030	6	1.8	4.6	1.4	2.1	1.6
CDS3035	6	1.8	5.0	1.5	2.1	1.6
CDS4030	8	2.4	4.6	1.4	5.6	4.3
CDS4040	8	2.4	5.7	1.7	5.6	4.3
CDS4045	8	2.4	6.2	1.9	5.6	4.3
CDS5640	10	3.0	6.3	1.9	8.7	6.7
CDS5653	10	3.0	7.7	2.3	8.7	6.7
CDS5668	10	3.0	9.3	2.8	8.7	6.7
CDS5678	10	3.0	10.3	3.1	8.7	6.7

Table 1: CDS Maintenance Indicators and Sediment Storage Capacities

Note: To avoid underestimating the volume of sediment in the chamber, carefully lower the measuring device to the top of the sediment pile. Finer silty particles at the top of the pile may be more difficult to feel with a measuring stick. These finer particles typically offer less resistance to the end of the rod than larger particles toward the bottom of the pile.



CDS Inspection & Maintenance Log

CDS Model: _____ Location: _____

Date	Water depth to sediment ¹	Floatable Layer Thickness ²	Describe Maintenance Performed	Maintenance Personnel	Comments

1. The water depth to sediment is determined by taking two measurements with a stadia rod: one measurement from the manhole opening to the top of the sediment pile and the other from the manhole opening to the water surface. If the difference between these measurements is less than the values listed in table 1 the system should be cleaned out. **Note: to avoid underestimating the volume of sediment in the chamber, the measuring device must be carefully lowered to the top of the sediment pile.**
2. For optimum performance, the system should be cleaned out when the floating hydrocarbon layer accumulates to an appreciable thickness. In the event of an oil spill, the system should be cleaned immediately.

SUPPORT

- Drawings and specifications are available at www.ContechES.com.
- Site-specific design support is available from our engineers.



800-338-1122

www.ContechES.com

©2017 Contech Engineered Solutions LLC, a QUIKRETE Company

Contech Engineered Solutions provides site solutions for the civil engineering industry. Contech's portfolio includes bridges, drainage, sanitary sewer, earth stabilization and stormwater treatment products. For information on other Contech division offerings, visit www.ContechES.com or call 800.338.1122

NOTHING IN THIS CATALOG SHOULD BE CONSTRUED AS A WARRANTY. APPLICATIONS SUGGESTED HEREIN ARE DESCRIBED ONLY TO HELP READERS MAKE THEIR OWN EVALUATIONS AND DECISIONS, AND ARE NEITHER GUARANTEES NOR WARRANTIES OF SUITABILITY FOR ANY APPLICATION. CONTECH MAKES NO WARRANTY WHATSOEVER, EXPRESS OR IMPLIED, RELATED TO THE APPLICATIONS, MATERIALS, COATINGS, OR PRODUCTS DISCUSSED HEREIN. ALL IMPLIED WARRANTIES OF MERCHANTABILITY AND ALL IMPLIED WARRANTIES OF FITNESS FOR ANY PARTICULAR PURPOSE ARE DISCLAIMED BY CONTECH. SEE CONTECH'S CONDITIONS OF SALE (AVAILABLE AT WWW.CONTECHES.COM/COS) FOR MORE INFORMATION.

The product(s) described may be protected by one or more of the following US patents: 5,322,629; 5,624,576; 5,707,527; 5,759,415; 5,788,848; 5,985,157; 6,027,639; 6,350,374; 6,406,218; 6,641,720; 6,511,595; 6,649,048; 6,991,114; 6,998,038; 7,186,058; 7,296,692; 7,297,266; related foreign patents or other patents pending.



Appendix F

Hydrologic Analysis-Input Computations

Wake Robin Inn Redevelopment

104 & 106 Sharon Road, Salisbury, Connecticut

Drainage Report

Prepared for:
Aradev LLC
352 Atlantic Avenue, Unit 2
Brooklyn, NY 11217

SLR Project No.: 141.22100.00001

July 19, 2024

Revised August 1, 2024



Curve Number Calculations

Project: Wake Robin Inn Redevelopment
 Location: 104 & 106 Sharon Road
Salisbury, CT

By: MCB Date: 7/19/24 Checked: _____ Date: _____
 Circle one: **Present** Developed Watershed: _____

Soil Name and Hydrologic Group (appendix A)	Cover Description (cover type, treatment, and hydrologic condition; percent impervious; unconnected/connected impervious area ratio)	CN Value ^{1.}			Area <u>Acres</u> Sq. Ft. %	Product of CN x Area
		Table 2-2	Figure 2-3	Figure 2-4		
B Soil	Woods - Good Condition	55			0.11	5.86
B Soil	Gravel	85			0.01	0.66
D Soil	Woods - Good Condition	77			2.29	176.68
D Soil	Open Space - Good Condition	80			0.01	0.83
N/A	Existing Building	98			0.04	3.59
Totals =					2.46	187.63

(0.00384 sq mi)

CN (weighted) = $\frac{\text{total product}}{\text{total area}}$ = $\frac{187.63}{2.46}$ Use CN = 76



Curve Number Calculations

Project: Wake Robin Inn Redevelopment
 Location: 104 & 106 Sharon Road
Salisbury, CT

By: MCB Date: 7/19/24 Checked: _____ Date: _____
 Circle one: **Present** Developed Watershed: _____

Soil Name and Hydrologic Group (appendix A)	Cover Description (cover type, treatment, and hydrologic condition; percent impervious; unconnected/connected impervious area ratio)	CN Value ¹ .			Area Acres Sq. Ft. %	Product of CN x Area
		Table 2-2	Figure 2-3	Figure 2-4		
B Soil	Woods - Good Condition	55			2.80	154.20
B Soil	Open Space - Good Condition	61			0.94	57.07
B Soil	Gravel	85			0.34	28.97
C Soil	Woods - Good Condition	70			1.52	106.74
D Soil	Woods - Good Condition	77			9.40	723.63
D Soil	Open Space - Good Condition	80			0.73	58.06
D Soil	Gravel	91			0.06	5.49
N/A	Paved/Impervious	98			0.08	7.44
N/A	Existing Building	98			0.19	18.46
Totals =					16.05	1160.06

(0.02508 sq mi)

$$\text{CN (weighted)} = \frac{\text{total product}}{\text{total area}} = \frac{1160.06}{16.05} \quad \text{Use CN} = \boxed{72}$$



Curve Number Calculations

Project: Wake Robin Inn Redevelopment
 Location: 104 & 106 Sharon Road
Salisbury, CT

By: MCB Date: 7/19/24 Checked: _____ Date: _____
 Circle one: Present Developed Watershed: _____

Soil Name and Hydrologic Group (appendix A)	Cover Description (cover type, treatment, and hydrologic condition; percent impervious; unconnected/connected impervious area ratio)	CN Value ^{1.}			Area <u>Acres</u> Sq. Ft. %	Product of CN x Area
		Table 2-2	Figure 2-3	Figure 2-4		
D Soil	Woods - Good Condition	77			3.39	261.35
D Soil	Open Space - Good Condition	80			0.51	40.91
D Soil	Gravel	91			0.38	34.87
N/A	Paved/Impervious	98			0.31	30.81
N/A	Existing Building	98			0.39	38.48
Totals =					5.00	406.41

(0.00781 sq mi)

CN (weighted) = $\frac{\text{total product}}{\text{total area}}$ = $\frac{406.41}{5.00}$ Use CN = 81



Curve Number Calculations

Project: Wake Robin Inn Redevelopment

Location: 104 & 106 Sharon Road

Salisbury, CT

By: MCB Date: 7/19/24 Checked: _____

Date: _____

Circle one: Present Developed Watershed: _____

Soil Name and Hydrologic Group (appendix A)	Cover Description (cover type, treatment, and hydrologic condition; percent impervious; unconnected/connected impervious area ratio)	CN Value ^{1.}			Area <u>Acres</u> Sq. Ft. %	Product of CN x Area
		Table 2-2	Figure 2-3	Figure 2-4		
D Soil	Woods - Good Condition	77			1.66	127.98
N/A	Existing Building	98			0.01	1.00
Totals =					1.67	128.98

(0.00261 sq mi)

CN (weighted) = $\frac{\text{total product}}{\text{total area}}$ = $\frac{128.98}{1.67}$ Use CN = 77



Curve Number Calculations

Project: Wake Robin Inn Redevelopment
 Location: 104 & 106 Sharon Road
Salisbury, CT

By: MCB Date: 7/19/24 Checked: _____ Date: _____
 Circle one: Present **Developed** Watershed: PRWS-10

Soil Name and Hydrologic Group (appendix A)	Cover Description (cover type, treatment, and hydrologic condition; percent impervious; unconnected/connected impervious area ratio)	CN Value ^{1.}			Area <u>Acres</u> Sq. Ft. %	Product of CN x Area
		Table 2-2	Figure 2-3	Figure 2-4		
B Soil	Open Space - Good Condition	61			0.04	2.55
B Soil	Gravel	85			0.003	0.25
D Soil	Woods - Good Condition	77			0.05	4.02
D Soil	Open Space - Good Condition	80			1.01	81.01
D Soil	Gravel	91			0.02	1.79
N/A	Paved/Impervious	98			0.02	1.75
N/A	Building	98			0.02	1.56
Totals =					1.16	92.93
					(0.00182	sq mi)

$$\text{CN (weighted)} = \frac{\text{total product}}{\text{total area}} = \frac{92.93}{1.16} \quad \text{Use CN} = \boxed{80}$$

Curve Number Calculations

Project: Wake Robin Inn Redevelopment
 Location: 104 & 106 Sharon Road
Salisbury, CT

By: MCB Date: 7/19/24 Checked: _____ Date: _____
 Circle one: Present **Developed** Watershed: PRWS-11

Soil Name and Hydrologic Group (appendix A)	Cover Description (cover type, treatment, and hydrologic condition; percent impervious; unconnected/connected impervious area ratio)	CN Value ^{1.}			Area <u>Acres</u> Sq. Ft. %	Product of CN x Area
		Table 2-2	Figure 2-3	Figure 2-4		
B Soil	Woods - Good Condition	55			2.31	127.20
B Soil	Open Space - Good Condition	61			1.27	77.58
B Soil	Gravel	85			0.03	2.74
C Soil	Woods - Good Condition	70			1.52	106.74
D Soil	Woods - Good Condition	77			7.67	590.82
D Soil	Open Space - Good Condition	80			1.81	144.98
D Soil	Gravel	91			0.14	12.48
N/A	Paved/Impervious	98			0.21	20.44
N/A	Building	98			0.46	44.92

Totals = 15.43 1127.89
 (0.02411 sq mi)

CN (weighted) = $\frac{\text{total product}}{\text{total area}}$ = $\frac{1127.89}{15.43}$ Use CN = 73

Curve Number Calculations

Project: Wake Robin Inn Redevelopment
 Location: 104 & 106 Sharon Road
Salisbury, CT

By: MCB Date: 7/19/24 Checked: _____ Date: _____
 Circle one: Present **Developed** Watershed: PRWS-12

Soil Name and Hydrologic Group (appendix A)	Cover Description (cover type, treatment, and hydrologic condition; percent impervious; unconnected/connected impervious area ratio)	CN Value ^{1.}			Area <u>Acres</u> Sq. Ft. %	Product of CN x Area
		Table 2-2	Figure 2-3	Figure 2-4		
B Soil	Open Space - Good Condition	61			0.13	7.76
B Soil	Gravel	85			0.08	6.53
D Soil	Woods - Good Condition	77			0.03	2.16
D Soil	Open Space - Good Condition	80			0.26	20.99
D Soil	Gravel	91			0.05	4.40
N/A	Paved/Impervious	98			0.34	33.65
N/A	Building	98			0.10	9.71
Totals =					0.99	85.21
					(0.00154	sq mi)

$$\text{CN (weighted)} = \frac{\text{total product}}{\text{total area}} = \frac{85.21}{0.99} \quad \text{Use CN} = \boxed{86}$$



Curve Number Calculations

Project: Wake Robin Inn Redevelopment
 Location: 104 & 106 Sharon Road
Salisbury, CT

By: MCB Date: 7/19/24 Checked: _____ Date: _____
 Circle one: Present **Developed** Watershed: PRWS-20

Soil Name and Hydrologic Group (appendix A)	Cover Description (cover type, treatment, and hydrologic condition; percent impervious; unconnected/connected impervious area ratio)	CN Value ^{1.}			Area <u>Acres</u> Sq. Ft. %	Product of CN x Area
		Table 2-2	Figure 2-3	Figure 2-4		
D Soil	Woods - Good Condition	77			0.79	61.14
D Soil	Open Space - Good Condition	80			1.58	126.62
D Soil	Gravel	91			0.13	11.59
N/A	Paved/Impervious	98			0.33	32.19
N/A	Building	98			0.12	11.30
Totals =					2.95	242.84
					(0.00461	sq mi)

$$\text{CN (weighted)} = \frac{\text{total product}}{\text{total area}} = \frac{242.84}{2.95} \quad \text{Use CN} = \boxed{82}$$



Curve Number Calculations

Project: Wake Robin Inn Redevelopment
 Location: 104 & 106 Sharon Road
Salisbury, CT

By: MCB Date: 7/19/24 Checked: _____ Date: _____
 Circle one: Present **Developed** Watershed: PRWS-21

Soil Name and Hydrologic Group (appendix A)	Cover Description (cover type, treatment, and hydrologic condition; percent impervious; unconnected/connected impervious area ratio)	CN Value ^{1.}			Area <u>Acres</u> Sq. Ft. %	Product of CN x Area
		Table 2-2	Figure 2-3	Figure 2-4		
D Soil	Woods - Good Condition	77			0.05	3.78
D Soil	Open Space - Good Condition	80			1.16	92.98
D Soil	Gravel	91			0.14	13.15
N/A	Paved/Impervious	98			0.38	37.10
N/A	Building	98			0.48	47.17
Totals =					2.22	194.18
					(0.00346	sq mi)

CN (weighted) = $\frac{\text{total product}}{\text{total area}}$ = $\frac{194.18}{2.22}$ Use CN = 88



Curve Number Calculations

Project: Wake Robin Inn Redevelopment
 Location: 104 & 106 Sharon Road
Salisbury, CT

By: MCB Date: 7/19/24 Checked: _____ Date: _____
 Circle one: Present **Developed** Watershed: PRWS-22

Soil Name and Hydrologic Group (appendix A)	Cover Description (cover type, treatment, and hydrologic condition; percent impervious; unconnected/connected impervious area ratio)	CN Value ^{1.}			Area <u>Acres</u> Sq. Ft. %	Product of CN x Area
		Table 2-2	Figure 2-3	Figure 2-4		
D Soil	Woods - Good Condition	77			0.004	0.29
D Soil	Open Space - Good Condition	80			0.52	41.81
D Soil	Gravel	91			0.26	23.95
N/A	Paved/Impervious	98			0.30	29.45
N/A	Building	98			0.02	1.94
Totals =					1.11	97.44
					(0.00173	sq mi)

CN (weighted) = $\frac{\text{total product}}{\text{total area}}$ = $\frac{97.44}{1.11}$ Use CN = 88



Curve Number Calculations

Project: Wake Robin Inn Redevelopment
 Location: 104 & 106 Sharon Road
Salisbury, CT

By: MCB Date: 7/19/24 Checked: _____ Date: _____
 Circle one: Present **Developed** Watershed: PRWS-30

Soil Name and Hydrologic Group (appendix A)	Cover Description (cover type, treatment, and hydrologic condition; percent impervious; unconnected/connected impervious area ratio)	CN Value ^{1.}			Area <u>Acres</u> Sq. Ft. %	Product of CN x Area
		Table 2-2	Figure 2-3	Figure 2-4		
D Soil	Woods - Good Condition	77			0.81	62.55
D Soil	Open Space - Good Condition	80			0.40	31.72
D Soil	Gravel	91			0.07	6.41
N/A	Paved/Impervious	98			0.04	3.53
Totals =					1.32	104.20
					(0.00206	sq mi)

CN (weighted) = $\frac{\text{total product}}{\text{total area}}$ = $\frac{104.20}{1.32}$ Use CN = 79



Time of Concentration (T_c) or Travel Time (T_t) Worksheet

Project: Wake Robin Inn Redevelopment By: MCB Date: 07/19/24
 Location: Salisbury, CT Checked: _____ Date: _____
 Circle one: Present Developed Watershed: EXWS-10
 Circle one: T_c T_t Subwatershed: _____

Sheet flow (applicable to T_c only)

	Segment ID	A-B
1. Surface description (Table 3-1)		WOODS
2. Manning's roughness coeff. for sheet flow, n (Table 3-1)		0.400
3. Flow Length, L (< 300ft)	ft.	100.0
4. Two-year 24-hr rainfall, P_2	in.	3.08
5. Land slope, s	ft./ft.	0.070
6. $T_t = \frac{0.007 (nL)^{0.8}}{P_2^{0.5} (s^{0.4})}$	hr.	0.221 = 0.221

Shallow concentrated flow (assume hyd. radius = depth of flow)

	Segment ID	B-C			
7. Surface description		WOODS			
8. Manning's roughness coeff., n		0.100			
9. Paved or unpaved		UNPVD			
10. Depth of flow, d (default values: d=.4 unpaved, d=.2 paved)	ft.	0.40			
11. Flow Length, L	ft.	108.0			
12. Watercourse slope, s	ft./ft.	0.056			
13. Average velocity, $V = \frac{1.49}{n} (d^{2/3})(s^{1/2})$	fps.	1.91			
14. $T_t = \frac{L}{3600 * V}$	hr.	0.016			= 0.016

Channel flow

	Segment ID				
15. Channel Bottom width, b	ft.				
16. Horizontal side slope component, z (z horiz:1 vert)	ft.				
17. Depth of flow, d	ft.				
18. Cross sectional flow area, A (assume trapazoidal)	ft. ²				
19. Wetted perimeter, P_w	ft.				
20. Hydraulic Radius, $R = \frac{A}{P_w}$	ft.				
21. Channel slope, s	ft./ft.				
22. Manning's roughness coeff., n					
23. $V = \frac{1.49}{n} (R^{2/3})(s^{1/2})$	fps.				
24. Flow length, L	ft.				
25. $T_t = \frac{L}{3600 * V}$	hr.				= 0.000
26. Watershed or subarea T_c or T_t (add T_t in steps 6, 14 & 25)	hr.				0.237

Time of Concentration (T_c) or Travel Time (T_t) Worksheet

Project: Wake Robin Inn Redevelopment By: MCB Date: 07/19/24
 Location: Salisbury, CT Checked: _____ Date: _____
 Circle one: Present Developed Watershed: EXWS-11
 Circle one: T_c T_t Subwatershed: _____

Sheet flow (applicable to T_c only)

	Segment ID	A-B			
1. Surface description (Table 3-1)		WOODS			
2. Manning's roughness coeff. for sheet flow, n (Table 3-1)		0.400			
3. Flow Length, L (< 300ft)	ft.	100.0			
4. Two-year 24-hr rainfall, P_2	in.	3.08			
5. Land slope, s	ft./ft.	0.035			
6. $T_t = \frac{0.007 (nL)^{0.8}}{P_2^{0.5} (s^{0.4})}$	hr.	0.292	=		0.292

Shallow concentrated flow (assume hyd. radius = depth of flow)

	Segment ID	B-C			
7. Surface description		WOODS			
8. Manning's roughness coeff., n		0.100			
9. Paved or unpaved		UNPVD			
10. Depth of flow, d (default values: d=.4 unpaved, d=.2 paved)	ft.	0.40			
11. Flow Length, L	ft.	1176.0			
12. Watercourse slope, s	ft./ft.	0.013			
13. Average velocity, $V = \frac{1.49}{n} (d^{2/3})(s^{1/2})$	fps.	0.92			
14. $T_t = \frac{L}{3600 * V}$	hr.	0.354	=		0.354

Channel flow

	Segment ID	C-D	D-E		
15. Channel Bottom width, b	ft.	12" RCP	6.00		
16. Horizontal side slope component, z (z horiz:1 vert)	ft.	--	4.00		
17. Depth of flow, d	ft.	FULL	1.00		
18. Cross sectional flow area, A (assume trapazoidal)	ft. ²	0.79	10.00		
19. Wetted perimeter, P_w	ft.	3.14	14.25		
20. Hydraulic Radius, $R = \frac{A}{P_w}$	ft.	0.25	0.70		
21. Channel slope, s	ft./ft.	0.006	0.057		
22. Manning's roughness coeff., n		0.013	0.024		
23. $V = \frac{1.49}{n} (R^{2/3})(s^{1/2})$	fps.	3.54	11.71		
24. Flow length, L	ft.	31.0	514.0		
25. $T_t = \frac{L}{3600 * V}$	hr.	0.002	0.012	+	
26. Watershed or subarea T_c or T_t (add T_t in steps 6, 14 & 25)	hr.			=	0.015
					0.660

Time of Concentration (T_c) or Travel Time (T_t) Worksheet

Project: Wake Robin Inn Redevelopment By: MCB Date: 07/19/24
 Location: Salisbury, CT Checked: _____ Date: _____
 Circle one: Present Developed Watershed: EXWS-20
 Circle one: T_c T_t Subwatershed: _____

Sheet flow (applicable to T_c only)

	Segment ID	A-B
1. Surface description (Table 3-1)		WOODS
2. Manning's roughness coeff. for sheet flow, n (Table 3-1)		0.400
3. Flow Length, L (< 300ft)	ft.	100.0
4. Two-year 24-hr rainfall, P_2	in.	3.08
5. Land slope, s	ft./ft.	0.060
6. $T_t = \frac{0.007 (nL)^{0.8}}{P_2^{0.5} (s^{0.4})}$	hr.	0.235 = 0.235

Shallow concentrated flow (assume hyd. radius = depth of flow)

	Segment ID	B-C	C-D	D-E	
7. Surface description		WOODS	BIT	WOODS	
8. Manning's roughness coeff., n		0.100	0.010	0.100	
9. Paved or unpaved		UNPVD	PVD	UNPVD	
10. Depth of flow, d (default values: d=.4 unpaved, d=.2 paved)	ft.	0.40	0.20	0.40	
11. Flow Length, L	ft.	40.0	159.0	52.0	
12. Watercourse slope, s	ft./ft.	0.100	0.107	0.096	
13. Average velocity, $V = \frac{1.49}{n} (d^{2/3})(s^{1/2})$	fps.	2.56	16.67	2.51	
14. $T_t = \frac{L}{3600 * V}$	hr.	0.004 +	0.003 +	0.006	= 0.013

Channel flow

	Segment ID				
15. Channel Bottom width, b	ft.				
16. Horizontal side slope component, z (z horiz:1 vert)	ft.				
17. Depth of flow, d	ft.				
18. Cross sectional flow area, A (assume trapazoidal)	ft. ²				
19. Wetted perimeter, P_w	ft.				
20. Hydraulic Radius, $R = \frac{A}{P_w}$	ft.				
21. Channel slope, s	ft./ft.				
22. Manning's roughness coeff., n					
23. $V = \frac{1.49}{n} (R^{2/3})(s^{1/2})$	fps.				
24. Flow length, L	ft.				
25. $T_t = \frac{L}{3600 * V}$	hr.				= 0.000
26. Watershed or subarea T_c or T_t (add T_t in steps 6, 14 & 25)	hr.				0.248

Time of Concentration (T_c) or Travel Time (T_t) Worksheet

Project: Wake Robin Inn Redevelopment By: MCB Date: 07/19/24
 Location: Salisbury, CT Checked: _____ Date: _____
 Circle one: Present Developed Watershed: EXWS-30
 Circle one: T_c T_t Subwatershed: _____

Sheet flow (applicable to T_c only)

	Segment ID	A-B
1. Surface description (Table 3-1)		WOODS
2. Manning's roughness coeff. for sheet flow, n (Table 3-1)		0.400
3. Flow Length, L (< 300ft)	ft.	114.0
4. Two-year 24-hr rainfall, P_2	in.	3.08
5. Land slope, s	ft./ft.	0.080
6. $T_t = \frac{0.007 (nL)^{0.8}}{P_2^{0.5} (s^{0.4})}$	hr.	0.233 = 0.233

Shallow concentrated flow (assume hyd. radius = depth of flow)

	Segment ID				
7. Surface description					
8. Manning's roughness coeff., n					
9. Paved or unpaved					
10. Depth of flow, d (default values: d=.4 unpaved, d=.2 paved)	ft.				
11. Flow Length, L	ft.				
12. Watercourse slope, s	ft./ft.				
13. Average velocity, $V = \frac{1.49}{n} (d^{2/3})(s^{1/2})$	fps.				
14. $T_t = \frac{L}{3600 * V}$	hr.				= 0.000

Channel flow

	Segment ID				
15. Channel Bottom width, b	ft.				
16. Horizontal side slope component, z (z horiz:1 vert)	ft.				
17. Depth of flow, d	ft.				
18. Cross sectional flow area, A (assume trapazoidal)	ft. ²				
19. Wetted perimeter, P_w	ft.				
20. Hydraulic Radius, $R = \frac{A}{P_w}$	ft.				
21. Channel slope, s	ft./ft.				
22. Manning's roughness coeff., n					
23. $V = \frac{1.49}{n} (R^{2/3})(s^{1/2})$	fps.				
24. Flow length, L	ft.				
25. $T_t = \frac{L}{3600 * V}$	hr.				= 0.000
26. Watershed or subarea T_c or T_t (add T_t in steps 6, 14 & 25)	hr.				0.233

Time of Concentration (T_c) or Travel Time (T_t) Worksheet

Project: Wake Robin Inn Redevelopment By: MCB Date: 07/19/24
 Location: Salisbury, CT Checked: _____ Date: _____
 Circle one: Present Developed Watershed: PRWS-10
 Circle one: T_c T_t Subwatershed: _____

Sheet flow (applicable to T_c only)

	Segment ID	A-B
1. Surface description (Table 3-1)		WOODS
2. Manning's roughness coeff. for sheet flow, n (Table 3-1)		0.400
3. Flow Length, L (< 300ft)	ft.	100.0
4. Two-year 24-hr rainfall, P_2	in.	3.08
5. Land slope, s	ft./ft.	48.000
6. $T_t = \frac{0.007 (nL)^{0.8}}{P_2^{0.5} (s^{0.4})}$	hr.	0.016 = 0.016

Shallow concentrated flow (assume hyd. radius = depth of flow)

	Segment ID				
7. Surface description					
8. Manning's roughness coeff., n					
9. Paved or unpaved					
10. Depth of flow, d (default values: d=.4 unpaved, d=.2 paved)	ft.				
11. Flow Length, L	ft.				
12. Watercourse slope, s	ft./ft.				
13. Average velocity, $V = \frac{1.49}{n} (d^{2/3})(s^{1/2})$	fps.				
14. $T_t = \frac{L}{3600 * V}$	hr.				= 0.000

Channel flow

	Segment ID				
15. Channel Bottom width, b	ft.				
16. Horizontal side slope component, z (z horiz:1 vert)	ft.				
17. Depth of flow, d	ft.				
18. Cross sectional flow area, A (assume trapazoidal)	ft. ²				
19. Wetted perimeter, P_w	ft.				
20. Hydraulic Radius, $R = \frac{A}{P_w}$	ft.				
21. Channel slope, s	ft./ft.				
22. Manning's roughness coeff., n					
23. $V = \frac{1.49}{n} (R^{2/3})(s^{1/2})$	fps.				
24. Flow length, L	ft.				
25. $T_t = \frac{L}{3600 * V}$	hr.				= 0.000
26. Watershed or subarea T_c or T_t (add T_t in steps 6, 14 & 25)	hr.				0.016 Min $T_c = 0.1$ hr

Time of Concentration (T_c) or Travel Time (T_t) Worksheet

Project: Wake Robin Inn Redevelopment By: MCB Date: 07/19/24
 Location: Salisbury, CT Checked: _____ Date: _____
 Circle one: Present Developed Watershed: PRWS-11
 Circle one: T_c T_t Subwatershed: _____

Sheet flow (applicable to T_c only)

	Segment ID	A-B
1. Surface description (Table 3-1)		WOODS
2. Manning's roughness coeff. for sheet flow, n (Table 3-1)		0.400
3. Flow Length, L (< 300ft)	ft.	100.0
4. Two-year 24-hr rainfall, P_2	in.	3.08
5. Land slope, s	ft./ft.	0.035
6. $T_t = \frac{0.007(nL)^{0.8}}{P_2^{0.5}(s^{0.4})}$	hr.	0.292
		= 0.292

Shallow concentrated flow (assume hyd. radius = depth of flow)

	Segment ID	B-C			
7. Surface description		WOODS			
8. Manning's roughness coeff., n		0.100			
9. Paved or unpaved		UNPVD			
10. Depth of flow, d (default values: d=.4 unpaved, d=.2 paved)	ft.	0.40			
11. Flow Length, L	ft.	1176.0			
12. Watercourse slope, s	ft./ft.	0.013			
13. Average velocity, $V = \frac{1.49}{n}(d^{2/3})(s^{1/2})$	fps.	0.92			
14. $T_t = \frac{L}{3600 * V}$	hr.	0.354			
					= 0.354

Channel flow

	Segment ID	C-D	D-E		
15. Channel Bottom width, b	ft.	12" RCP	6.00		
16. Horizontal side slope component, z (z horiz:1 vert)	ft.	--	4.00		
17. Depth of flow, d	ft.	FULL	1.00		
18. Cross sectional flow area, A (assume trapazoidal)	ft. ²	0.79	10.00		
19. Wetted perimeter, P_w	ft.	3.14	14.25		
20. Hydraulic Radius, $R = \frac{A}{P_w}$	ft.	0.25	0.70		
21. Channel slope, s	ft./ft.	0.006	0.057		
22. Manning's roughness coeff., n		0.013	0.024		
23. $V = \frac{1.49}{n}(R^{2/3})(s^{1/2})$	fps.	3.54	11.71		
24. Flow length, L	ft.	31.0	514.0		
25. $T_t = \frac{L}{3600 * V}$	hr.	0.002	0.012		
26. Watershed or subarea T_c or T_t (add T_t in steps 6, 14 & 25)	hr.				= 0.015
					0.660

Time of Concentration (T_c) or Travel Time (T_t) Worksheet

Project: Wake Robin Inn Redevelopment By: MCB Date: 07/19/24
 Location: Salisbury, CT Checked: _____ Date: _____
 Circle one: Present Developed Watershed: PRWS-12
 Circle one: T_c T_t Subwatershed: _____

Sheet flow (applicable to T_c only)

	Segment ID				
1. Surface description (Table 3-1)	A-B				
2. Manning's roughness coeff. for sheet flow, n (Table 3-1)	GRASS				
3. Flow Length, L (< 300ft)	0.240				
4. Two-year 24-hr rainfall, P_2	ft. 50.0				
5. Land slope, s	in. 3.08				
	ft./ft. 0.100				
6. $T_t = \frac{0.007 (nL)^{0.8}}{P_2^{0.5} (s^{0.4})}$	hr. 0.073	=		0.073	

Shallow concentrated flow (assume hyd. radius = depth of flow)

	Segment ID				
7. Surface description	B-C				
8. Manning's roughness coeff., n	BIT				
9. Paved or unpaved	0.010				
10. Depth of flow, d (default values: d=.4 unpaved, d=.2 paved) ft.	PVD				
11. Flow Length, L	0.20				
12. Watercourse slope, s	ft. 182.0				
	ft./ft. 0.027				
13. Average velocity, $V = \frac{1.49}{n} (d^{2/3})(s^{1/2})$	fps. 8.37				
14. $T_t = \frac{L}{3600 * V}$	hr. 0.006	+		=	0.006

Channel flow

	Segment ID				
15. Channel Bottom width, b	C-D				
16. Horizontal side slope component, z (z horiz:1 vert) ft.	15" HDPE				
17. Depth of flow, d	--				
18. Cross sectional flow area, A (assume trapazoidal) ft. ²	FULL				
19. Wetted perimeter, P_w	1.23				
	ft. 3.93				
20. Hydraulic Radius, $R = \frac{A}{P_w}$	ft. 0.31				
21. Channel slope, s	ft./ft. 0.01				
22. Manning's roughness coeff., n	0.012				
23. $V = \frac{1.49}{n} (R^{2/3})(s^{1/2})$	fps. 5.72				
24. Flow length, L	ft. 224.0				
25. $T_t = \frac{L}{3600 * V}$	hr. 0.011			=	0.011
26. Watershed or subarea T_c or T_t (add T_t in steps 6, 14 & 25)					0.000

hr. 0.000
Min $T_c = 0.1$ hr

Time of Concentration (T_c) or Travel Time (T_t) Worksheet

Project: Wake Robin Inn Redevelopment By: MCB Date: 07/19/24
 Location: Salisbury, CT Checked: _____ Date: _____
 Circle one: Present Developed Watershed: PRWS-20
 Circle one: T_c T_t Subwatershed: _____

Sheet flow (applicable to T_c only)

	Segment ID	A-B	
1. Surface description (Table 3-1)		WOODS	
2. Manning's roughness coeff. for sheet flow, n (Table 3-1)		0.400	
3. Flow Length, L (< 300ft)	ft.	100.0	
4. Two-year 24-hr rainfall, P_2	in.	3.08	
5. Land slope, s	ft./ft.	0.060	
6. $T_t = \frac{0.007 (nL)^{0.8}}{P_2^{0.5} (s^{0.4})}$	hr.	0.235	= 0.235

Shallow concentrated flow (assume hyd. radius = depth of flow)

	Segment ID	B-C	C-D	D-E	
7. Surface description		GRASS	BIT	GRASS	
8. Manning's roughness coeff., n		0.080	0.010	0.080	
9. Paved or unpaved		UNPVD	PVD	UNPVD	
10. Depth of flow, d (default values: d=.4 unpaved, d=.2 paved)	ft.	0.40	0.20	0.40	
11. Flow Length, L	ft.	80.0	123.0	64.0	
12. Watercourse slope, s	ft./ft.	0.113	0.114	0.078	
13. Average velocity, $V = \frac{1.49}{n} (d^{2/3})(s^{1/2})$	fps.	3.40	17.21	2.82	
14. $T_t = \frac{L}{3600 * V}$	hr.	0.007	+ 0.002	+ 0.006	= 0.015

Channel flow

	Segment ID	E-F			
15. Channel Bottom width, b	ft.	15" HDPE			
16. Horizontal side slope component, z (z horiz:1 vert)	ft.	--			
17. Depth of flow, d	ft.	FULL			
18. Cross sectional flow area, A (assume trapazoidal)	ft. ²	1.23			
19. Wetted perimeter, P_w	ft.	3.93			
20. Hydraulic Radius, $R = \frac{A}{P_w}$	ft.	0.31			
21. Channel slope, s	ft./ft.	0.01			
22. Manning's roughness coeff., n		0.012			
23. $V = \frac{1.49}{n} (R^{2/3})(s^{1/2})$	fps.	5.72			
24. Flow length, L	ft.	119.0			
25. $T_t = \frac{L}{3600 * V}$	hr.	0.006			= 0.006
26. Watershed or subarea T_c or T_t (add T_t in steps 6, 14 & 25)	hr.				= 0.256

Time of Concentration (T_c) or Travel Time (T_t) Worksheet

Project: Wake Robin Inn Redevelopment
 Location: Salisbury, CT
 Circle one: Present Developed
 Circle one: T_c T_t

By: MCB
 Checked: _____
 Watershed: PRWS-21
 Subwatershed: _____
 Date: 07/19/24
 Date: _____

Sheet flow (applicable to T_c only)

1. Surface description (Table 3-1)
2. Manning's roughness coeff. for sheet flow, n (Table 3-1)
3. Flow Length, L (< 300ft)
4. Two-year 24-hr rainfall, P_2
5. Land slope, s
6. $T_t = \frac{0.007 (nL)^{0.8}}{P_2^{0.5} (s^{0.4})}$

Segment ID	A-B			
	GRASS			
	0.240			
ft.	50.0			
in.	3.08			
ft./ft.	0.060			
hr.	0.090	=		0.090

Shallow concentrated flow (assume hyd. radius = depth of flow)

7. Surface description
8. Manning's roughness coeff., n
9. Paved or unpaved
10. Depth of flow, d (default values: d=.4 unpaved, d=.2 paved) ft.
11. Flow Length, L
12. Watercourse slope, s
13. Average velocity, $V = \frac{1.49}{n} (d^{2/3})(s^{1/2})$
14. $T_t = \frac{L}{3600 * V}$

Segment ID	B-C			
	GRASS			
	0.080			
	UNPVD			
ft.	0.40			
ft.	124.0			
ft./ft.	0.097			
fps.	3.15			
hr.	0.011	+		0.011

Channel flow

15. Channel Bottom width, b
16. Horizontal side slope component, z (z horiz:1 vert) ft.
17. Depth of flow, d
18. Cross sectional flow area, A (assume trapazoidal) ft.²
19. Wetted perimeter, P_w
20. Hydraulic Radius, $R = \frac{A}{P_w}$
21. Channel slope, s
22. Manning's roughness coeff., n
23. $V = \frac{1.49}{n} (R^{2/3})(s^{1/2})$
24. Flow length, L
25. $T_t = \frac{L}{3600 * V}$
26. Watershed or subarea T_c or T_t (add T_t in steps 6, 14 & 25)

Segment ID	C-D			
ft.	15" HDPE			
	--			
ft.	FULL			
ft. ²	1.23			
ft.	3.93			
ft.	0.31			
ft./ft.	0.01			
	0.012			
fps.	5.72			
ft.	274.0			
hr.	0.013			0.013
hr.				0.114

Time of Concentration (T_c) or Travel Time (T_t) Worksheet

Project: Wake Robin Inn Redevelopment By: MCB Date: 07/19/24
 Location: Salisbury, CT Checked: _____ Date: _____
 Circle one: Present Developed Watershed: PRWS-22
 Circle one: T_c T_t Subwatershed: _____

Sheet flow (applicable to T_c only)

	Segment ID	A-B	
1. Surface description (Table 3-1)		GRASS	
2. Manning's roughness coeff. for sheet flow, n (Table 3-1)		0.240	
3. Flow Length, L (< 300ft)	ft.	57.0	
4. Two-year 24-hr rainfall, P_2	in.	3.08	
5. Land slope, s	ft./ft.	0.158	
6. $T_t = \frac{0.007(nL)^{0.8}}{P_2^{0.5}(s^{0.4})}$	hr.	0.068	= 0.068

Shallow concentrated flow (assume hyd. radius = depth of flow)

	Segment ID	B-C	C-D		
7. Surface description		BIT	GRASS		
8. Manning's roughness coeff., n		0.010	0.080		
9. Paved or unpaved		PVD	UNPVD		
10. Depth of flow, d (default values: d=.4 unpaved, d=.2 paved)	ft.	0.20	0.40		
11. Flow Length, L	ft.	38.0	55.0		
12. Watercourse slope, s	ft./ft.	0.053	0.055		
13. Average velocity, $V = \frac{1.49}{n}(d^{2/3})(s^{1/2})$	fps.	11.73	2.37		
14. $T_t = \frac{L}{3600 * V}$	hr.	0.001	0.006		= 0.007

Channel flow

	Segment ID	D-E			
15. Channel Bottom width, b	ft.	15" HDPE			
16. Horizontal side slope component, z (z horiz:1 vert)	ft.	--			
17. Depth of flow, d	ft.	FULL			
18. Cross sectional flow area, A (assume trapazoidal)	ft. ²	1.23			
19. Wetted perimeter, P_w	ft.	3.93			
20. Hydraulic Radius, $R = \frac{A}{P_w}$	ft.	0.31			
21. Channel slope, s	ft./ft.	0.01			
22. Manning's roughness coeff., n		0.012			
23. $V = \frac{1.49}{n}(R^{2/3})(s^{1/2})$	fps.	5.72			
24. Flow length, L	ft.	205.0			
25. $T_t = \frac{L}{3600 * V}$	hr.	0.010			= 0.010
26. Watershed or subarea T_c or T_t (add T_t in steps 6, 14 & 25)	hr.				0.065

Min $T_c = 0.1$ hr

Time of Concentration (T_c) or Travel Time (T_t) Worksheet

Project: Wake Robin Inn Redevelopment By: MCB Date: 07/19/24
 Location: Salisbury, CT Checked: _____ Date: _____
 Circle one: Present Developed Watershed: PRWS-30
 Circle one: T_c T_t Subwatershed: _____

Sheet flow (applicable to T_c only)

	Segment ID	A-B
1. Surface description (Table 3-1)		WOODS
2. Manning's roughness coeff. for sheet flow, n (Table 3-1)		0.400
3. Flow Length, L (< 300ft)	ft.	100.0
4. Two-year 24-hr rainfall, P_2	in.	3.08
5. Land slope, s	ft./ft.	0.070
6. $T_t = \frac{0.007 (nL)^{0.8}}{P_2^{0.5} (s^{0.4})}$	hr.	0.221 = 0.221

Shallow concentrated flow (assume hyd. radius = depth of flow)

	Segment ID	B-C			
7. Surface description		WOODS			
8. Manning's roughness coeff., n		0.100			
9. Paved or unpaved		UNPVD			
10. Depth of flow, d (default values: d=.4 unpaved, d=.2 paved)	ft.	0.40			
11. Flow Length, L	ft.	17.0			
12. Watercourse slope, s	ft./ft.	0.070			
13. Average velocity, $V = \frac{1.49}{n} (d^{2/3})(s^{1/2})$	fps.	2.14			
14. $T_t = \frac{L}{3600 * V}$	hr.	0.002			= 0.002

Channel flow

	Segment ID				
15. Channel Bottom width, b	ft.				
16. Horizontal side slope component, z (z horiz:1 vert)	ft.				
17. Depth of flow, d	ft.				
18. Cross sectional flow area, A (assume trapazoidal)	ft. ²				
19. Wetted perimeter, P_w	ft.				
20. Hydraulic Radius, $R = \frac{A}{P_w}$	ft.				
21. Channel slope, s	ft./ft.				
22. Manning's roughness coeff., n					
23. $V = \frac{1.49}{n} (R^{2/3})(s^{1/2})$	fps.				
24. Flow length, L	ft.				
25. $T_t = \frac{L}{3600 * V}$	hr.				= 0.000
26. Watershed or subarea T_c or T_t (add T_t in steps 6, 14 & 25)	hr.				0.223

Wake Robin Soil Samples Falling Head Permeability Test Results
June 24, 2024

Sample	K (in/hr)	K (ft/day)	Sample Depth
SLR-TP-1	10.63	21.26	32"
SLR-TP-2	14.87	29.74	60"
SLR-TP-3	26.42	52.84	32"
SLR-TP-5	1.71	3.41	26"
SLR-TP-7	13.95	27.89	18"



POINT PRECIPITATION FREQUENCY ESTIMATES

Sanja Perica, Sandra Pavlovic, Michael St. Laurent, Carl Trypaluk, Dale Unruh, Orlan Wilhite

NOAA, National Weather Service, Silver Spring, Maryland

[PF tabular](#) | [PF graphical](#) | [Maps & aerials](#)

PF tabular

PDS-based point precipitation frequency estimates with 90% confidence intervals (in inches)¹										
Duration	Average recurrence interval (years)									
	1	2	5	10	25	50	100	200	500	1000
5-min	0.334 (0.255-0.437)	0.396 (0.303-0.518)	0.497 (0.379-0.653)	0.581 (0.441-0.768)	0.697 (0.513-0.960)	0.785 (0.567-1.10)	0.876 (0.614-1.27)	0.973 (0.652-1.45)	1.11 (0.717-1.72)	1.21 (0.769-1.92)
10-min	0.473 (0.362-0.618)	0.561 (0.429-0.734)	0.705 (0.538-0.926)	0.824 (0.624-1.09)	0.988 (0.726-1.36)	1.11 (0.802-1.56)	1.24 (0.870-1.80)	1.38 (0.924-2.06)	1.57 (1.02-2.43)	1.72 (1.09-2.72)
15-min	0.556 (0.426-0.728)	0.660 (0.504-0.864)	0.829 (0.631-1.09)	0.969 (0.734-1.28)	1.16 (0.854-1.60)	1.31 (0.943-1.84)	1.46 (1.02-2.12)	1.62 (1.09-2.42)	1.85 (1.20-2.86)	2.02 (1.28-3.20)
30-min	0.763 (0.584-0.999)	0.906 (0.693-1.19)	1.14 (0.869-1.50)	1.33 (1.01-1.76)	1.60 (1.18-2.21)	1.80 (1.30-2.54)	2.01 (1.42-2.94)	2.24 (1.50-3.36)	2.57 (1.66-3.98)	2.84 (1.80-4.48)
60-min	0.971 (0.743-1.27)	1.15 (0.882-1.51)	1.45 (1.11-1.91)	1.70 (1.29-2.25)	2.04 (1.50-2.82)	2.30 (1.66-3.24)	2.57 (1.81-3.75)	2.87 (1.92-4.29)	3.30 (2.13-5.11)	3.65 (2.31-5.77)
2-hr	1.28 (0.981-1.66)	1.48 (1.14-1.93)	1.82 (1.39-2.37)	2.09 (1.59-2.75)	2.47 (1.83-3.39)	2.76 (2.00-3.86)	3.06 (2.15-4.43)	3.38 (2.28-5.03)	3.82 (2.48-5.90)	4.17 (2.65-6.58)
3-hr	1.47 (1.13-1.90)	1.70 (1.31-2.21)	2.08 (1.60-2.71)	2.39 (1.83-3.14)	2.83 (2.09-3.86)	3.16 (2.29-4.40)	3.49 (2.47-5.05)	3.86 (2.60-5.74)	4.38 (2.85-6.74)	4.79 (3.05-7.54)
6-hr	1.80 (1.39-2.32)	2.12 (1.64-2.75)	2.66 (2.05-3.46)	3.11 (2.39-4.06)	3.73 (2.78-5.10)	4.18 (3.07-5.86)	4.68 (3.35-6.83)	5.26 (3.56-7.81)	6.14 (4.01-9.44)	6.89 (4.40-10.8)
12-hr	2.10 (1.64-2.70)	2.60 (2.02-3.35)	3.42 (2.65-4.42)	4.11 (3.16-5.33)	5.04 (3.80-6.93)	5.73 (4.25-8.08)	6.49 (4.73-9.61)	7.48 (5.06-11.1)	9.08 (5.93-13.9)	10.5 (6.71-16.4)
24-hr	2.41 (1.88-3.08)	3.08 (2.41-3.95)	4.19 (3.26-5.39)	5.11 (3.95-6.61)	6.37 (4.83-8.76)	7.28 (5.45-10.3)	8.32 (6.14-12.4)	9.71 (6.59-14.3)	12.0 (7.87-18.4)	14.1 (9.06-22.0)
2-day	2.75 (2.16-3.50)	3.54 (2.78-4.51)	4.83 (3.78-6.18)	5.91 (4.59-7.60)	7.38 (5.62-10.1)	8.45 (6.35-11.9)	9.66 (7.16-14.4)	11.3 (7.69-16.6)	14.0 (9.21-21.4)	16.5 (10.6-25.6)
3-day	3.00 (2.36-3.81)	3.85 (3.03-4.90)	5.24 (4.11-6.68)	6.39 (4.98-8.20)	7.98 (6.09-10.9)	9.12 (6.87-12.8)	10.4 (7.74-15.5)	12.2 (8.31-17.9)	15.1 (9.95-23.0)	17.8 (11.5-27.6)
4-day	3.22 (2.54-4.08)	4.12 (3.25-5.23)	5.58 (4.38-7.11)	6.80 (5.31-8.71)	8.47 (6.48-11.5)	9.68 (7.30-13.6)	11.0 (8.21-16.3)	12.9 (8.81-18.9)	16.0 (10.5-24.3)	18.8 (12.1-29.0)
7-day	3.84 (3.04-4.85)	4.84 (3.83-6.11)	6.46 (5.10-8.20)	7.82 (6.13-9.97)	9.68 (7.42-13.1)	11.0 (8.33-15.4)	12.5 (9.32-18.4)	14.6 (9.98-21.3)	17.9 (11.8-27.1)	20.8 (13.5-32.2)
10-day	4.48 (3.55-5.63)	5.52 (4.38-6.96)	7.24 (5.72-9.15)	8.66 (6.80-11.0)	10.6 (8.14-14.3)	12.0 (9.09-16.7)	13.6 (10.1-19.9)	15.7 (10.8-22.9)	19.1 (12.6-28.8)	22.0 (14.3-34.0)
20-day	6.52 (5.20-8.16)	7.61 (6.06-9.54)	9.40 (7.46-11.8)	10.9 (8.59-13.8)	12.9 (9.92-17.2)	14.4 (10.9-19.7)	16.1 (11.8-23.0)	18.1 (12.5-26.2)	21.2 (14.1-32.0)	23.9 (15.6-36.8)
30-day	8.23 (6.58-10.3)	9.34 (7.46-11.7)	11.2 (8.89-14.0)	12.7 (10.0-16.0)	14.8 (11.3-19.5)	16.3 (12.3-22.1)	18.0 (13.2-25.4)	19.9 (13.8-28.8)	22.7 (15.2-34.1)	25.1 (16.4-38.5)
45-day	10.3 (8.29-12.9)	11.5 (9.21-14.3)	13.4 (10.7-16.8)	15.0 (11.9-18.9)	17.2 (13.2-22.5)	18.8 (14.2-25.2)	20.5 (14.9-28.5)	22.3 (15.5-32.1)	24.7 (16.6-37.0)	26.6 (17.4-40.8)
60-day	12.1 (9.70-15.0)	13.3 (10.7-16.6)	15.3 (12.2-19.1)	17.0 (13.5-21.3)	19.3 (14.8-25.1)	21.1 (15.8-28.1)	22.8 (16.5-31.4)	24.5 (17.1-35.1)	26.6 (17.8-39.6)	28.0 (18.3-42.9)

¹ Precipitation frequency (PF) estimates in this table are based on frequency analysis of partial duration series (PDS). Numbers in parenthesis are PF estimates at lower and upper bounds of the 90% confidence interval. The probability that precipitation frequency estimates (for a given duration and average recurrence interval) will be greater than the upper bound (or less than the lower bound) is 5%. Estimates at upper bounds are not checked against probable maximum precipitation (PMP) estimates and may be higher than currently valid PMP values. Please refer to NOAA Atlas 14 document for more information.

[Back to Top](#)

PF graphical

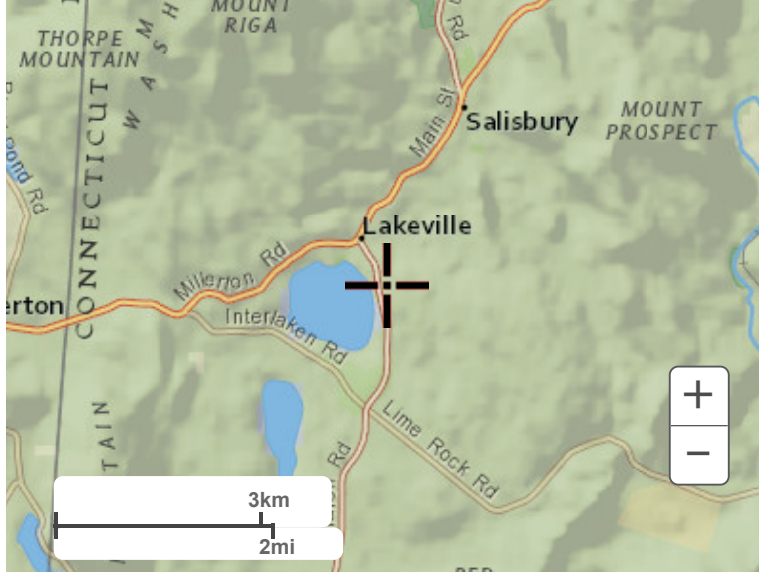

Large scale terrain



Large scale map

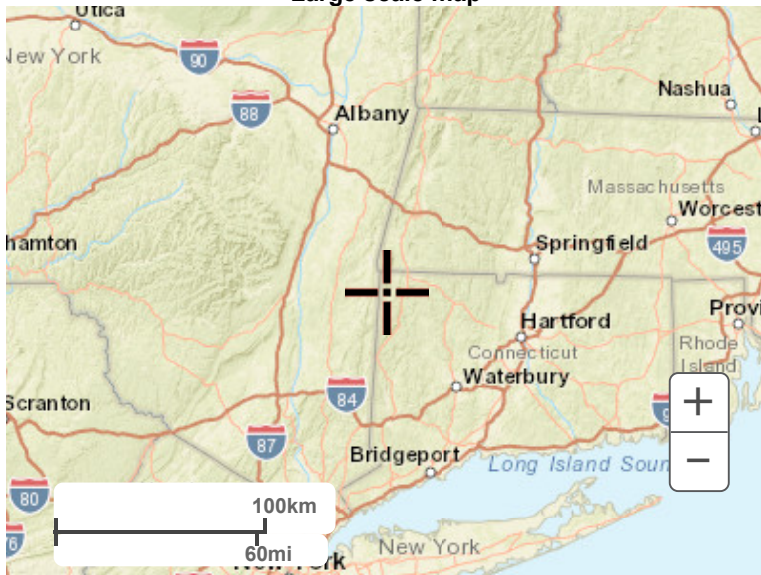

Large scale aerial

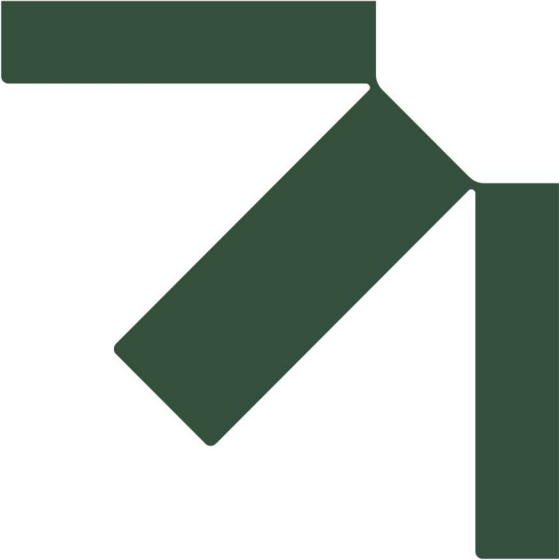

Appendix G

Hydrologic Analysis-Computer Model Results

Wake Robin Inn Redevelopment

104 & 106 Sharon Road, Salisbury, Connecticut

Drainage Report

Prepared for:
Aradev LLC
352 Atlantic Avenue, Unit 2
Brooklyn, NY 11217

SLR Project No.: 141.22100.00001

July 19, 2024

Revised August 1, 2024



Hydrographs Peak Flowrate Summary (cfs) Existing vs. Proposed

Storm Event	2yr		10yr		25yr		50yr		100yr	
	Exist	Prop	Exist	Prop	Exist	Prop	Exist	Prop	Exist	Prop
Point of Analysis A	7.5	7.3	21.5	21.2	31.3	30.5	38.6	37.4	47.1	45.4
UG 120 W.S. Elev. (ft.) Inside Top of Chamber Elev. = 819.0	-	816.6	-	818.1	-	818.4	-	818.5	-	818.6
Plunge Pool 120 W.S. Elev. (ft.) Top of Berm Elev. = 816.0	-	815.0	-	815.1	-	815.1	-	815.2	-	815.2
Point of Analysis B	5.8	3.6	13.1	10.1	17.8	15.1	21.2	18.2	25.2	21.6
DET 210 W.S. Elev. (ft.) Top of Berm Elev. = 818.0	-	815.4	-	816.0	-	816.4	-	816.7	-	816.9
DET 220 W.S. Elev. (ft.) Top of Berm Elev. = 804.0	-	801.9	-	802.7	-	802.8	-	802.9	-	802.9
Point of Analysis C	1.6	1.5	4.0	3.4	5.6	4.7	6.8	5.7	8.1	6.7

Study Area

A
B
C

Description

Wells Hill Road
Sharon Road Storm Drainage
Sharon Road and Southern Properties

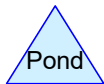
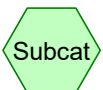
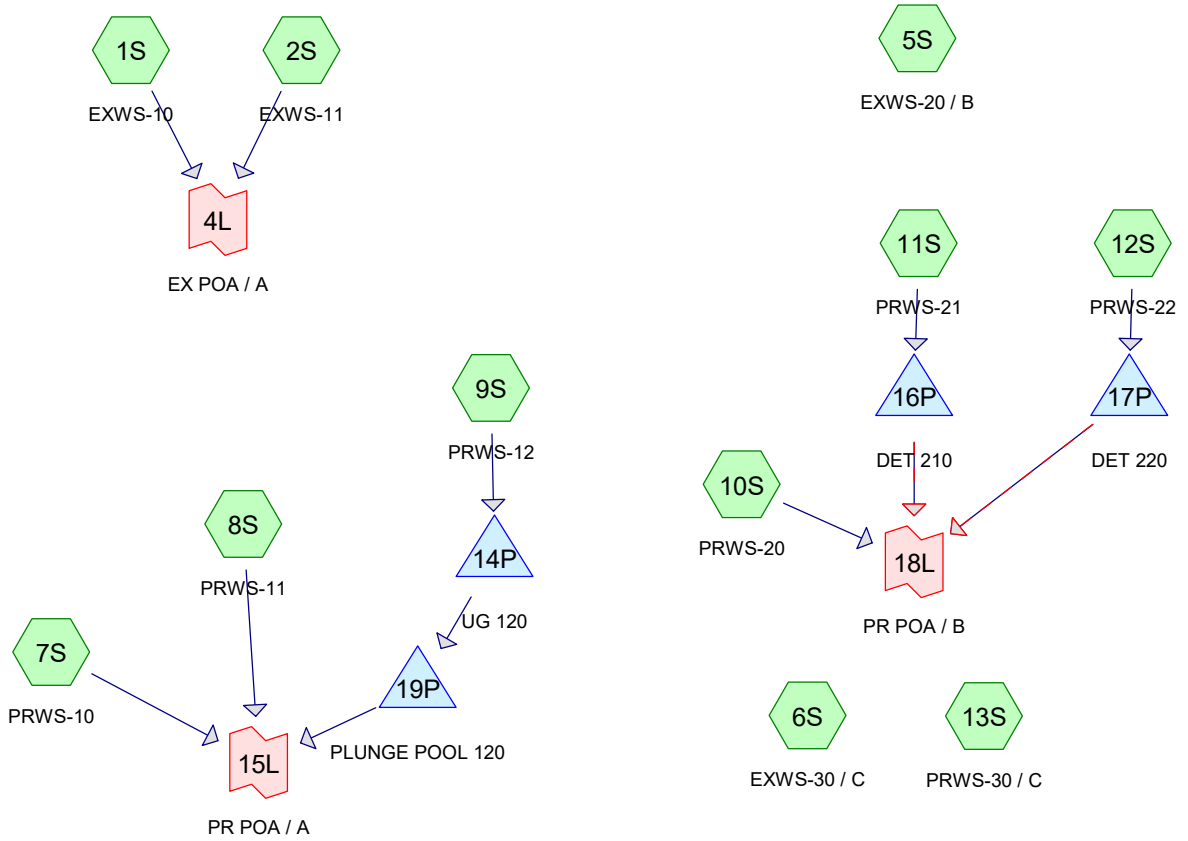

Summary for Subcatchment 1S: EXWS-10

Runoff = 2.21 cfs @ 12.23 hrs, Volume= 0.196 af, Depth> 0.95"
 Routed to Link 4L : EX POA / A

Runoff by SCS TR-20 method, UH=SCS, Weighted-CN, Time Span= 5.00-20.00 hrs, dt= 0.05 hrs
 NOAA 24-hr D 2-Year Rainfall=3.08"

Area (ac)	CN	Description
* 2.460	76	
2.460		100.00% Pervious Area

Tc (min)	Length (feet)	Slope (ft/ft)	Velocity (ft/sec)	Capacity (cfs)	Description
14.2					Direct Entry,

Subcatchment 1S: EXWS-10

Hydrograph

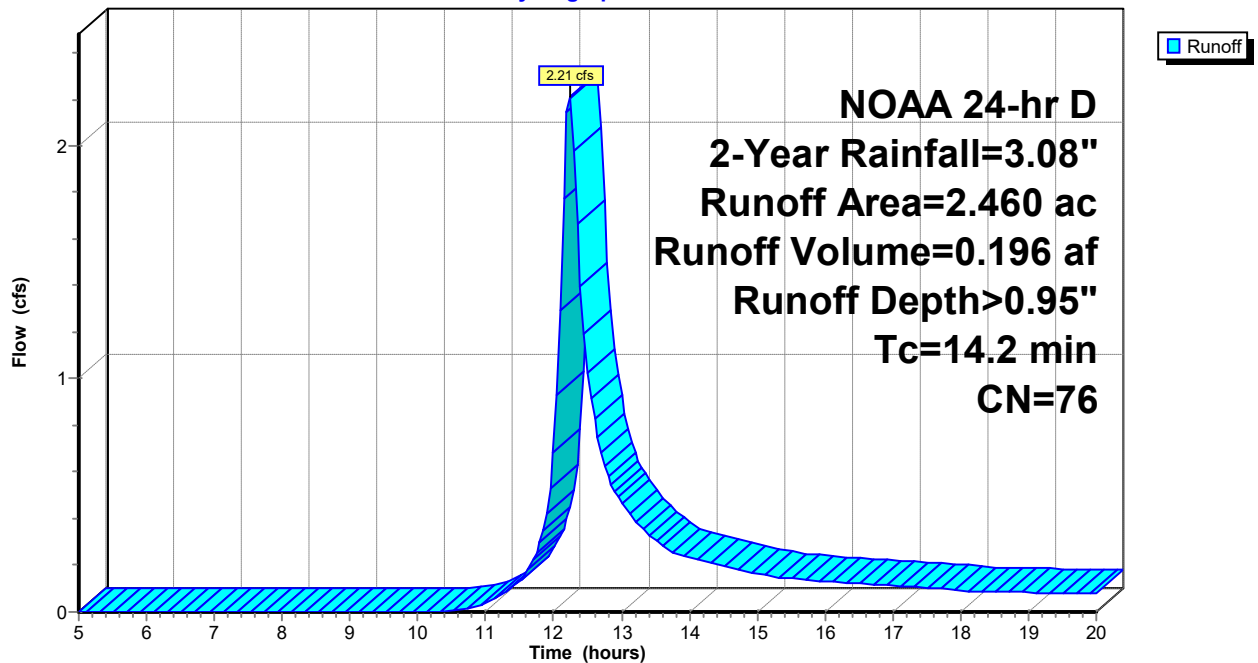

Summary for Subcatchment 2S: EXWS-11

Runoff = 6.68 cfs @ 12.60 hrs, Volume= 0.994 af, Depth> 0.74"
 Routed to Link 4L : EX POA / A

Runoff by SCS TR-20 method, UH=SCS, Weighted-CN, Time Span= 5.00-20.00 hrs, dt= 0.05 hrs
 NOAA 24-hr D 2-Year Rainfall=3.08"

Area (ac)	CN	Description
* 16.050	72	
16.050		100.00% Pervious Area

Tc (min)	Length (feet)	Slope (ft/ft)	Velocity (ft/sec)	Capacity (cfs)	Description
39.6					Direct Entry,

Subcatchment 2S: EXWS-11

Hydrograph

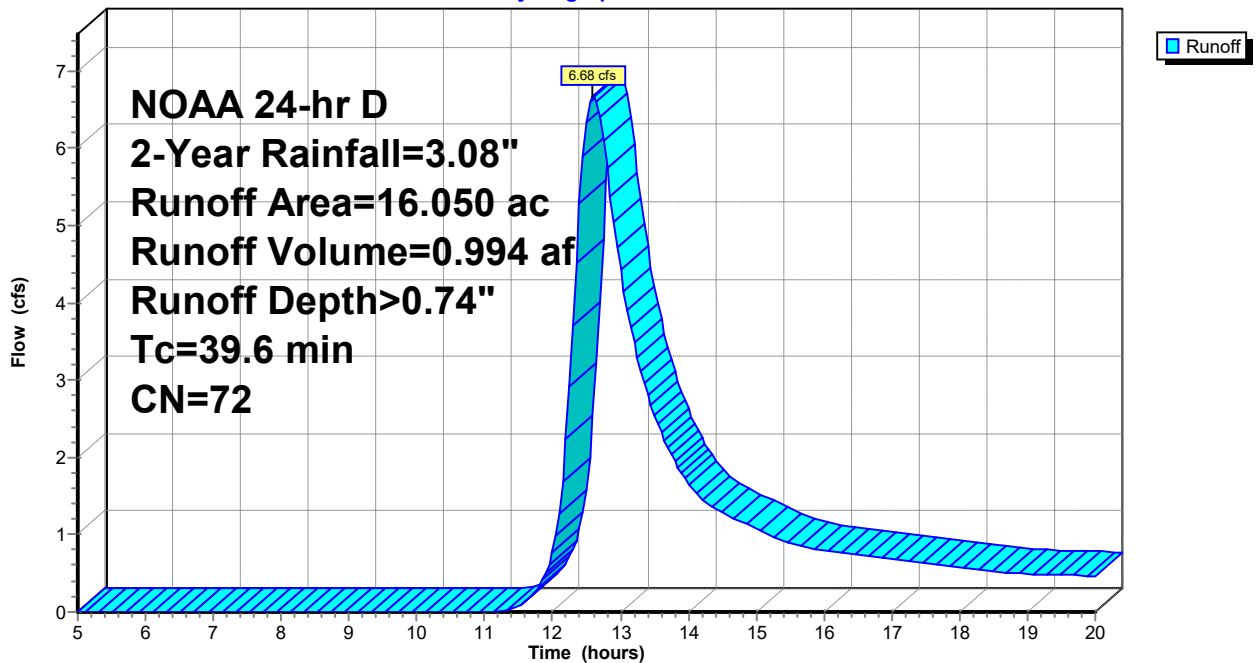

Summary for Subcatchment 5S: EXWS-20 / B

Runoff = 5.84 cfs @ 12.24 hrs, Volume= 0.518 af, Depth> 1.24"

Runoff by SCS TR-20 method, UH=SCS, Weighted-CN, Time Span= 5.00-20.00 hrs, dt= 0.05 hrs
 NOAA 24-hr D 2-Year Rainfall=3.08"

Area (ac)	CN	Description
* 5.000	81	
5.000		100.00% Pervious Area

Tc (min)	Length (feet)	Slope (ft/ft)	Velocity (ft/sec)	Capacity (cfs)	Description
14.9					Direct Entry,

Subcatchment 5S: EXWS-20 / B

Hydrograph

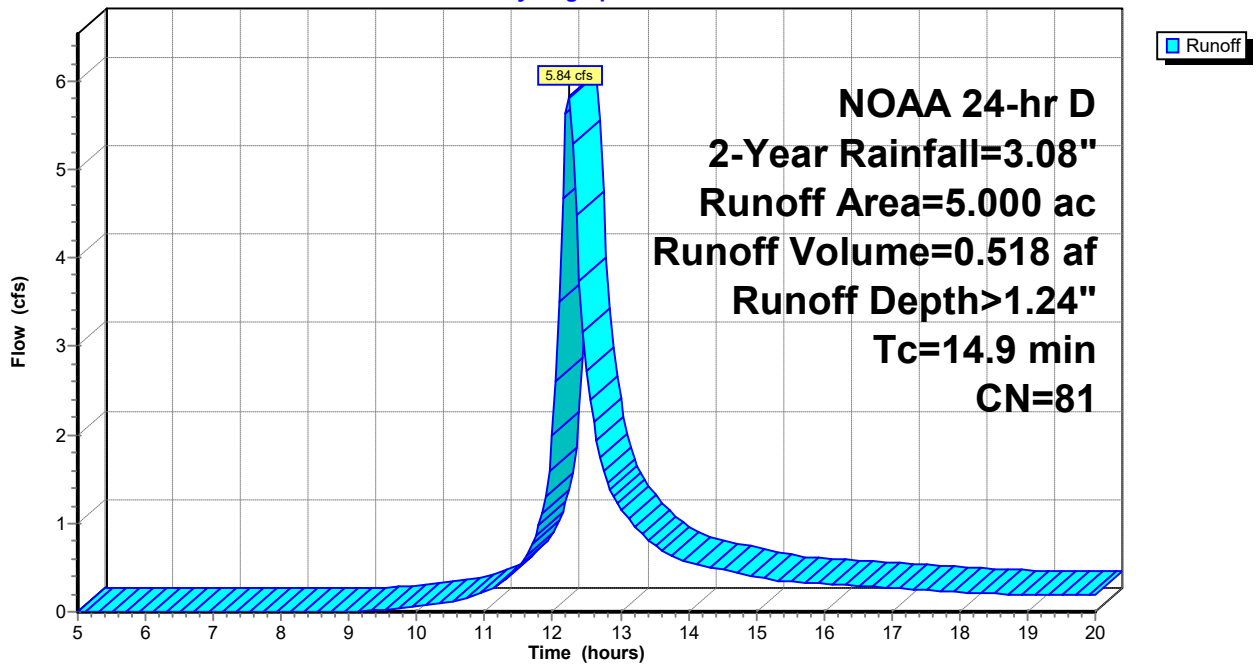

Summary for Subcatchment 6S: EXWS-30 / C

Runoff = 1.61 cfs @ 12.23 hrs, Volume= 0.140 af, Depth> 1.01"

Runoff by SCS TR-20 method, UH=SCS, Weighted-CN, Time Span= 5.00-20.00 hrs, dt= 0.05 hrs
 NOAA 24-hr D 2-Year Rainfall=3.08"

Area (ac)	CN	Description
* 1.670	77	
1.670		100.00% Pervious Area

Tc (min)	Length (feet)	Slope (ft/ft)	Velocity (ft/sec)	Capacity (cfs)	Description
14.0					Direct Entry,

Subcatchment 6S: EXWS-30 / C

Hydrograph

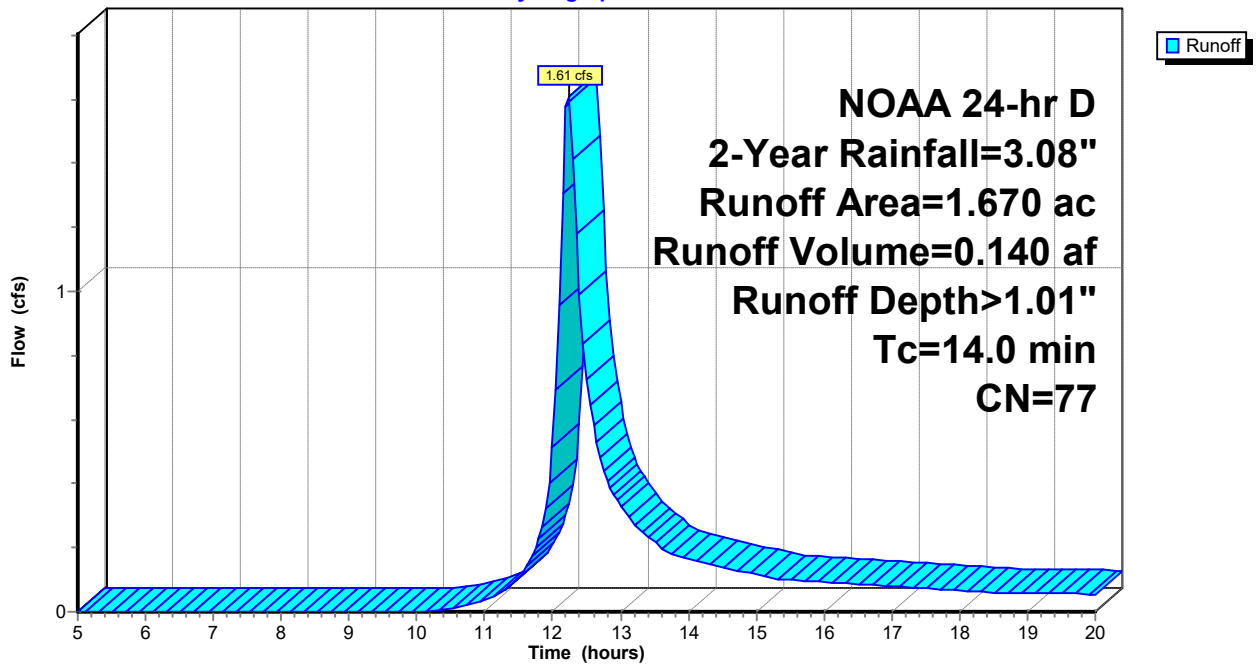

Summary for Subcatchment 7S: PRWS-10

Runoff = 1.73 cfs @ 12.13 hrs, Volume= 0.115 af, Depth> 1.19"
 Routed to Link 15L : PR POA / A

Runoff by SCS TR-20 method, UH=SCS, Weighted-CN, Time Span= 5.00-20.00 hrs, dt= 0.05 hrs
 NOAA 24-hr D 2-Year Rainfall=3.08"

Area (ac)	CN	Description
* 1.160	80	
1.160		100.00% Pervious Area

Tc (min)	Length (feet)	Slope (ft/ft)	Velocity (ft/sec)	Capacity (cfs)	Description
6.0					Direct Entry,

Subcatchment 7S: PRWS-10

Hydrograph

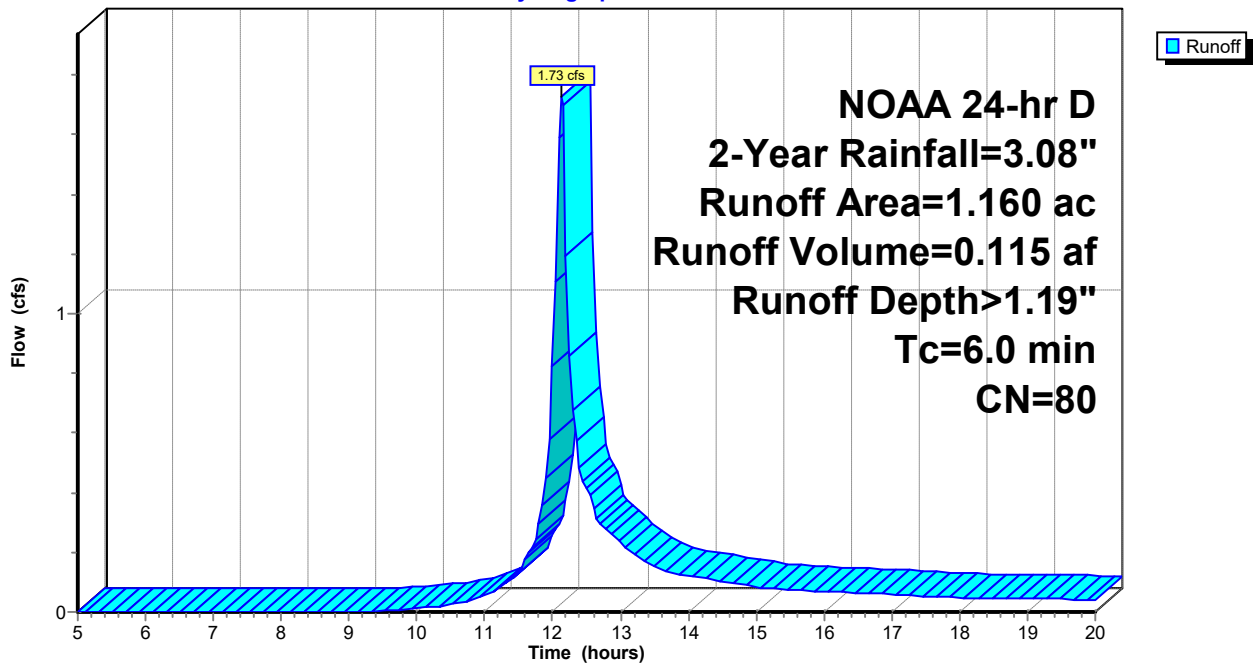

Summary for Subcatchment 8S: PRWS-11

Runoff = 6.95 cfs @ 12.59 hrs, Volume= 1.023 af, Depth> 0.79"
 Routed to Link 15L : PR POA / A

Runoff by SCS TR-20 method, UH=SCS, Weighted-CN, Time Span= 5.00-20.00 hrs, dt= 0.05 hrs
 NOAA 24-hr D 2-Year Rainfall=3.08"

Area (ac)	CN	Description
* 15.530	73	
15.530		100.00% Pervious Area

Tc (min)	Length (feet)	Slope (ft/ft)	Velocity (ft/sec)	Capacity (cfs)	Description
39.6					Direct Entry,

Subcatchment 8S: PRWS-11

Hydrograph

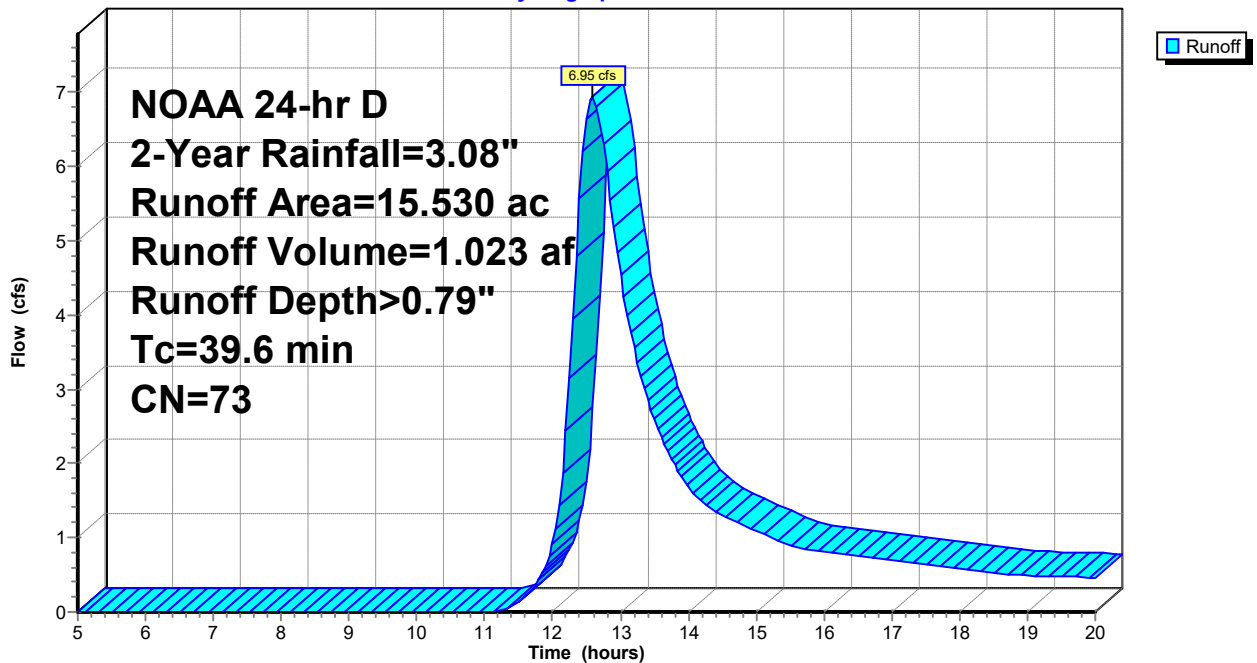

Summary for Subcatchment 9S: PRWS-12

Runoff = 1.94 cfs @ 12.13 hrs, Volume= 0.131 af, Depth> 1.59"
 Routed to Pond 14P : UG 120

Runoff by SCS TR-20 method, UH=SCS, Weighted-CN, Time Span= 5.00-20.00 hrs, dt= 0.05 hrs
 NOAA 24-hr D 2-Year Rainfall=3.08"

Area (ac)	CN	Description
* 0.990	86	
0.990		100.00% Pervious Area

Tc (min)	Length (feet)	Slope (ft/ft)	Velocity (ft/sec)	Capacity (cfs)	Description
6.0					Direct Entry,

Subcatchment 9S: PRWS-12

Hydrograph

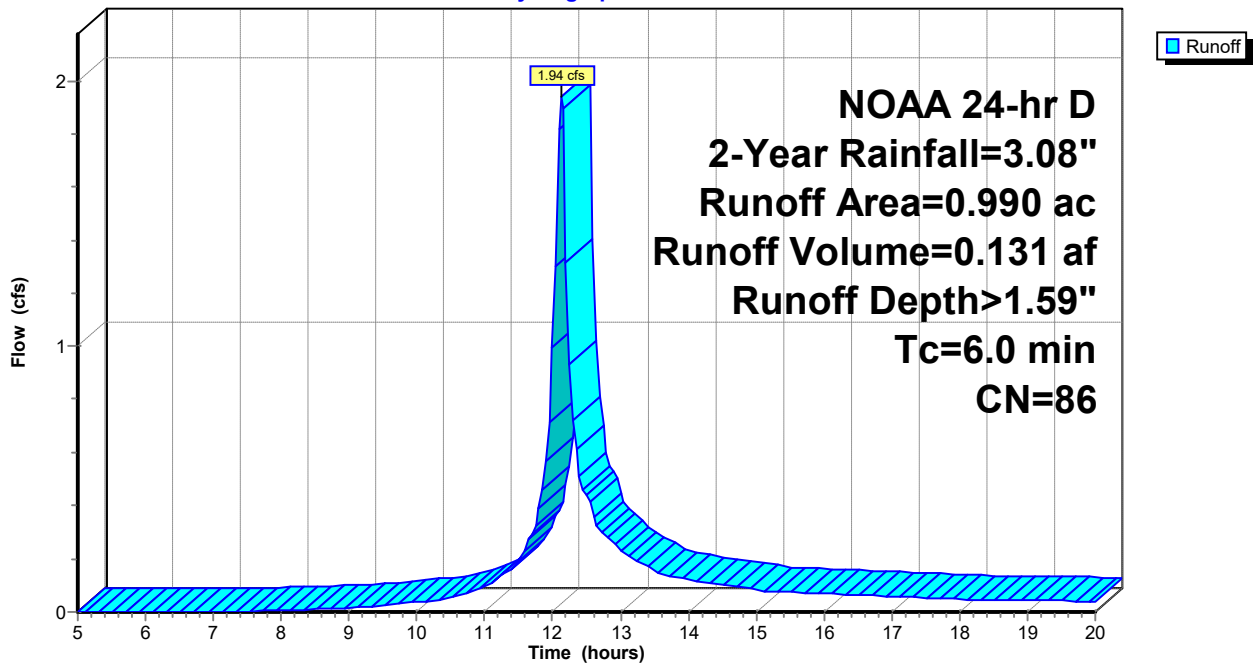

Summary for Subcatchment 10S: PRWS-20

Runoff = 3.58 cfs @ 12.24 hrs, Volume= 0.321 af, Depth> 1.31"
 Routed to Link 18L : PR POA / B

Runoff by SCS TR-20 method, UH=SCS, Weighted-CN, Time Span= 5.00-20.00 hrs, dt= 0.05 hrs
 NOAA 24-hr D 2-Year Rainfall=3.08"

Area (ac)	CN	Description
* 2.950	82	
2.950		100.00% Pervious Area

Tc (min)	Length (feet)	Slope (ft/ft)	Velocity (ft/sec)	Capacity (cfs)	Description
15.4					Direct Entry,

Subcatchment 10S: PRWS-20

Hydrograph

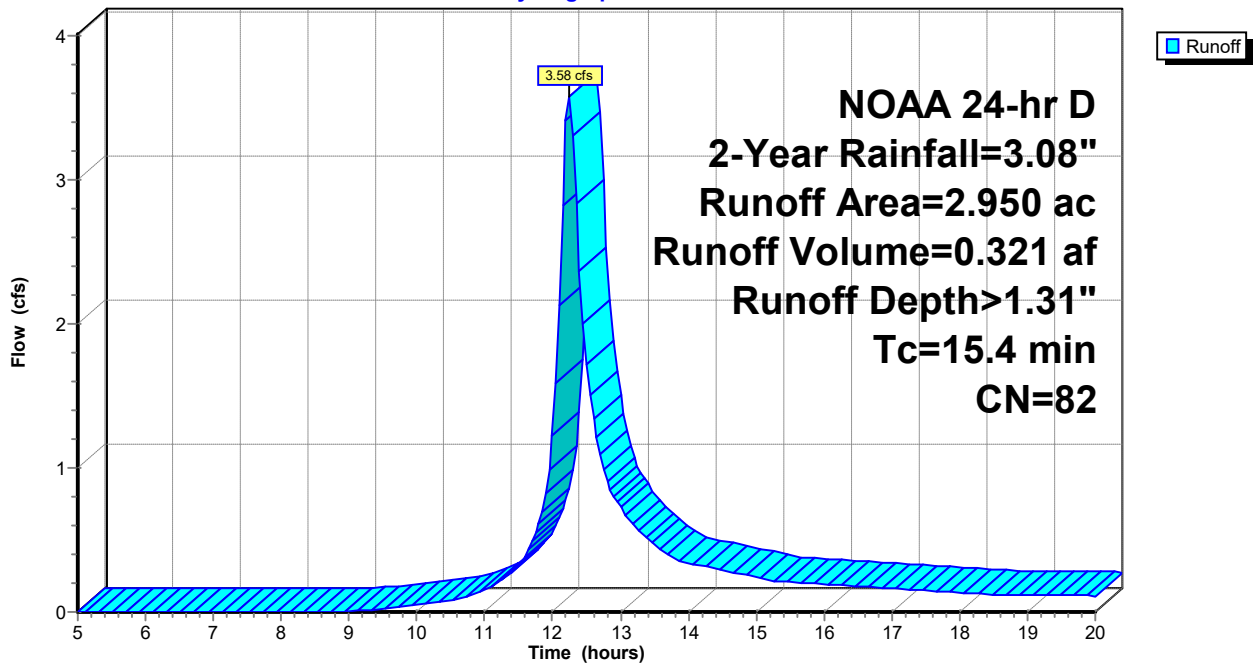

Summary for Subcatchment 11S: PRWS-21

Runoff = 4.64 cfs @ 12.14 hrs, Volume= 0.322 af, Depth> 1.74"
 Routed to Pond 16P : DET 210

Runoff by SCS TR-20 method, UH=SCS, Weighted-CN, Time Span= 5.00-20.00 hrs, dt= 0.05 hrs
 NOAA 24-hr D 2-Year Rainfall=3.08"

Area (ac)	CN	Description
* 2.220	88	
2.220		100.00% Pervious Area

Tc (min)	Length (feet)	Slope (ft/ft)	Velocity (ft/sec)	Capacity (cfs)	Description
6.8					Direct Entry,

Subcatchment 11S: PRWS-21

Hydrograph

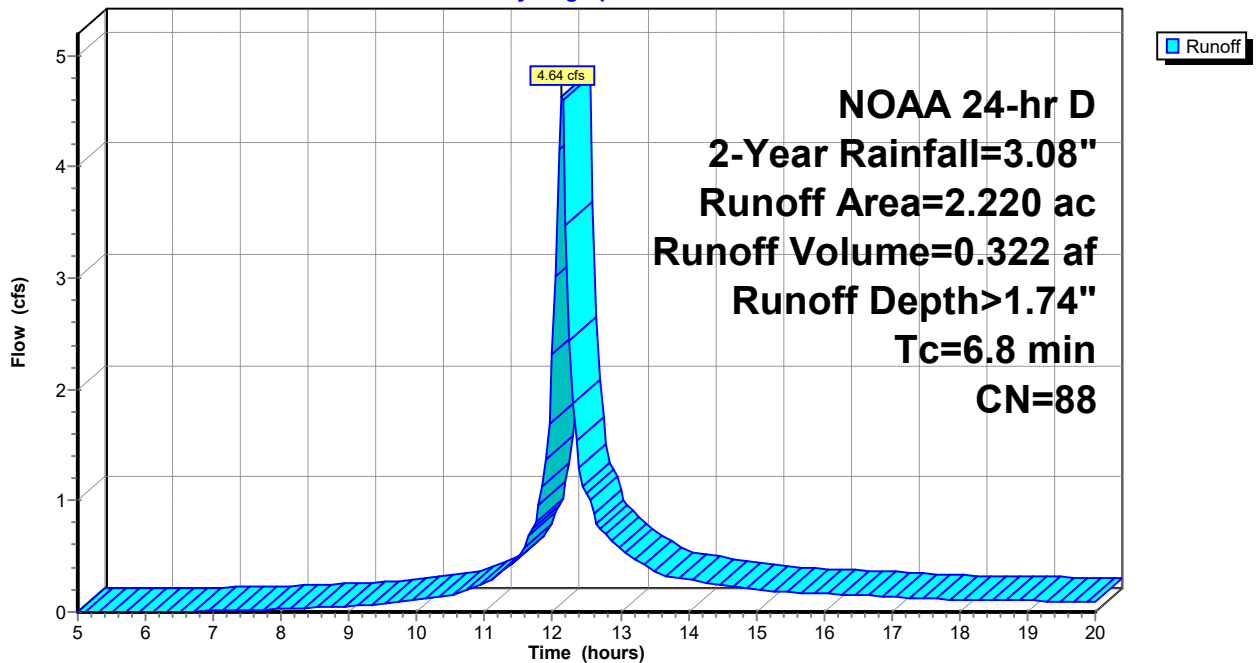

Summary for Subcatchment 12S: PRWS-22

Runoff = 2.36 cfs @ 12.13 hrs, Volume= 0.161 af, Depth> 1.74"
 Routed to Pond 17P : DET 220

Runoff by SCS TR-20 method, UH=SCS, Weighted-CN, Time Span= 5.00-20.00 hrs, dt= 0.05 hrs
 NOAA 24-hr D 2-Year Rainfall=3.08"

Area (ac)	CN	Description
* 1.110	88	
1.110		100.00% Pervious Area

Tc (min)	Length (feet)	Slope (ft/ft)	Velocity (ft/sec)	Capacity (cfs)	Description
6.0					Direct Entry,

Subcatchment 12S: PRWS-22

Hydrograph

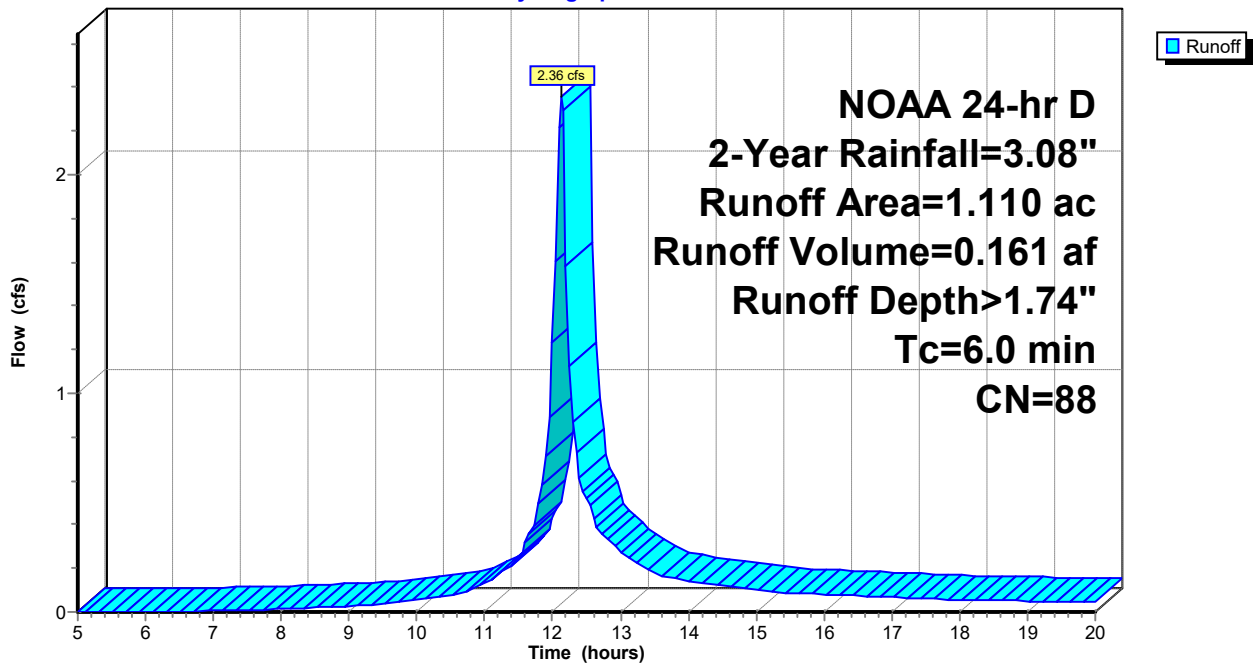

Summary for Subcatchment 13S: PRWS-30 / C

Runoff = 1.45 cfs @ 12.22 hrs, Volume= 0.124 af, Depth> 1.12"

Runoff by SCS TR-20 method, UH=SCS, Weighted-CN, Time Span= 5.00-20.00 hrs, dt= 0.05 hrs
 NOAA 24-hr D 2-Year Rainfall=3.08"

Area (ac)	CN	Description
* 1.320	79	
1.320		100.00% Pervious Area

Tc (min)	Length (feet)	Slope (ft/ft)	Velocity (ft/sec)	Capacity (cfs)	Description
13.4					Direct Entry,

Subcatchment 13S: PRWS-30 / C

Hydrograph

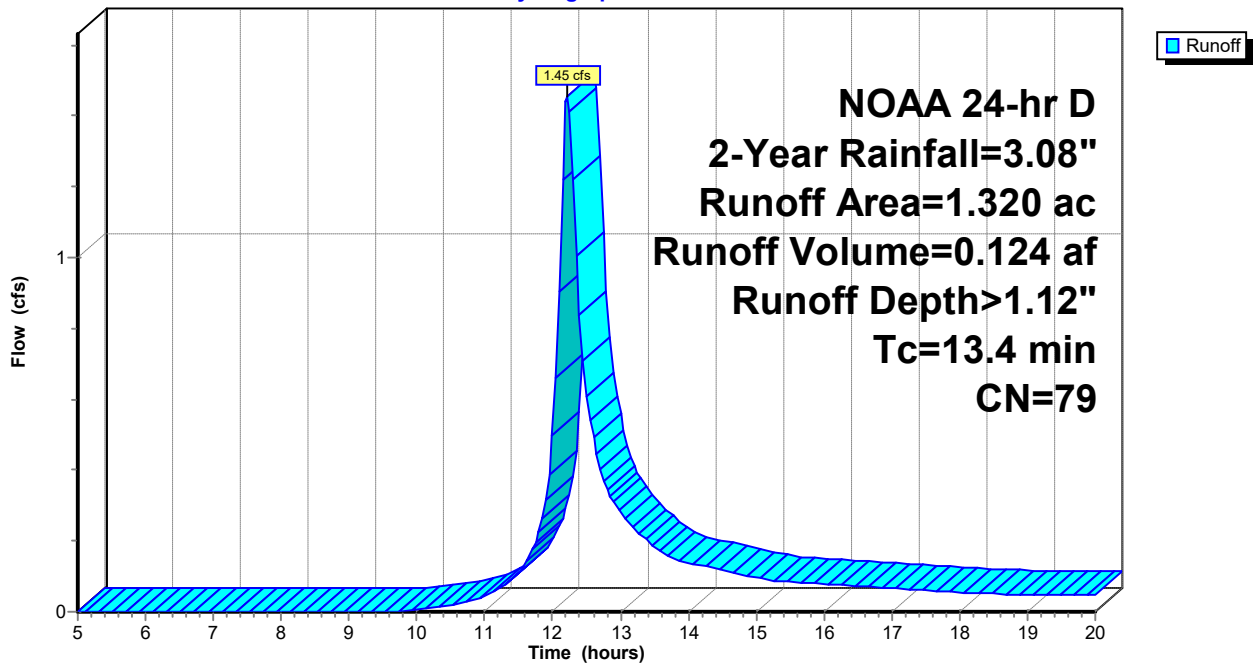

Summary for Pond 14P: UG 120

Inflow Area = 0.990 ac, 0.00% Impervious, Inflow Depth > 1.59" for 2-Year event
 Inflow = 1.94 cfs @ 12.13 hrs, Volume= 0.131 af
 Outflow = 0.26 cfs @ 12.92 hrs, Volume= 0.083 af, Atten= 87%, Lag= 47.4 min
 Discarded = 0.04 cfs @ 10.55 hrs, Volume= 0.033 af
 Primary = 0.22 cfs @ 12.92 hrs, Volume= 0.049 af
 Routed to Pond 19P : PLUNGE POOL 120

Routing by Stor-Ind method, Time Span= 5.00-20.00 hrs, dt= 0.05 hrs
 Peak Elev= 816.64' @ 12.92 hrs Surf.Area= 0.044 ac Storage= 0.063 af

Plug-Flow detention time= 152.4 min calculated for 0.082 af (63% of inflow)
 Center-of-Mass det. time= 76.3 min (866.9 - 790.6)

Volume	Invert	Avail.Storage	Storage Description
#1A	815.00'	0.000 af	24.00'W x 80.00'L x 4.67'H Field A 0.206 af Overall - 0.206 af Embedded = 0.000 af x 40.0% Voids
#2A	815.00'	0.155 af	retain_it retain_it 4.0' x 30 Inside #1 Inside= 84.0"W x 48.0"H => 28.87 sf x 8.00'L = 230.9 cf Outside= 96.0"W x 56.0"H => 37.33 sf x 8.00'L = 298.7 cf 3 Rows adjusted for 196.3 cf perimeter wall
		0.155 af	Total Available Storage

Storage Group A created with Chamber Wizard

Device	Routing	Invert	Outlet Devices
#1	Discarded	815.00'	0.860 in/hr Exfiltration over Surface area
#2	Primary	815.00'	12.0" Round Culvert L= 30.0' CPP, projecting, no headwall, Ke= 0.900 Inlet / Outlet Invert= 815.00' / 814.00' S= 0.0333 '/' Cc= 0.900 n= 0.012, Flow Area= 0.79 sf
#3	Device 2	816.20'	4.0" Vert. Orifice/Grate C= 0.600 Limited to weir flow at low heads
#4	Device 2	818.00'	3.9' long Sharp-Crested Rectangular Weir 2 End Contraction(s)

Discarded OutFlow Max=0.04 cfs @ 10.55 hrs HW=815.05' (Free Discharge)
 ↑ **1=Exfiltration** (Exfiltration Controls 0.04 cfs)

Primary OutFlow Max=0.22 cfs @ 12.92 hrs HW=816.64' (Free Discharge)
 ↑ **2=Culvert** (Passes 0.22 cfs of 3.18 cfs potential flow)
 ↑ **3=Orifice/Grate** (Orifice Controls 0.22 cfs @ 2.50 fps)
 ↑ **4=Sharp-Crested Rectangular Weir** (Controls 0.00 cfs)

Pond 14P: UG 120

Hydrograph

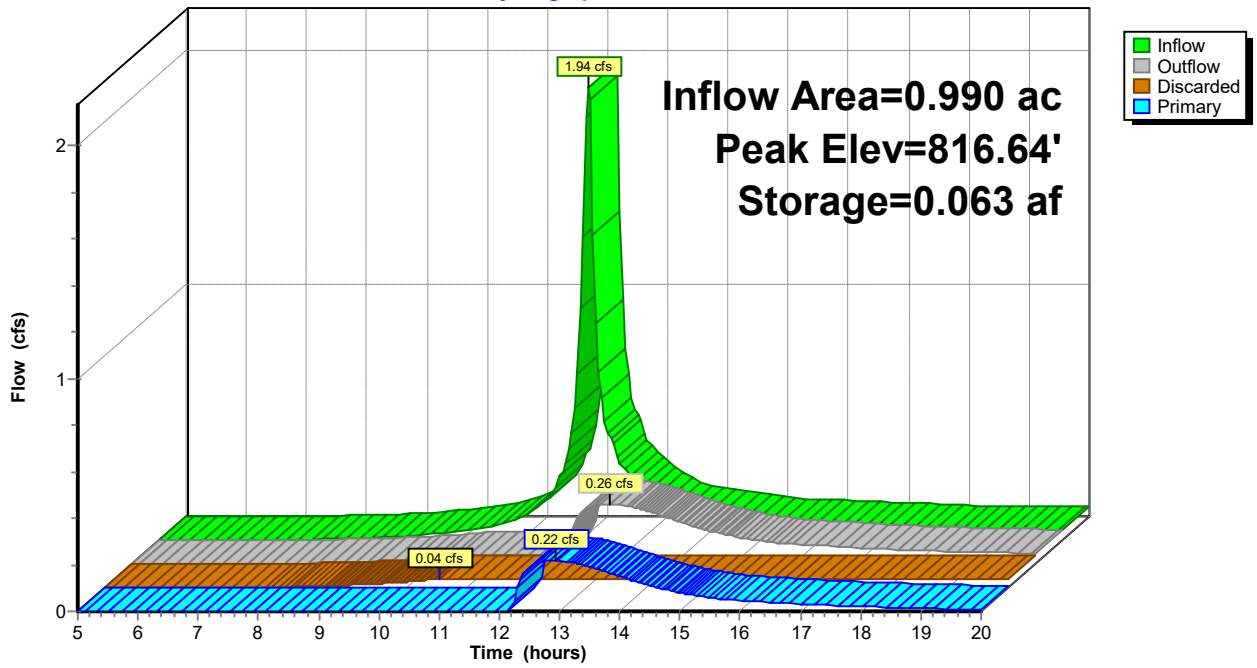

Summary for Pond 16P: DET 210

Inflow Area = 2.220 ac, 0.00% Impervious, Inflow Depth > 1.74" for 2-Year event
 Inflow = 4.64 cfs @ 12.14 hrs, Volume= 0.322 af
 Outflow = 1.19 cfs @ 12.43 hrs, Volume= 0.322 af, Atten= 74%, Lag= 17.7 min
 Discarded = 1.19 cfs @ 12.43 hrs, Volume= 0.322 af
 Primary = 0.00 cfs @ 5.00 hrs, Volume= 0.000 af
 Routed to Link 18L : PR POA / B
 Secondary = 0.00 cfs @ 5.00 hrs, Volume= 0.000 af
 Routed to Link 18L : PR POA / B

Routing by Stor-Ind method, Time Span= 5.00-20.00 hrs, dt= 0.05 hrs
 Peak Elev= 815.37' @ 12.43 hrs Surf.Area= 8,024 sf Storage= 2,911 cf

Plug-Flow detention time= 15.6 min calculated for 0.322 af (100% of inflow)
 Center-of-Mass det. time= 15.1 min (799.5 - 784.4)

Volume	Invert	Avail.Storage	Storage Description		
#1	815.00'	28,806 cf	Custom Stage Data (Conic) Listed below (Recalc)		
Elevation (feet)	Surf.Area (sq-ft)	Inc.Store (cubic-feet)	Cum.Store (cubic-feet)	Wet.Area (sq-ft)	
815.00	7,517	0	0	7,517	
816.00	8,907	8,202	8,202	8,944	
817.00	10,296	9,593	17,795	10,375	
818.00	11,741	11,011	28,806	11,867	

Device	Routing	Invert	Outlet Devices
#1	Discarded	815.00'	6.400 in/hr Exfiltration over Surface area
#2	Primary	815.00'	12.0" Round Culvert L= 127.0' CPP, projecting, no headwall, Ke= 0.900 Inlet / Outlet Invert= 815.00' / 806.40' S= 0.0677 ' / Cc= 0.900 n= 0.012, Flow Area= 0.79 sf
#3	Device 2	815.60'	6.0" Vert. Orifice/Grate C= 0.600 Limited to weir flow at low heads
#4	Device 2	816.80'	14.0' long Sharp-Crested Rectangular Weir 2 End Contraction(s)
#5	Secondary	817.00'	10.0' long + 3.0 ' SideZ x 8.0' breadth Broad-Crested Rectangular Weir Head (feet) 0.20 0.40 0.60 0.80 1.00 1.20 1.40 1.60 1.80 2.00 2.50 3.00 3.50 4.00 4.50 5.00 5.50 Coef. (English) 2.43 2.54 2.70 2.69 2.68 2.68 2.66 2.64 2.64 2.64 2.65 2.65 2.66 2.66 2.68 2.70 2.74

Discarded OutFlow Max=1.19 cfs @ 12.43 hrs HW=815.37' (Free Discharge)
 ↑1=Exfiltration (Exfiltration Controls 1.19 cfs)

Primary OutFlow Max=0.00 cfs @ 5.00 hrs HW=815.00' (Free Discharge)
 ↑2=Culvert (Controls 0.00 cfs)
 ↑3=Orifice/Grate (Controls 0.00 cfs)
 ↑4=Sharp-Crested Rectangular Weir (Controls 0.00 cfs)

Secondary OutFlow Max=0.00 cfs @ 5.00 hrs HW=815.00' (Free Discharge)
 ↑5=Broad-Crested Rectangular Weir (Controls 0.00 cfs)

Pond 16P: DET 210

Hydrograph

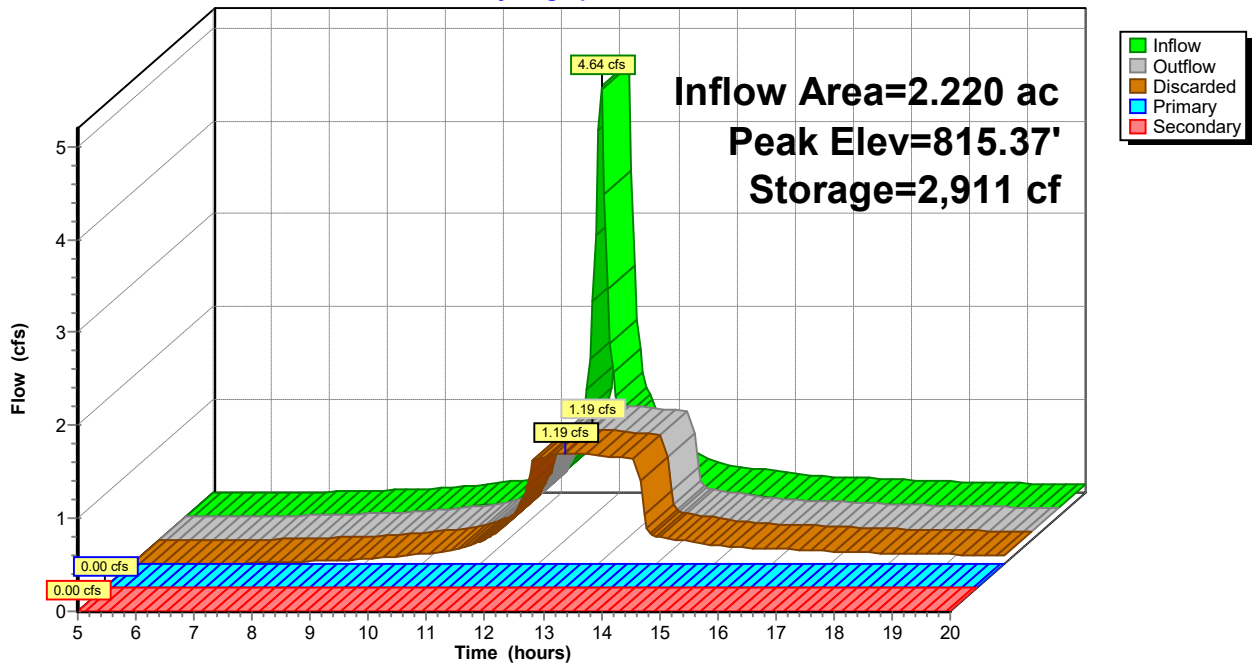

Summary for Pond 17P: DET 220

Inflow Area = 1.110 ac, 0.00% Impervious, Inflow Depth > 1.74" for 2-Year event
 Inflow = 2.36 cfs @ 12.13 hrs, Volume= 0.161 af
 Outflow = 0.31 cfs @ 12.89 hrs, Volume= 0.161 af, Atten= 87%, Lag= 45.8 min
 Discarded = 0.31 cfs @ 12.89 hrs, Volume= 0.161 af
 Primary = 0.00 cfs @ 5.00 hrs, Volume= 0.000 af
 Routed to Link 18L : PR POA / B
 Secondary = 0.00 cfs @ 5.00 hrs, Volume= 0.000 af
 Routed to Link 18L : PR POA / B

Routing by Stor-Ind method, Time Span= 5.00-20.00 hrs, dt= 0.05 hrs
 Peak Elev= 801.86' @ 12.89 hrs Surf.Area= 1,951 sf Storage= 2,605 cf

Plug-Flow detention time= 81.3 min calculated for 0.161 af (100% of inflow)
 Center-of-Mass det. time= 80.6 min (864.4 - 783.8)

Volume	Invert	Avail.Storage	Storage Description		
#1	800.00'	8,875 cf	Custom Stage Data (Conic) Listed below (Recalc)		
Elevation (feet)	Surf.Area (sq-ft)	Inc.Store (cubic-feet)	Cum.Store (cubic-feet)	Wet.Area (sq-ft)	
800.00	879	0	0	879	
801.00	1,441	1,148	1,148	1,454	
802.00	2,039	1,731	2,880	2,070	
803.00	2,810	2,414	5,294	2,860	
804.00	4,412	3,581	8,875	4,476	

Device	Routing	Invert	Outlet Devices
#1	Discarded	800.00'	6.900 in/hr Exfiltration over Surface area
#2	Primary	800.50'	15.0" Round Culvert L= 39.0' CPP, projecting, no headwall, Ke= 0.900 Inlet / Outlet Invert= 800.50' / 800.00' S= 0.0128 '/' Cc= 0.900 n= 0.012, Flow Area= 1.23 sf
#3	Device 2	802.00'	6.0" Vert. Orifice/Grate C= 0.600 Limited to weir flow at low heads
#4	Device 2	802.60'	14.0' long Sharp-Crested Rectangular Weir 2 End Contraction(s)
#5	Secondary	803.00'	10.0' long + 3.0 ' SideZ x 8.0' breadth Broad-Crested Rectangular Weir Head (feet) 0.20 0.40 0.60 0.80 1.00 1.20 1.40 1.60 1.80 2.00 2.50 3.00 3.50 4.00 4.50 5.00 5.50 Coef. (English) 2.43 2.54 2.70 2.69 2.68 2.68 2.66 2.64 2.64 2.64 2.65 2.65 2.66 2.66 2.68 2.70 2.74

Discarded OutFlow Max=0.31 cfs @ 12.89 hrs HW=801.86' (Free Discharge)
 ↑1=Exfiltration (Exfiltration Controls 0.31 cfs)

Primary OutFlow Max=0.00 cfs @ 5.00 hrs HW=800.00' (Free Discharge)
 ↑2=Culvert (Controls 0.00 cfs)
 ↑3=Orifice/Grate (Controls 0.00 cfs)
 ↑4=Sharp-Crested Rectangular Weir (Controls 0.00 cfs)

Secondary OutFlow Max=0.00 cfs @ 5.00 hrs HW=800.00' (Free Discharge)
 ↑5=Broad-Crested Rectangular Weir (Controls 0.00 cfs)

Pond 17P: DET 220

Hydrograph

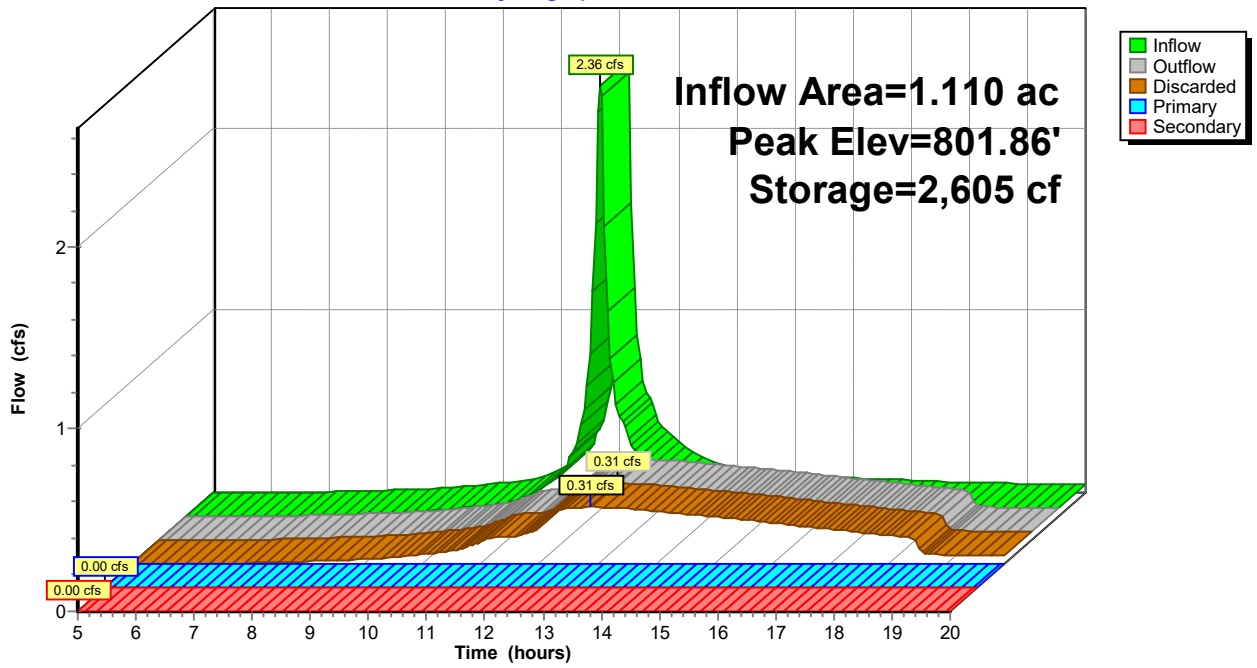

Summary for Pond 19P: PLUNGE POOL 120

Inflow Area = 0.990 ac, 0.00% Impervious, Inflow Depth > 0.60" for 2-Year event
 Inflow = 0.22 cfs @ 12.92 hrs, Volume= 0.049 af
 Outflow = 0.26 cfs @ 13.07 hrs, Volume= 0.039 af, Atten= 0%, Lag= 8.8 min
 Discarded = 0.02 cfs @ 13.05 hrs, Volume= 0.009 af
 Primary = 0.25 cfs @ 13.07 hrs, Volume= 0.029 af
 Routed to Link 15L : PR POA / A

Routing by Stor-Ind method, Time Span= 5.00-20.00 hrs, dt= 0.05 hrs
 Peak Elev= 815.02' @ 13.05 hrs Surf.Area= 756 sf Storage= 499 cf

Plug-Flow detention time= 75.4 min calculated for 0.038 af (78% of inflow)
 Center-of-Mass det. time= 32.2 min (888.6 - 856.3)

Volume	Invert	Avail.Storage	Storage Description
#1	814.00'	1,517 cf	Custom Stage Data (Prismatic) Listed below (Recalc)
Elevation (feet)	Surf.Area (sq-ft)	Inc.Store (cubic-feet)	Cum.Store (cubic-feet)
814.00	223	0	0
815.00	744	484	484
816.00	1,322	1,033	1,517

Device	Routing	Invert	Outlet Devices
#1	Discarded	814.00'	0.860 in/hr Exfiltration over Surface area
#2	Primary	815.00'	30.0' long + 3.0 ' SideZ x 8.0' breadth Broad-Crested Rectangular Weir
Head (feet) 0.20 0.40 0.60 0.80 1.00 1.20 1.40 1.60 1.80			
2.00 2.50 3.00 3.50 4.00 4.50 5.00 5.50			
Coef. (English) 2.43 2.54 2.70 2.69 2.68 2.68 2.66 2.64 2.64			
2.64 2.65 2.65 2.66 2.66 2.68 2.70 2.74			

Discarded OutFlow Max=0.02 cfs @ 13.05 hrs HW=815.02' (Free Discharge)
 ↑1=Exfiltration (Exfiltration Controls 0.02 cfs)

Primary OutFlow Max=0.21 cfs @ 13.07 hrs HW=815.02' (Free Discharge)
 ↑2=Broad-Crested Rectangular Weir (Weir Controls 0.21 cfs @ 0.35 fps)

Pond 19P: PLUNGE POOL 120

Hydrograph

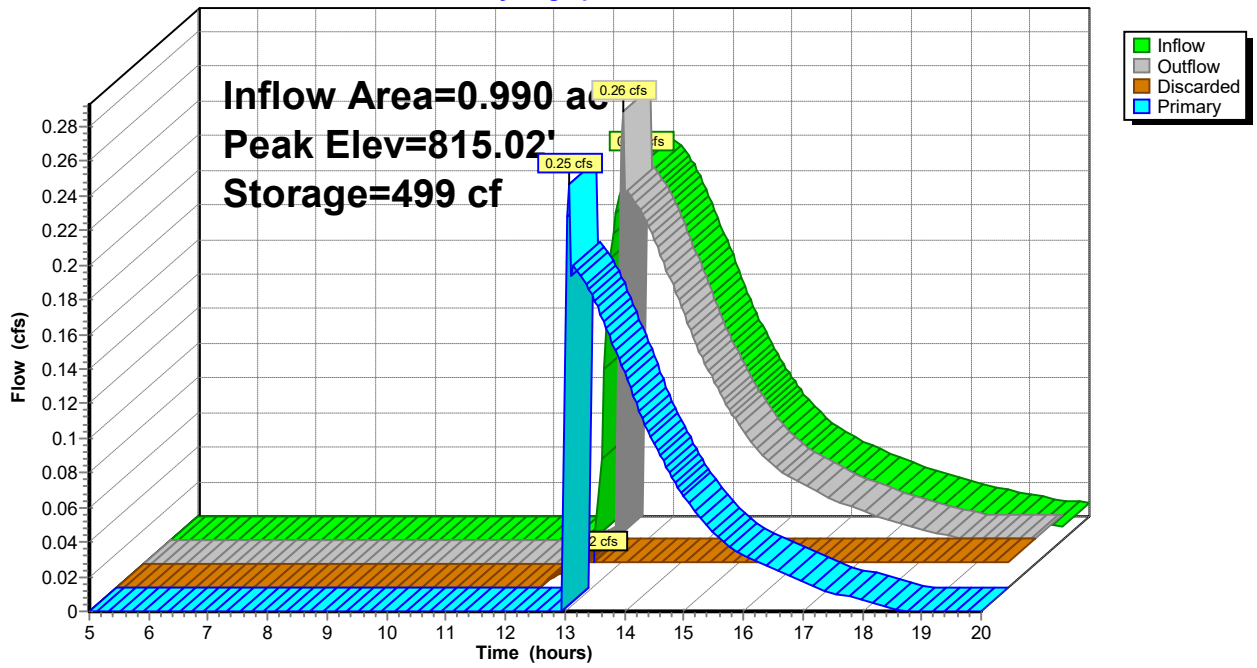

Summary for Link 4L: EX POA / A

Inflow Area = 18.510 ac, 0.00% Impervious, Inflow Depth > 0.77" for 2-Year event
Inflow = 7.53 cfs @ 12.57 hrs, Volume= 1.190 af
Primary = 7.53 cfs @ 12.57 hrs, Volume= 1.190 af, Atten= 0%, Lag= 0.0 min

Primary outflow = Inflow, Time Span= 5.00-20.00 hrs, dt= 0.05 hrs

Link 4L: EX POA / A

Hydrograph

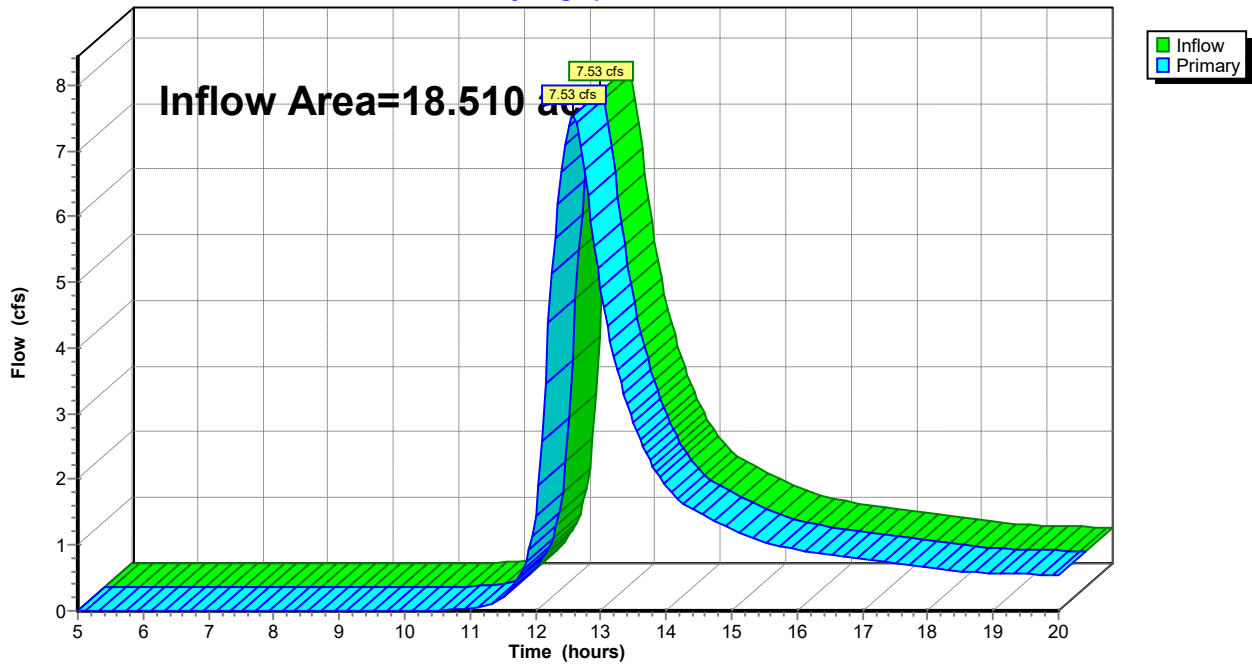

Summary for Link 15L: PR POA / A

Inflow Area = 17.680 ac, 0.00% Impervious, Inflow Depth > 0.79" for 2-Year event
Inflow = 7.30 cfs @ 12.58 hrs, Volume= 1.167 af
Primary = 7.30 cfs @ 12.58 hrs, Volume= 1.167 af, Atten= 0%, Lag= 0.0 min

Primary outflow = Inflow, Time Span= 5.00-20.00 hrs, dt= 0.05 hrs

Link 15L: PR POA / A

Hydrograph

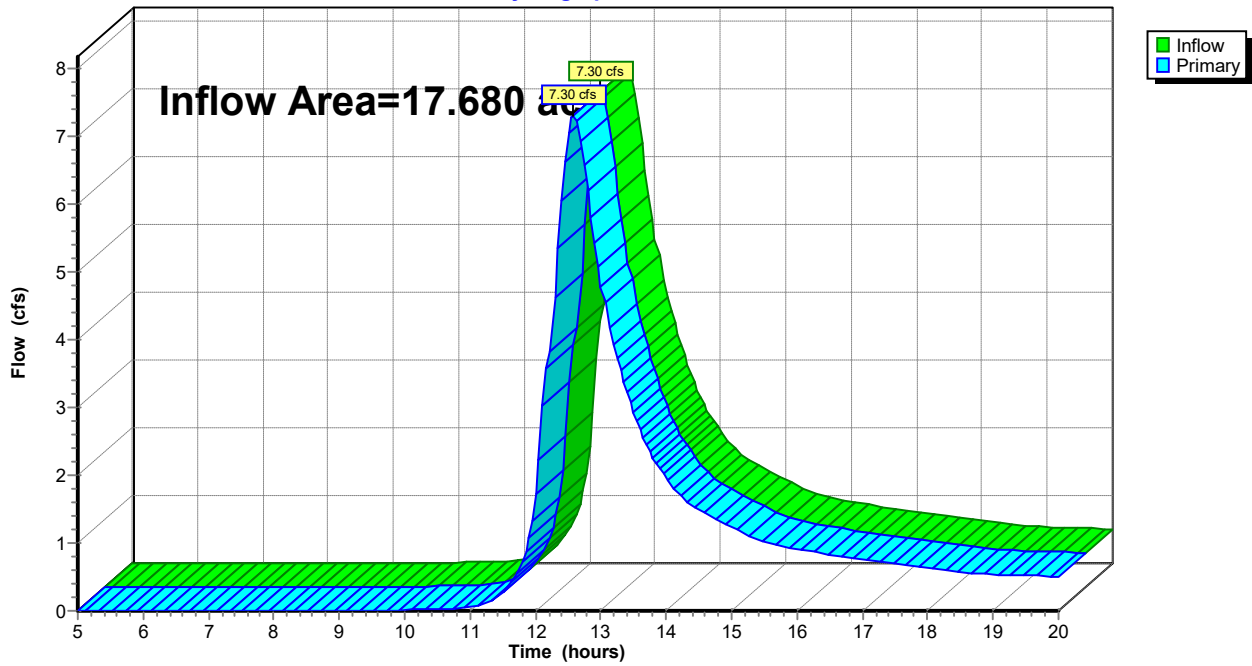

Summary for Link 18L: PR POA / B

Inflow Area = 6.280 ac, 0.00% Impervious, Inflow Depth > 0.61" for 2-Year event
Inflow = 3.58 cfs @ 12.24 hrs, Volume= 0.321 af
Primary = 3.58 cfs @ 12.24 hrs, Volume= 0.321 af, Atten= 0%, Lag= 0.0 min

Primary outflow = Inflow, Time Span= 5.00-20.00 hrs, dt= 0.05 hrs

Link 18L: PR POA / B

Hydrograph

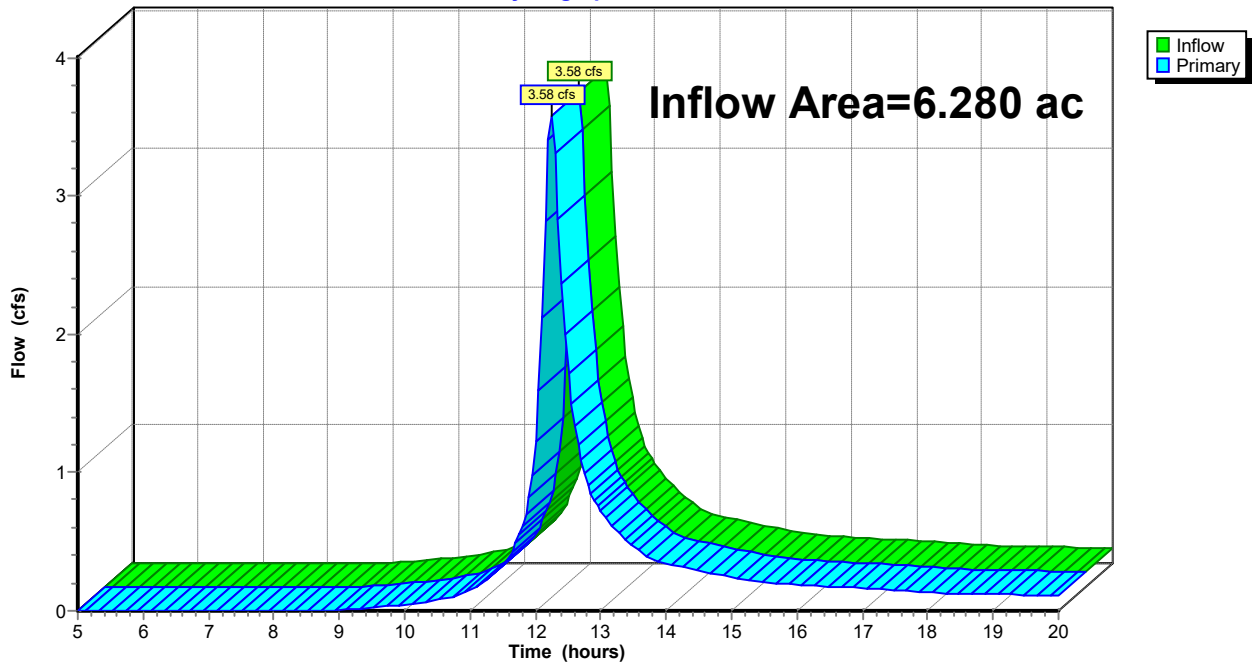

Summary for Subcatchment 1S: EXWS-10

Runoff = 5.62 cfs @ 12.23 hrs, Volume= 0.491 af, Depth> 2.39"
 Routed to Link 4L : EX POA / A

Runoff by SCS TR-20 method, UH=SCS, Weighted-CN, Time Span= 5.00-20.00 hrs, dt= 0.05 hrs
 NOAA 24-hr D 10-Year Rainfall=5.11"

Area (ac)	CN	Description
* 2.460	76	
2.460		100.00% Pervious Area

Tc (min)	Length (feet)	Slope (ft/ft)	Velocity (ft/sec)	Capacity (cfs)	Description
14.2					Direct Entry,

Subcatchment 1S: EXWS-10

Hydrograph

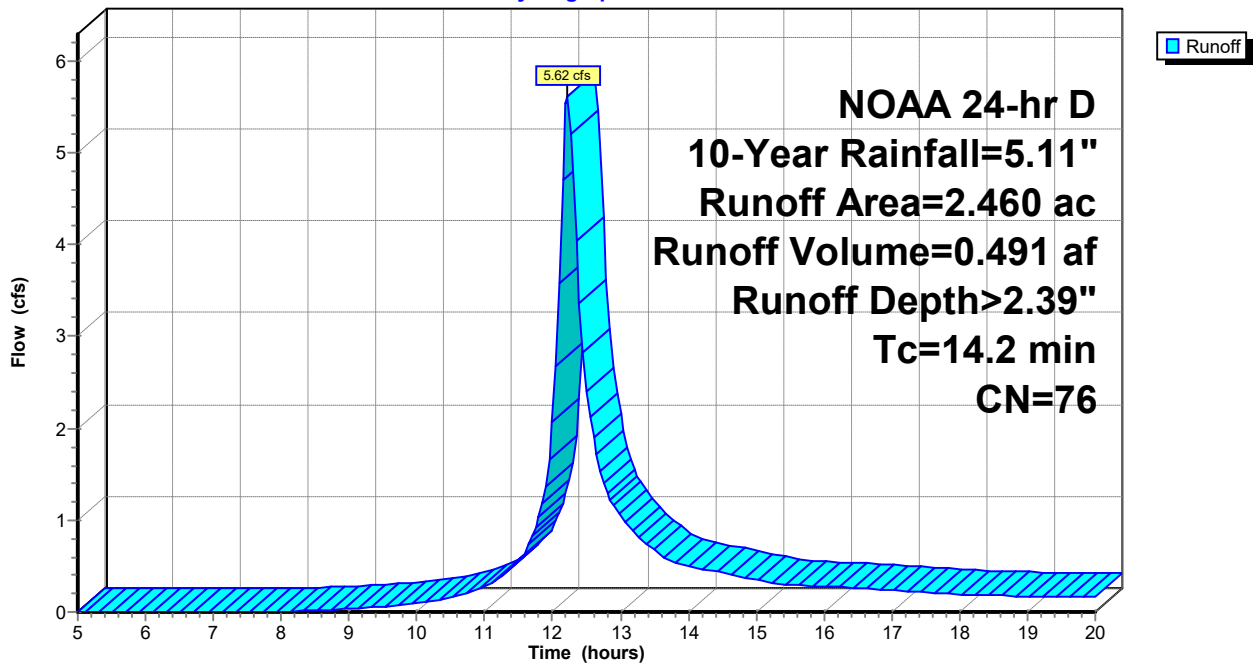

Summary for Subcatchment 2S: EXWS-11

Runoff = 19.42 cfs @ 12.56 hrs, Volume= 2.730 af, Depth> 2.04"
 Routed to Link 4L : EX POA / A

Runoff by SCS TR-20 method, UH=SCS, Weighted-CN, Time Span= 5.00-20.00 hrs, dt= 0.05 hrs
 NOAA 24-hr D 10-Year Rainfall=5.11"

Area (ac)	CN	Description
* 16.050	72	
16.050		100.00% Pervious Area

Tc (min)	Length (feet)	Slope (ft/ft)	Velocity (ft/sec)	Capacity (cfs)	Description
39.6					Direct Entry,

Subcatchment 2S: EXWS-11

Hydrograph

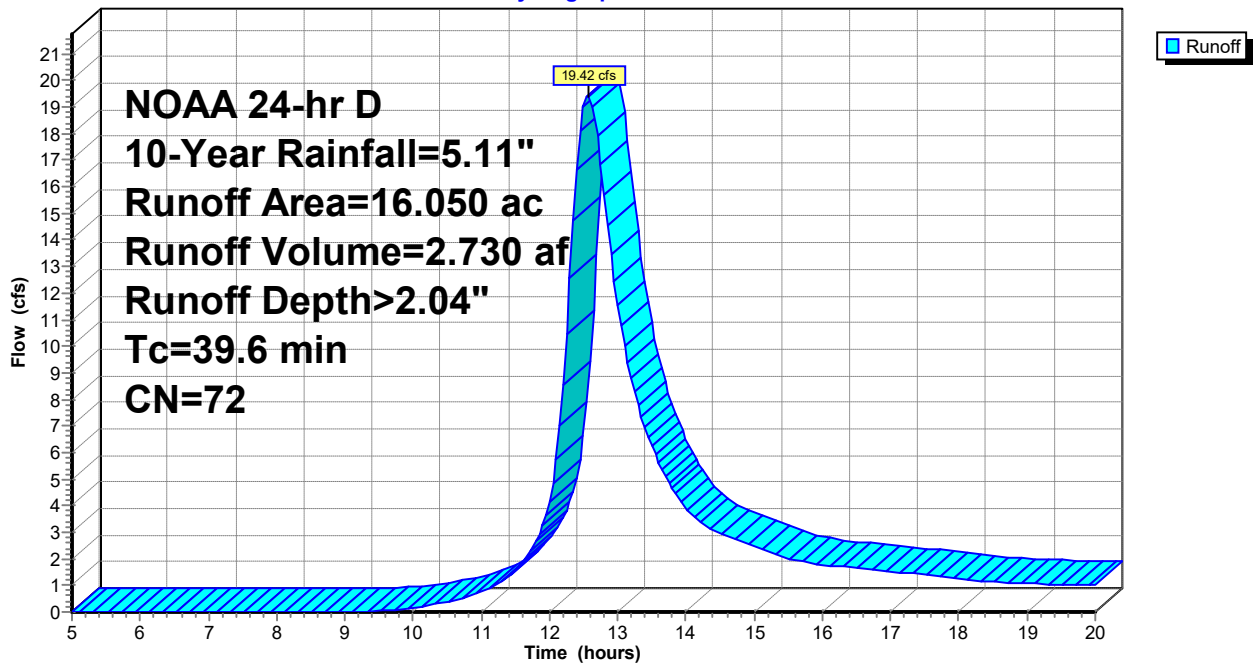

Summary for Subcatchment 5S: EXWS-20 / B

Runoff = 13.11 cfs @ 12.23 hrs, Volume= 1.180 af, Depth> 2.83"

Runoff by SCS TR-20 method, UH=SCS, Weighted-CN, Time Span= 5.00-20.00 hrs, dt= 0.05 hrs
 NOAA 24-hr D 10-Year Rainfall=5.11"

Area (ac)	CN	Description
* 5.000	81	
5.000		100.00% Pervious Area

Tc (min)	Length (feet)	Slope (ft/ft)	Velocity (ft/sec)	Capacity (cfs)	Description
14.9					Direct Entry,

Subcatchment 5S: EXWS-20 / B

Hydrograph

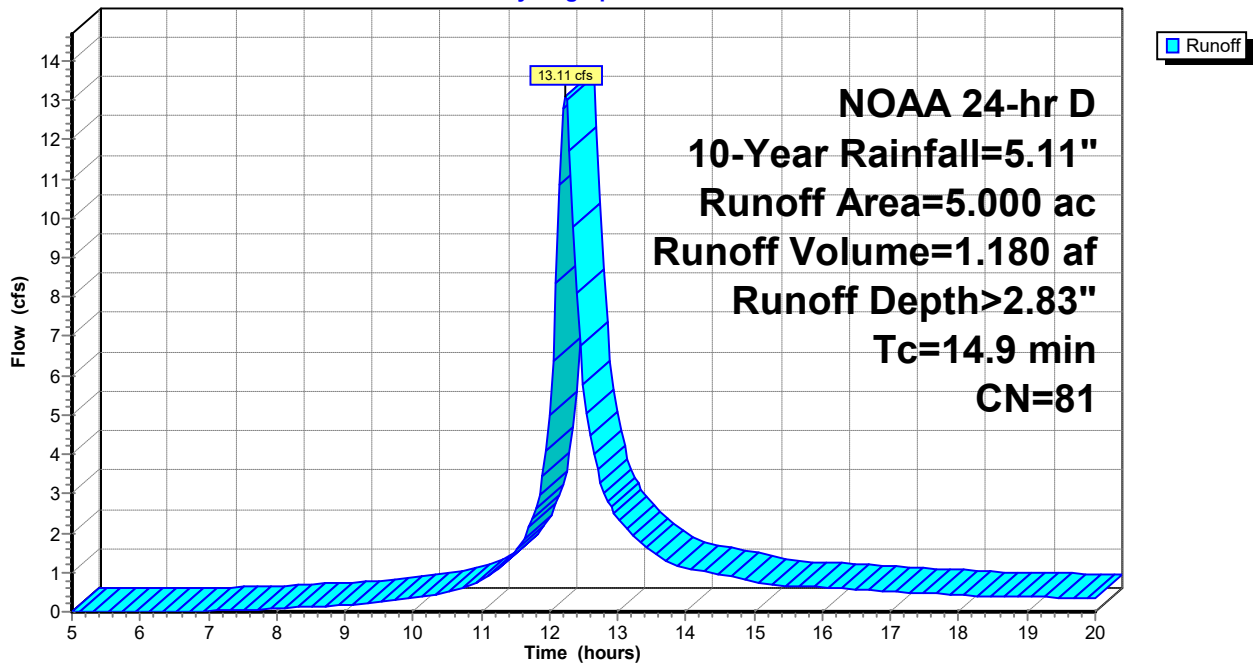

Summary for Subcatchment 6S: EXWS-30 / C

Runoff = 4.00 cfs @ 12.22 hrs, Volume= 0.345 af, Depth> 2.48"

Runoff by SCS TR-20 method, UH=SCS, Weighted-CN, Time Span= 5.00-20.00 hrs, dt= 0.05 hrs
NOAA 24-hr D 10-Year Rainfall=5.11"

Area (ac)	CN	Description
* 1.670	77	
1.670		100.00% Pervious Area

Tc (min)	Length (feet)	Slope (ft/ft)	Velocity (ft/sec)	Capacity (cfs)	Description
14.0					Direct Entry,

Subcatchment 6S: EXWS-30 / C

Hydrograph

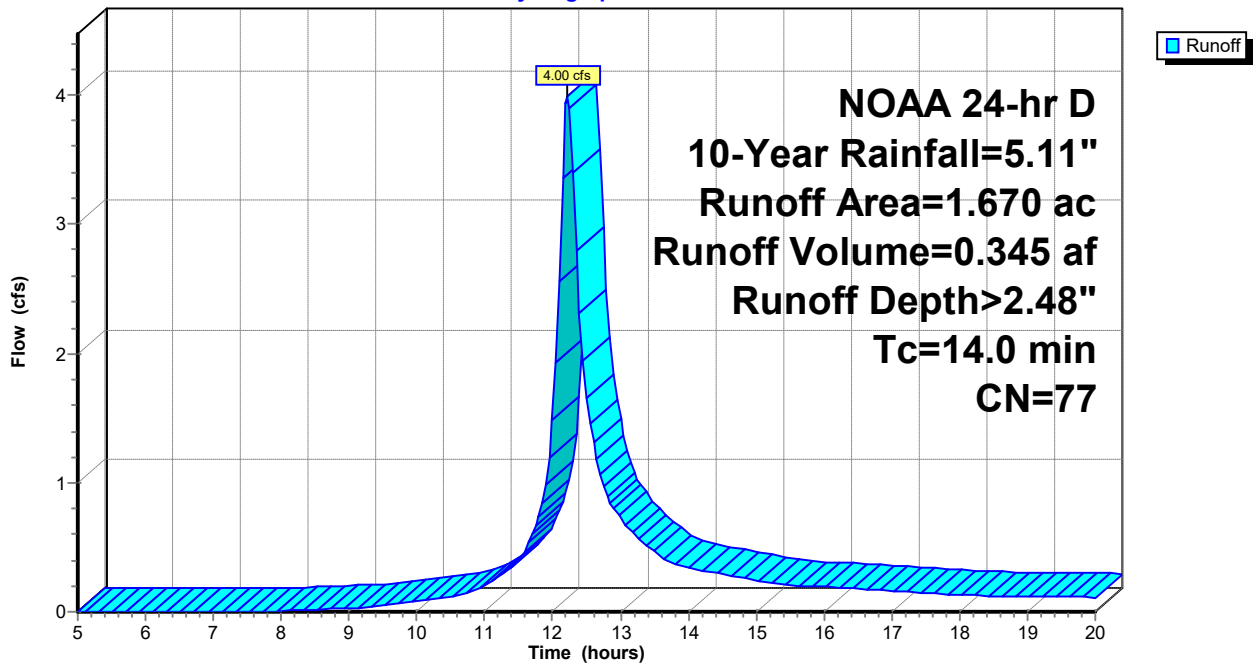

Summary for Subcatchment 7S: PRWS-10

Runoff = 3.92 cfs @ 12.13 hrs, Volume= 0.266 af, Depth> 2.75"
 Routed to Link 15L : PR POA / A

Runoff by SCS TR-20 method, UH=SCS, Weighted-CN, Time Span= 5.00-20.00 hrs, dt= 0.05 hrs
 NOAA 24-hr D 10-Year Rainfall=5.11"

Area (ac)	CN	Description
* 1.160	80	
1.160		100.00% Pervious Area

Tc (min)	Length (feet)	Slope (ft/ft)	Velocity (ft/sec)	Capacity (cfs)	Description
6.0					Direct Entry,

Subcatchment 7S: PRWS-10

Hydrograph

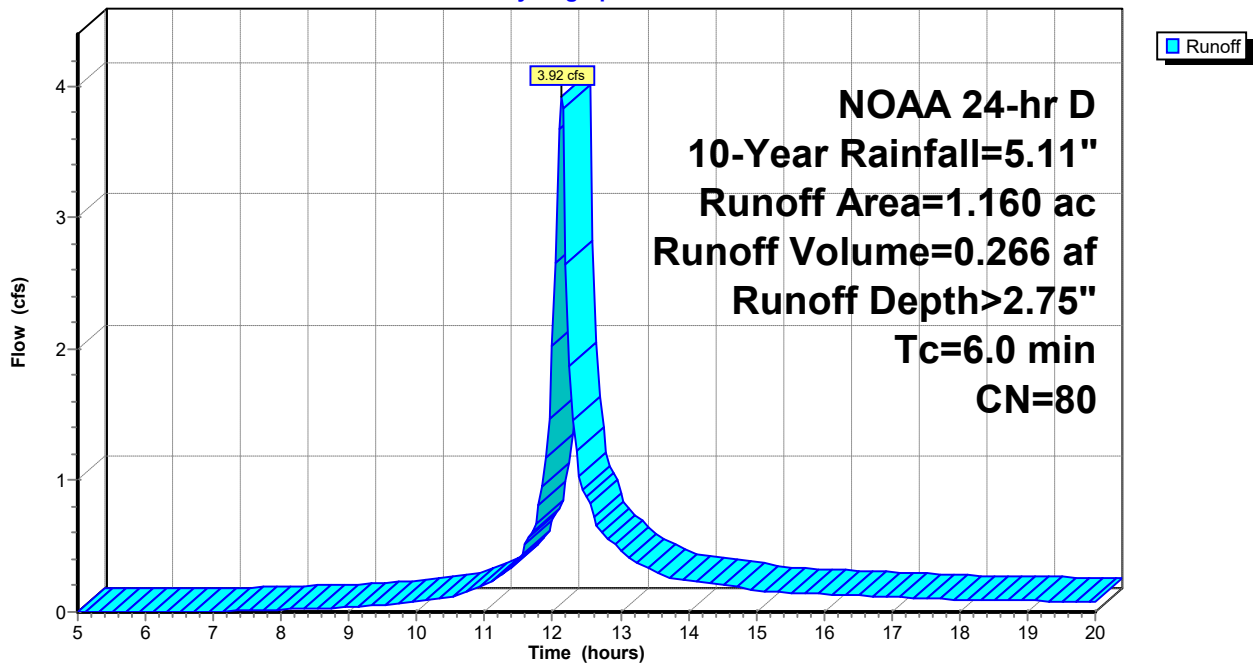

Summary for Subcatchment 8S: PRWS-11

Runoff = 19.54 cfs @ 12.56 hrs, Volume= 2.744 af, Depth> 2.12"
 Routed to Link 15L : PR POA / A

Runoff by SCS TR-20 method, UH=SCS, Weighted-CN, Time Span= 5.00-20.00 hrs, dt= 0.05 hrs
 NOAA 24-hr D 10-Year Rainfall=5.11"

Area (ac)	CN	Description
* 15.530	73	
15.530		100.00% Pervious Area

Tc (min)	Length (feet)	Slope (ft/ft)	Velocity (ft/sec)	Capacity (cfs)	Description
39.6					Direct Entry,

Subcatchment 8S: PRWS-11

Hydrograph

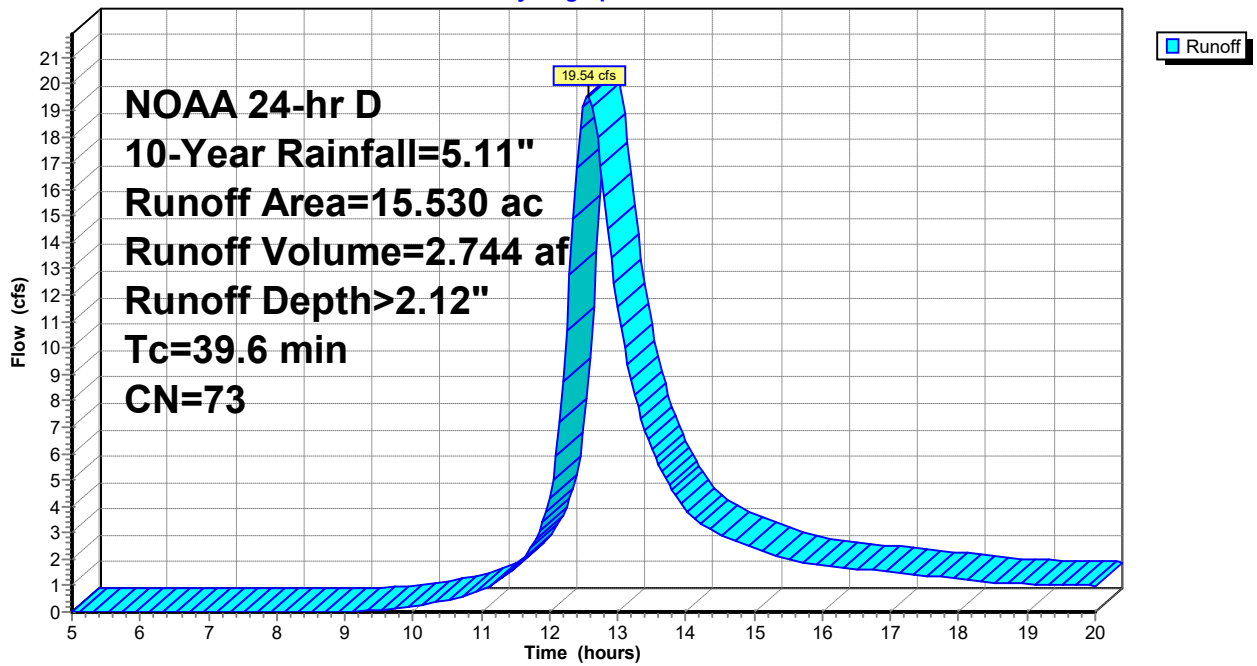

Summary for Subcatchment 9S: PRWS-12

Runoff = 3.90 cfs @ 12.13 hrs, Volume= 0.273 af, Depth> 3.31"
 Routed to Pond 14P : UG 120

Runoff by SCS TR-20 method, UH=SCS, Weighted-CN, Time Span= 5.00-20.00 hrs, dt= 0.05 hrs
 NOAA 24-hr D 10-Year Rainfall=5.11"

Area (ac)	CN	Description
* 0.990	86	
0.990		100.00% Pervious Area

Tc (min)	Length (feet)	Slope (ft/ft)	Velocity (ft/sec)	Capacity (cfs)	Description
6.0					Direct Entry,

Subcatchment 9S: PRWS-12

Hydrograph

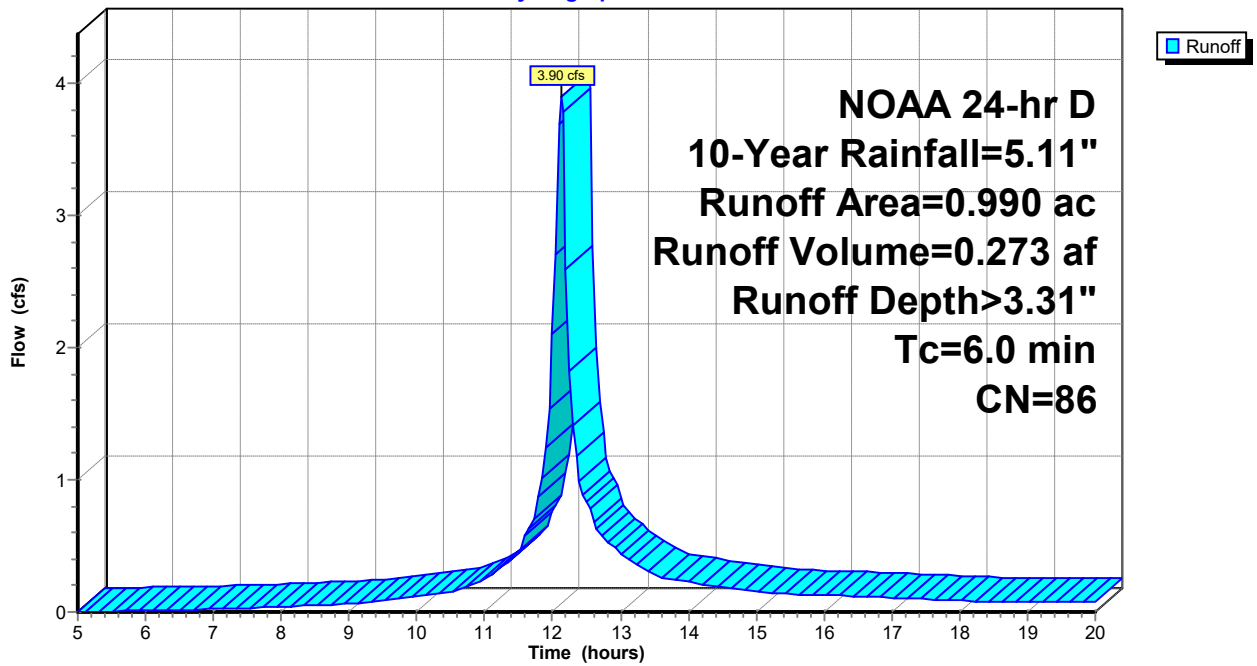

Summary for Subcatchment 10S: PRWS-20

Runoff = 7.87 cfs @ 12.24 hrs, Volume= 0.719 af, Depth> 2.92"
 Routed to Link 18L : PR POA / B

Runoff by SCS TR-20 method, UH=SCS, Weighted-CN, Time Span= 5.00-20.00 hrs, dt= 0.05 hrs
 NOAA 24-hr D 10-Year Rainfall=5.11"

Area (ac)	CN	Description
* 2.950	82	
2.950		100.00% Pervious Area

Tc (min)	Length (feet)	Slope (ft/ft)	Velocity (ft/sec)	Capacity (cfs)	Description
15.4					Direct Entry,

Subcatchment 10S: PRWS-20

Hydrograph

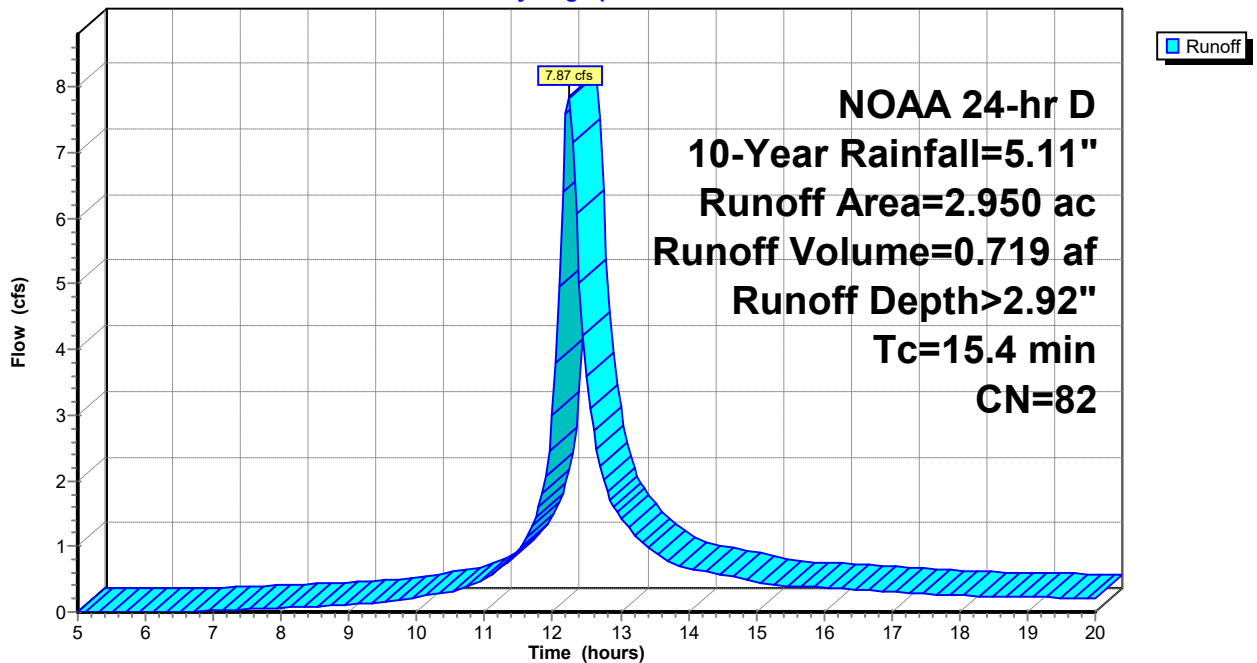

Summary for Subcatchment 11S: PRWS-21

Runoff = 8.98 cfs @ 12.14 hrs, Volume= 0.649 af, Depth> 3.51"
 Routed to Pond 16P : DET 210

Runoff by SCS TR-20 method, UH=SCS, Weighted-CN, Time Span= 5.00-20.00 hrs, dt= 0.05 hrs
 NOAA 24-hr D 10-Year Rainfall=5.11"

Area (ac)	CN	Description
* 2.220	88	
2.220		100.00% Pervious Area

Tc (min)	Length (feet)	Slope (ft/ft)	Velocity (ft/sec)	Capacity (cfs)	Description
6.8					Direct Entry,

Subcatchment 11S: PRWS-21

Hydrograph

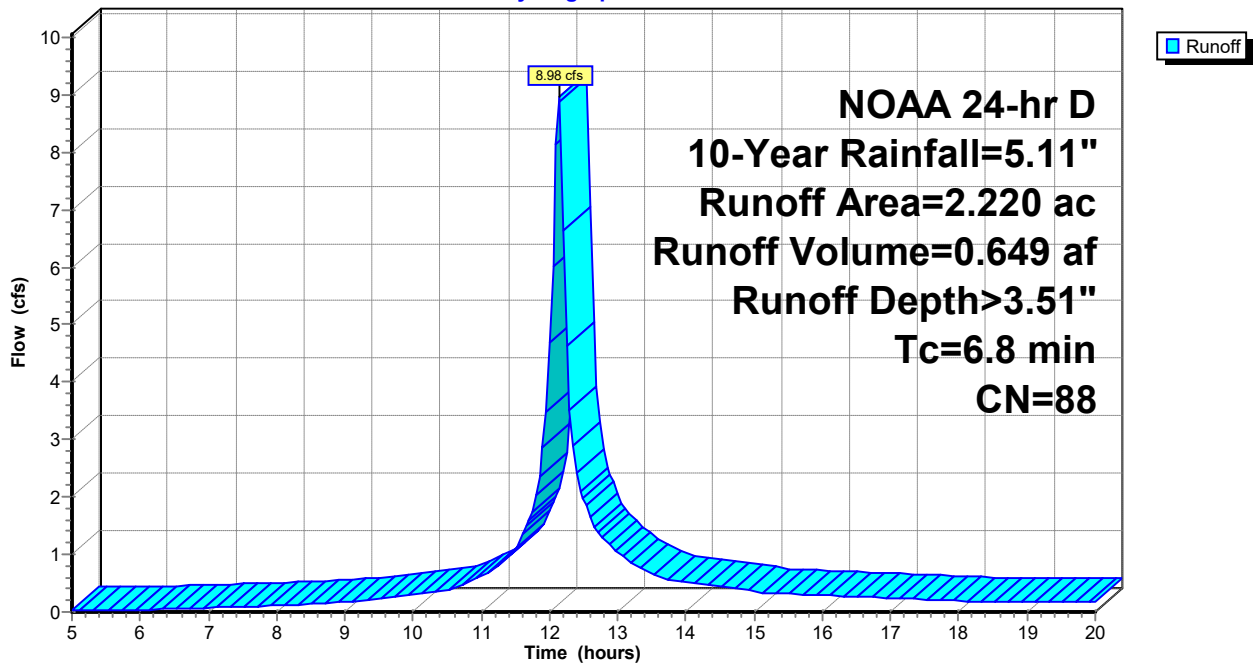

Summary for Subcatchment 12S: PRWS-22

Runoff = 4.57 cfs @ 12.13 hrs, Volume= 0.325 af, Depth> 3.51"
 Routed to Pond 17P : DET 220

Runoff by SCS TR-20 method, UH=SCS, Weighted-CN, Time Span= 5.00-20.00 hrs, dt= 0.05 hrs
 NOAA 24-hr D 10-Year Rainfall=5.11"

Area (ac)	CN	Description
* 1.110	88	
1.110		100.00% Pervious Area

Tc (min)	Length (feet)	Slope (ft/ft)	Velocity (ft/sec)	Capacity (cfs)	Description
6.0					Direct Entry,

Subcatchment 12S: PRWS-22

Hydrograph

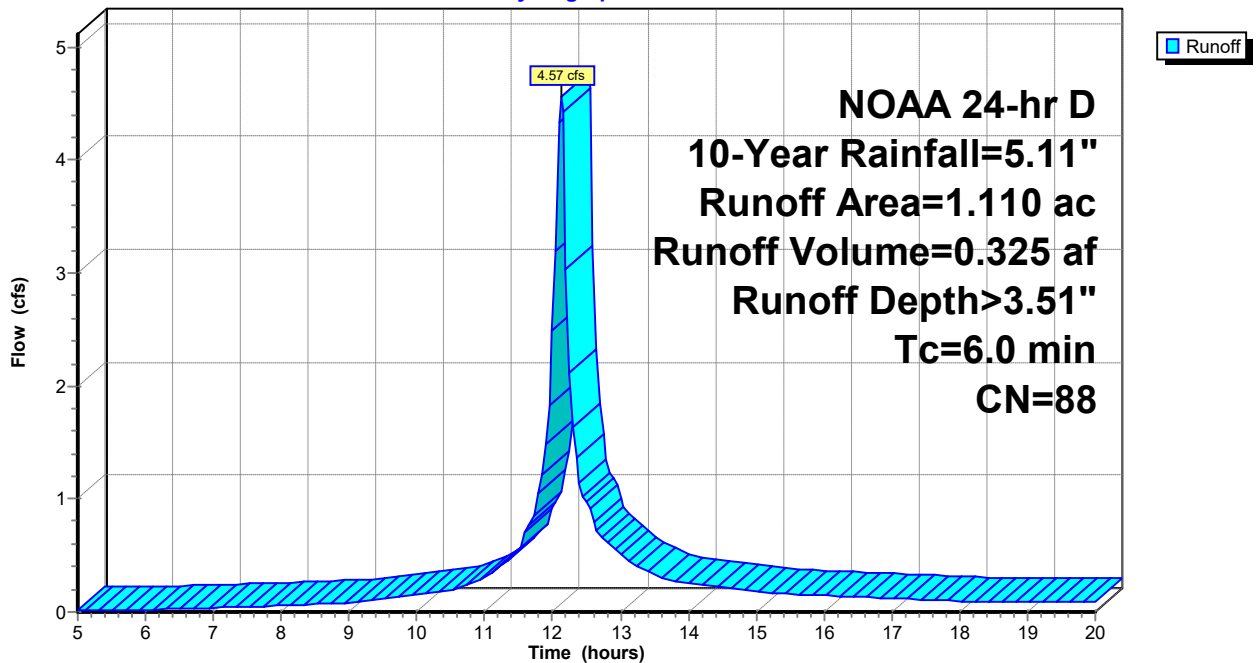

Summary for Subcatchment 13S: PRWS-30 / C

Runoff = 3.42 cfs @ 12.21 hrs, Volume= 0.292 af, Depth> 2.65"

Runoff by SCS TR-20 method, UH=SCS, Weighted-CN, Time Span= 5.00-20.00 hrs, dt= 0.05 hrs
 NOAA 24-hr D 10-Year Rainfall=5.11"

Area (ac)	CN	Description
* 1.320	79	
1.320		100.00% Pervious Area

Tc (min)	Length (feet)	Slope (ft/ft)	Velocity (ft/sec)	Capacity (cfs)	Description
13.4					Direct Entry,

Subcatchment 13S: PRWS-30 / C

Hydrograph

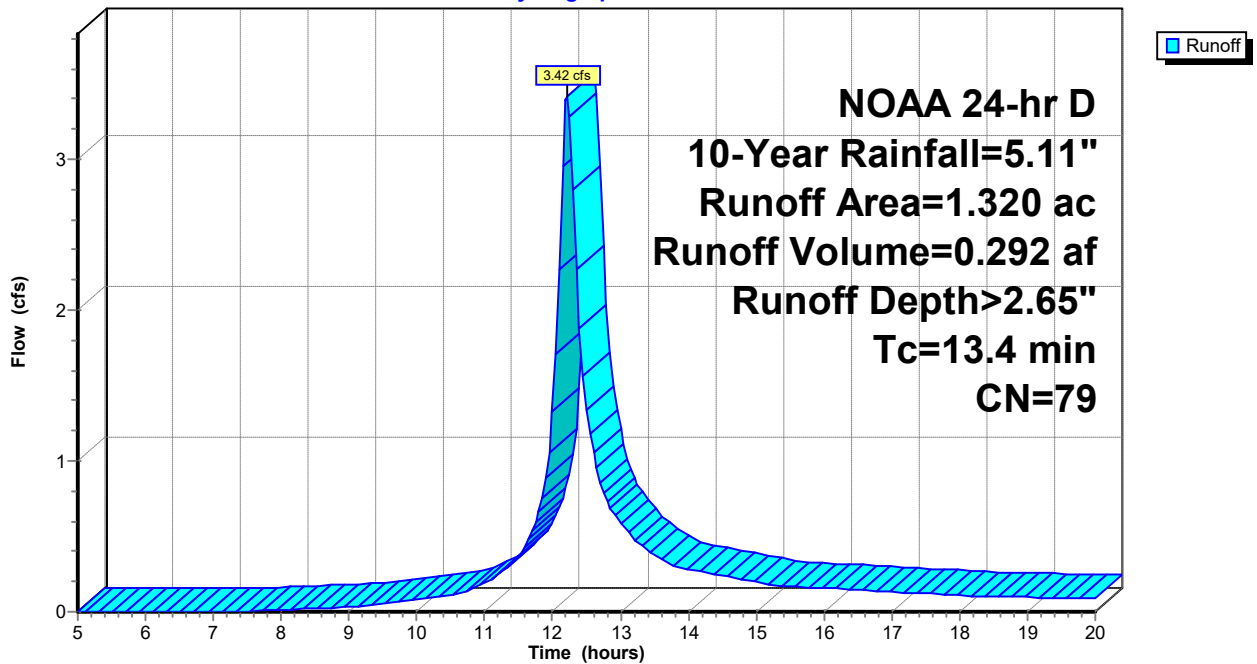

Summary for Pond 14P: UG 120

Inflow Area = 0.990 ac, 0.00% Impervious, Inflow Depth > 3.31" for 10-Year event
 Inflow = 3.90 cfs @ 12.13 hrs, Volume= 0.273 af
 Outflow = 1.14 cfs @ 12.37 hrs, Volume= 0.222 af, Atten= 71%, Lag= 14.4 min
 Discarded = 0.04 cfs @ 8.40 hrs, Volume= 0.041 af
 Primary = 1.10 cfs @ 12.37 hrs, Volume= 0.181 af
 Routed to Pond 19P : PLUNGE POOL 120

Routing by Stor-Ind method, Time Span= 5.00-20.00 hrs, dt= 0.05 hrs
 Peak Elev= 818.12' @ 12.37 hrs Surf.Area= 0.044 ac Storage= 0.121 af

Plug-Flow detention time= 128.1 min calculated for 0.222 af (81% of inflow)
 Center-of-Mass det. time= 74.3 min (846.0 - 771.7)

Volume	Invert	Avail.Storage	Storage Description
#1A	815.00'	0.000 af	24.00'W x 80.00'L x 4.67'H Field A 0.206 af Overall - 0.206 af Embedded = 0.000 af x 40.0% Voids
#2A	815.00'	0.155 af	retain_it retain_it 4.0' x 30 Inside #1 Inside= 84.0"W x 48.0"H => 28.87 sf x 8.00'L = 230.9 cf Outside= 96.0"W x 56.0"H => 37.33 sf x 8.00'L = 298.7 cf 3 Rows adjusted for 196.3 cf perimeter wall
		0.155 af	Total Available Storage

Storage Group A created with Chamber Wizard

Device	Routing	Invert	Outlet Devices
#1	Discarded	815.00'	0.860 in/hr Exfiltration over Surface area
#2	Primary	815.00'	12.0" Round Culvert L= 30.0' CPP, projecting, no headwall, Ke= 0.900 Inlet / Outlet Invert= 815.00' / 814.00' S= 0.0333 '/' Cc= 0.900 n= 0.012, Flow Area= 0.79 sf
#3	Device 2	816.20'	4.0" Vert. Orifice/Grate C= 0.600 Limited to weir flow at low heads
#4	Device 2	818.00'	3.9' long Sharp-Crested Rectangular Weir 2 End Contraction(s)

Discarded OutFlow Max=0.04 cfs @ 8.40 hrs HW=815.05' (Free Discharge)
 ↳ **1=Exfiltration** (Exfiltration Controls 0.04 cfs)

Primary OutFlow Max=1.08 cfs @ 12.37 hrs HW=818.12' (Free Discharge)
 ↳ **2=Culvert** (Passes 1.08 cfs of 4.83 cfs potential flow)
 ↳ **3=Orifice/Grate** (Orifice Controls 0.56 cfs @ 6.37 fps)
 ↳ **4=Sharp-Crested Rectangular Weir** (Weir Controls 0.52 cfs @ 1.13 fps)

Pond 14P: UG 120

Hydrograph

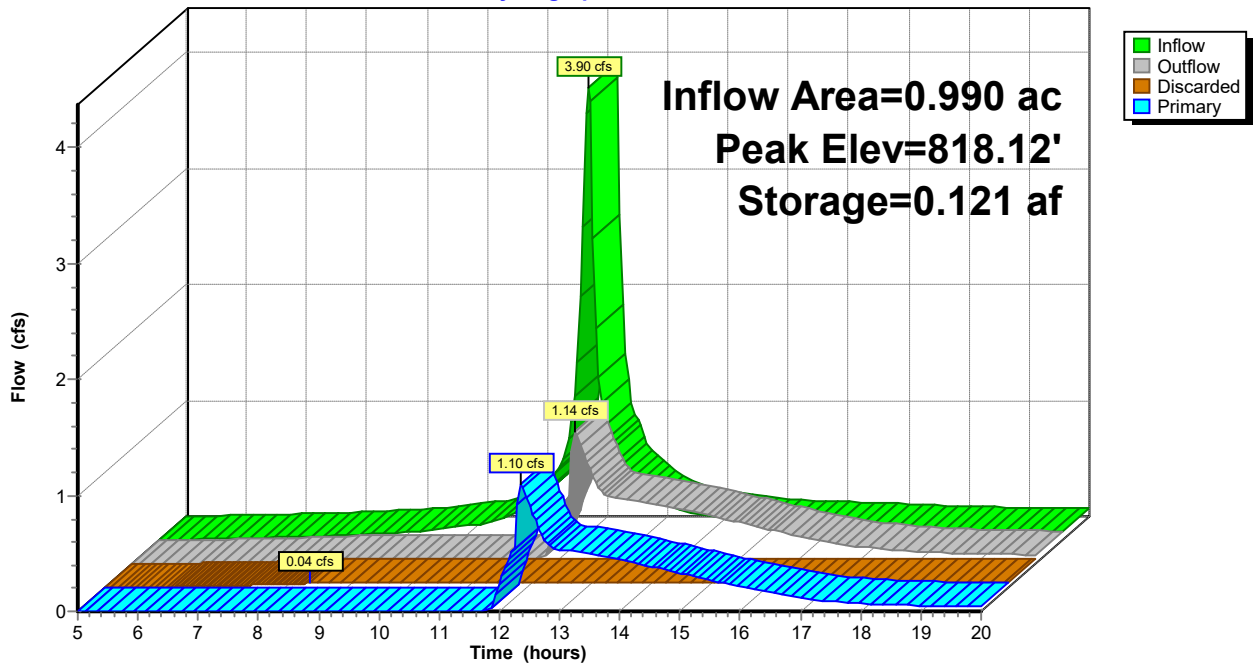

Summary for Pond 16P: DET 210

Inflow Area = 2.220 ac, 0.00% Impervious, Inflow Depth > 3.51" for 10-Year event
 Inflow = 8.98 cfs @ 12.14 hrs, Volume= 0.649 af
 Outflow = 1.68 cfs @ 12.59 hrs, Volume= 0.649 af, Atten= 81%, Lag= 27.4 min
 Discarded = 1.32 cfs @ 12.59 hrs, Volume= 0.618 af
 Primary = 0.36 cfs @ 12.59 hrs, Volume= 0.031 af
 Routed to Link 18L : PR POA / B
 Secondary = 0.00 cfs @ 5.00 hrs, Volume= 0.000 af
 Routed to Link 18L : PR POA / B

Routing by Stor-Ind method, Time Span= 5.00-20.00 hrs, dt= 0.05 hrs
 Peak Elev= 816.00' @ 12.59 hrs Surf.Area= 8,902 sf Storage= 8,170 cf

Plug-Flow detention time= 40.4 min calculated for 0.649 af (100% of inflow)
 Center-of-Mass det. time= 39.9 min (806.4 - 766.5)

Volume	Invert	Avail.Storage	Storage Description		
#1	815.00'	28,806 cf	Custom Stage Data (Conic) Listed below (Recalc)		
Elevation (feet)	Surf.Area (sq-ft)	Inc.Store (cubic-feet)	Cum.Store (cubic-feet)	Wet.Area (sq-ft)	
815.00	7,517	0	0	7,517	
816.00	8,907	8,202	8,202	8,944	
817.00	10,296	9,593	17,795	10,375	
818.00	11,741	11,011	28,806	11,867	

Device	Routing	Invert	Outlet Devices
#1	Discarded	815.00'	6.400 in/hr Exfiltration over Surface area
#2	Primary	815.00'	12.0" Round Culvert L= 127.0' CPP, projecting, no headwall, Ke= 0.900 Inlet / Outlet Invert= 815.00' / 806.40' S= 0.0677 '/' Cc= 0.900 n= 0.012, Flow Area= 0.79 sf
#3	Device 2	815.60'	6.0" Vert. Orifice/Grate C= 0.600 Limited to weir flow at low heads
#4	Device 2	816.80'	14.0' long Sharp-Crested Rectangular Weir 2 End Contraction(s)
#5	Secondary	817.00'	10.0' long + 3.0 ' SideZ x 8.0' breadth Broad-Crested Rectangular Weir Head (feet) 0.20 0.40 0.60 0.80 1.00 1.20 1.40 1.60 1.80 2.00 2.50 3.00 3.50 4.00 4.50 5.00 5.50 Coef. (English) 2.43 2.54 2.70 2.69 2.68 2.68 2.66 2.64 2.64 2.64 2.65 2.65 2.66 2.66 2.68 2.70 2.74

Discarded OutFlow Max=1.32 cfs @ 12.59 hrs HW=816.00' (Free Discharge)
 ↑1=Exfiltration (Exfiltration Controls 1.32 cfs)

Primary OutFlow Max=0.36 cfs @ 12.59 hrs HW=816.00' (Free Discharge)
 ↑2=Culvert (Passes 0.36 cfs of 2.11 cfs potential flow)
 ↑3=Orifice/Grate (Orifice Controls 0.36 cfs @ 2.14 fps)
 ↑4=Sharp-Crested Rectangular Weir (Controls 0.00 cfs)

Secondary OutFlow Max=0.00 cfs @ 5.00 hrs HW=815.00' (Free Discharge)
 ↑5=Broad-Crested Rectangular Weir (Controls 0.00 cfs)

Pond 16P: DET 210

Hydrograph

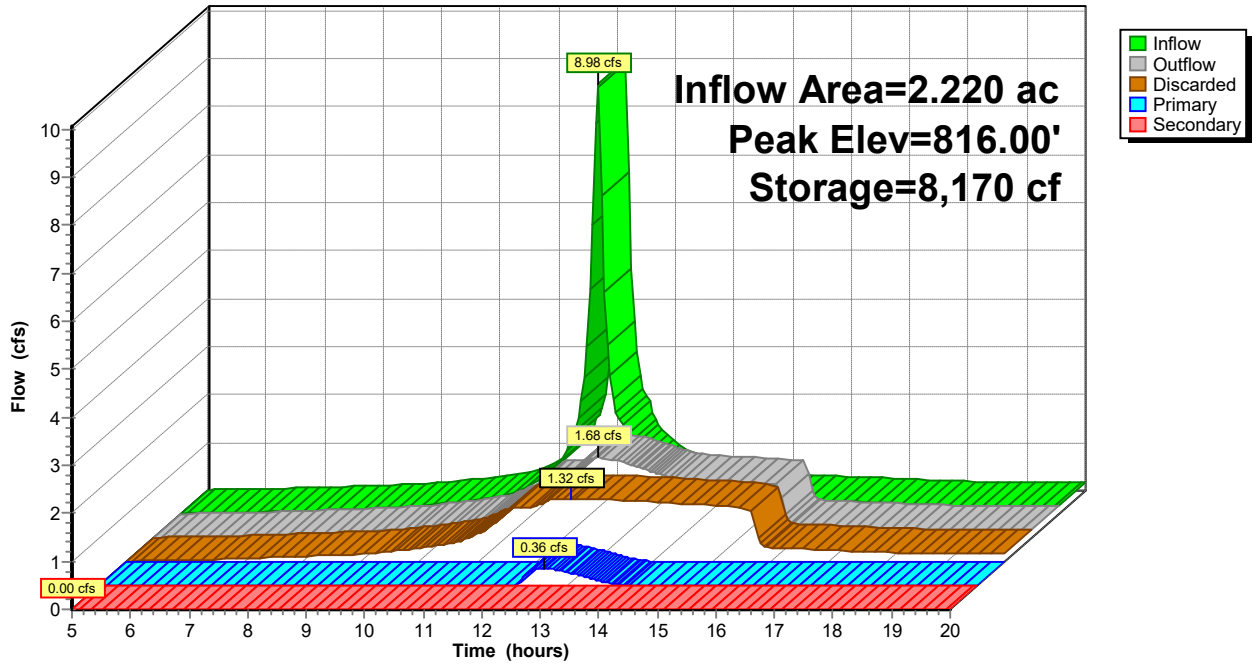

Summary for Pond 17P: DET 220

Inflow Area = 1.110 ac, 0.00% Impervious, Inflow Depth > 3.51" for 10-Year event
 Inflow = 4.57 cfs @ 12.13 hrs, Volume= 0.325 af
 Outflow = 2.44 cfs @ 12.25 hrs, Volume= 0.316 af, Atten= 47%, Lag= 7.5 min
 Discarded = 0.41 cfs @ 12.25 hrs, Volume= 0.241 af
 Primary = 2.03 cfs @ 12.25 hrs, Volume= 0.075 af
 Routed to Link 18L : PR POA / B
 Secondary = 0.00 cfs @ 5.00 hrs, Volume= 0.000 af
 Routed to Link 18L : PR POA / B

Routing by Stor-Ind method, Time Span= 5.00-20.00 hrs, dt= 0.05 hrs
 Peak Elev= 802.70' @ 12.25 hrs Surf.Area= 2,563 sf Storage= 4,480 cf

Plug-Flow detention time= 80.6 min calculated for 0.316 af (97% of inflow)
 Center-of-Mass det. time= 69.8 min (835.7 - 765.9)

Volume	Invert	Avail.Storage	Storage Description		
#1	800.00'	8,875 cf	Custom Stage Data (Conic) Listed below (Recalc)		
Elevation (feet)	Surf.Area (sq-ft)	Inc.Store (cubic-feet)	Cum.Store (cubic-feet)	Wet.Area (sq-ft)	
800.00	879	0	0	879	
801.00	1,441	1,148	1,148	1,454	
802.00	2,039	1,731	2,880	2,070	
803.00	2,810	2,414	5,294	2,860	
804.00	4,412	3,581	8,875	4,476	

Device	Routing	Invert	Outlet Devices
#1	Discarded	800.00'	6.900 in/hr Exfiltration over Surface area
#2	Primary	800.50'	15.0" Round Culvert L= 39.0' CPP, projecting, no headwall, Ke= 0.900 Inlet / Outlet Invert= 800.50' / 800.00' S= 0.0128 '/' Cc= 0.900 n= 0.012, Flow Area= 1.23 sf
#3	Device 2	802.00'	6.0" Vert. Orifice/Grate C= 0.600 Limited to weir flow at low heads
#4	Device 2	802.60'	14.0' long Sharp-Crested Rectangular Weir 2 End Contraction(s)
#5	Secondary	803.00'	10.0' long + 3.0 ' SideZ x 8.0' breadth Broad-Crested Rectangular Weir Head (feet) 0.20 0.40 0.60 0.80 1.00 1.20 1.40 1.60 1.80 2.00 2.50 3.00 3.50 4.00 4.50 5.00 5.50 Coef. (English) 2.43 2.54 2.70 2.69 2.68 2.68 2.66 2.64 2.64 2.64 2.65 2.65 2.66 2.66 2.68 2.70 2.74

Discarded OutFlow Max=0.41 cfs @ 12.25 hrs HW=802.69' (Free Discharge)
 ↖1=Exfiltration (Exfiltration Controls 0.41 cfs)

Primary OutFlow Max=1.97 cfs @ 12.25 hrs HW=802.70' (Free Discharge)
 ↖2=Culvert (Passes 1.97 cfs of 5.85 cfs potential flow)
 ↖3=Orifice/Grate (Orifice Controls 0.63 cfs @ 3.21 fps)
 ↖4=Sharp-Crested Rectangular Weir (Weir Controls 1.34 cfs @ 1.01 fps)

Secondary OutFlow Max=0.00 cfs @ 5.00 hrs HW=800.00' (Free Discharge)
 ↖5=Broad-Crested Rectangular Weir (Controls 0.00 cfs)

Pond 17P: DET 220

Hydrograph

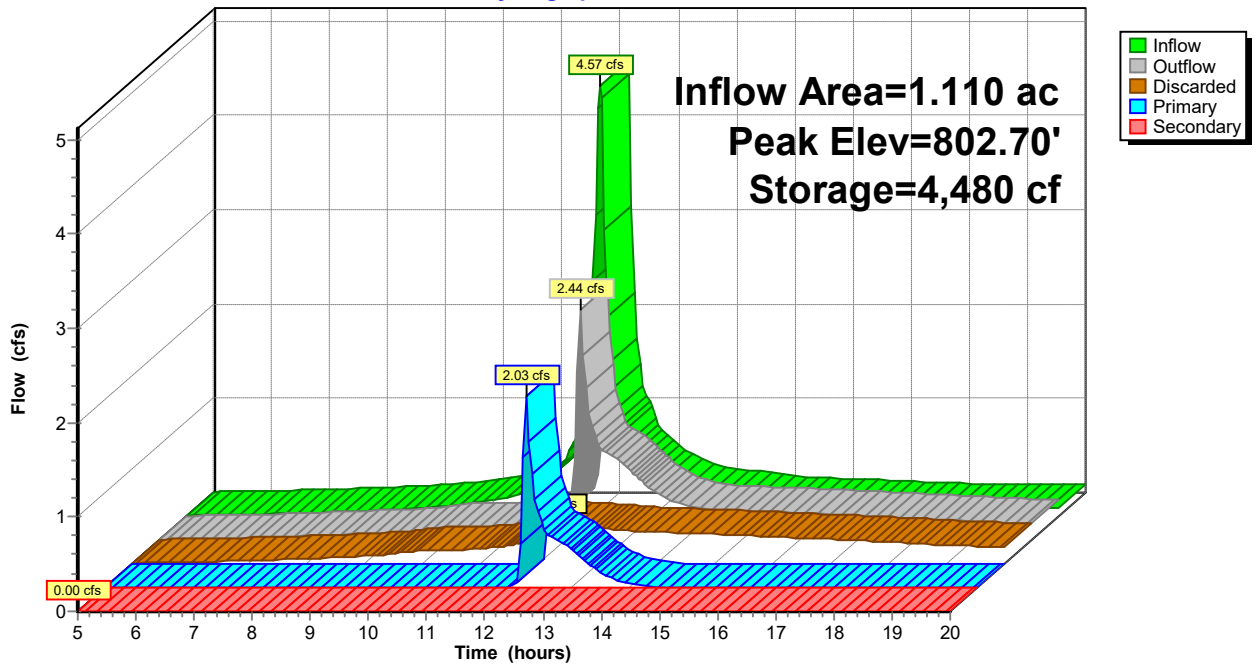

Summary for Pond 19P: PLUNGE POOL 120

Inflow Area = 0.990 ac, 0.00% Impervious, Inflow Depth > 2.20" for 10-Year event
 Inflow = 1.10 cfs @ 12.37 hrs, Volume= 0.181 af
 Outflow = 1.31 cfs @ 12.36 hrs, Volume= 0.170 af, Atten= 0%, Lag= 0.0 min
 Discarded = 0.02 cfs @ 12.36 hrs, Volume= 0.010 af
 Primary = 1.30 cfs @ 12.36 hrs, Volume= 0.160 af
 Routed to Link 15L : PR POA / A

Routing by Stor-Ind method, Time Span= 5.00-20.00 hrs, dt= 0.05 hrs
 Peak Elev= 815.07' @ 12.36 hrs Surf.Area= 783 sf Storage= 535 cf

Plug-Flow detention time= 26.0 min calculated for 0.169 af (94% of inflow)
 Center-of-Mass det. time= 9.0 min (862.8 - 853.8)

Volume	Invert	Avail.Storage	Storage Description
#1	814.00'	1,517 cf	Custom Stage Data (Prismatic) Listed below (Recalc)
Elevation (feet)	Surf.Area (sq-ft)	Inc.Store (cubic-feet)	Cum.Store (cubic-feet)
814.00	223	0	0
815.00	744	484	484
816.00	1,322	1,033	1,517

Device	Routing	Invert	Outlet Devices
#1	Discarded	814.00'	0.860 in/hr Exfiltration over Surface area
#2	Primary	815.00'	30.0' long + 3.0 ' SideZ x 8.0' breadth Broad-Crested Rectangular Weir
Head (feet) 0.20 0.40 0.60 0.80 1.00 1.20 1.40 1.60 1.80			
2.00 2.50 3.00 3.50 4.00 4.50 5.00 5.50			
Coef. (English) 2.43 2.54 2.70 2.69 2.68 2.68 2.66 2.64 2.64			
2.64 2.65 2.65 2.66 2.66 2.68 2.70 2.74			

Discarded OutFlow Max=0.02 cfs @ 12.36 hrs HW=815.06' (Free Discharge)
 ↑1=Exfiltration (Exfiltration Controls 0.02 cfs)

Primary OutFlow Max=1.18 cfs @ 12.36 hrs HW=815.06' (Free Discharge)
 ↑2=Broad-Crested Rectangular Weir (Weir Controls 1.18 cfs @ 0.61 fps)

Pond 19P: PLUNGE POOL 120

Hydrograph

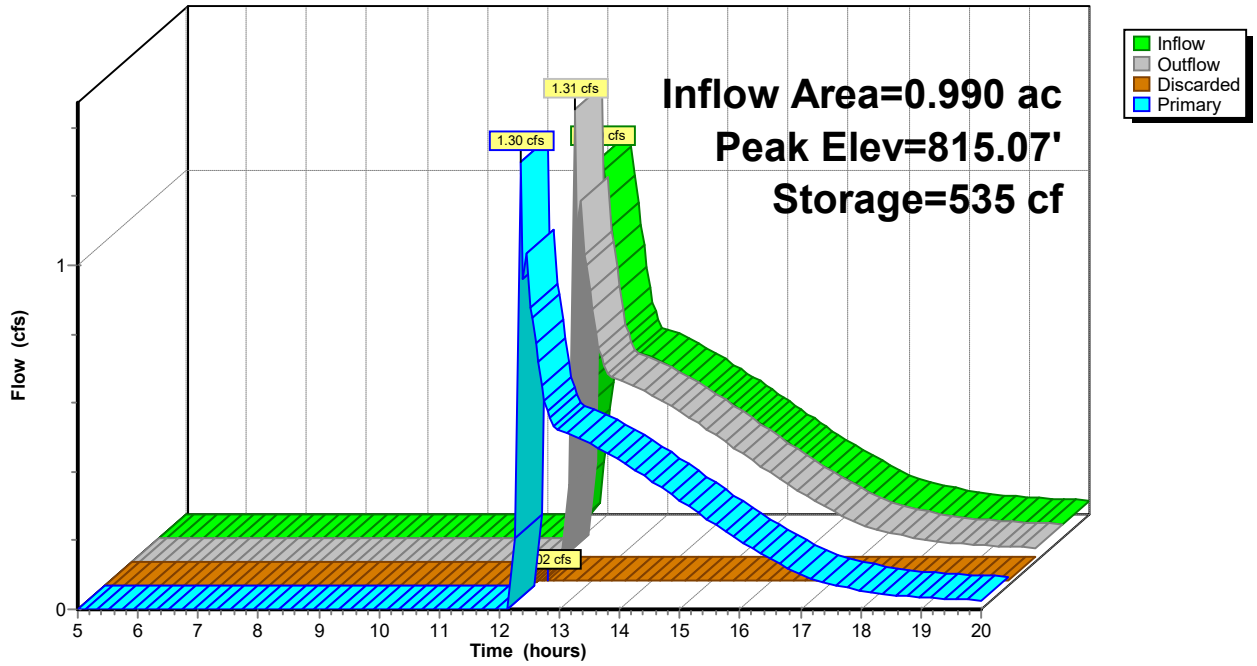

Summary for Link 4L: EX POA / A

Inflow Area = 18.510 ac, 0.00% Impervious, Inflow Depth > 2.09" for 10-Year event
Inflow = 21.53 cfs @ 12.54 hrs, Volume= 3.220 af
Primary = 21.53 cfs @ 12.54 hrs, Volume= 3.220 af, Atten= 0%, Lag= 0.0 min

Primary outflow = Inflow, Time Span= 5.00-20.00 hrs, dt= 0.05 hrs

Link 4L: EX POA / A

Hydrograph

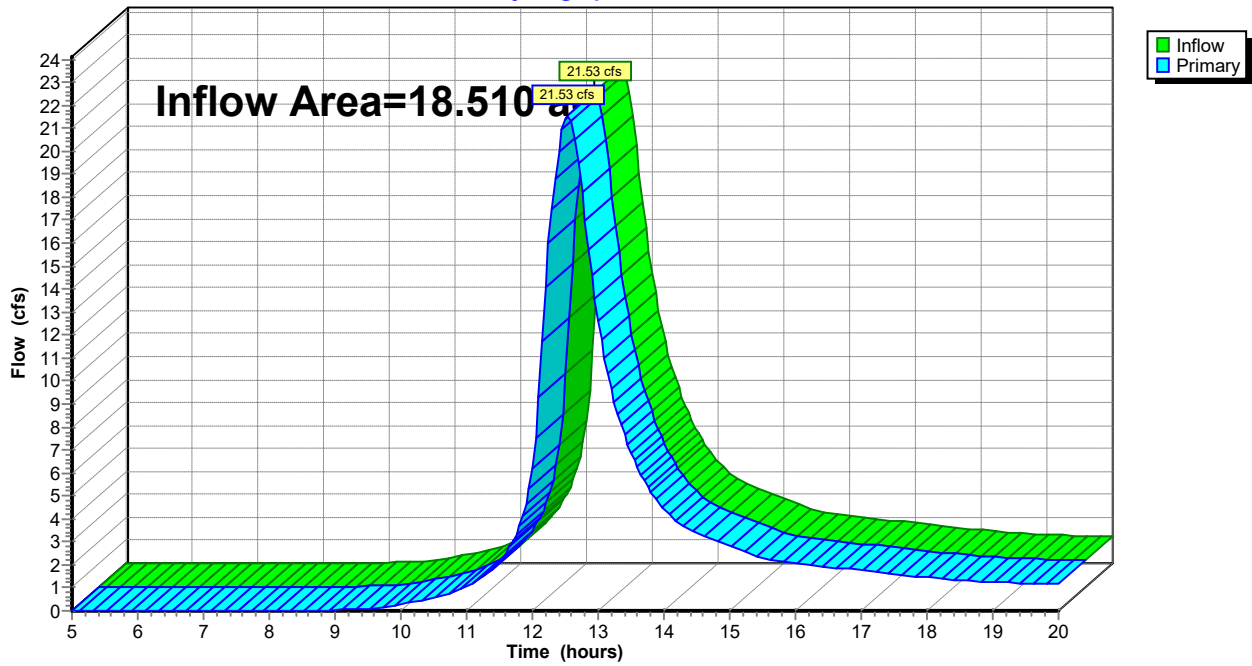

Summary for Link 15L: PR POA / A

Inflow Area = 17.680 ac, 0.00% Impervious, Inflow Depth > 2.15" for 10-Year event
Inflow = 21.20 cfs @ 12.55 hrs, Volume= 3.170 af
Primary = 21.20 cfs @ 12.55 hrs, Volume= 3.170 af, Atten= 0%, Lag= 0.0 min

Primary outflow = Inflow, Time Span= 5.00-20.00 hrs, dt= 0.05 hrs

Link 15L: PR POA / A

Hydrograph

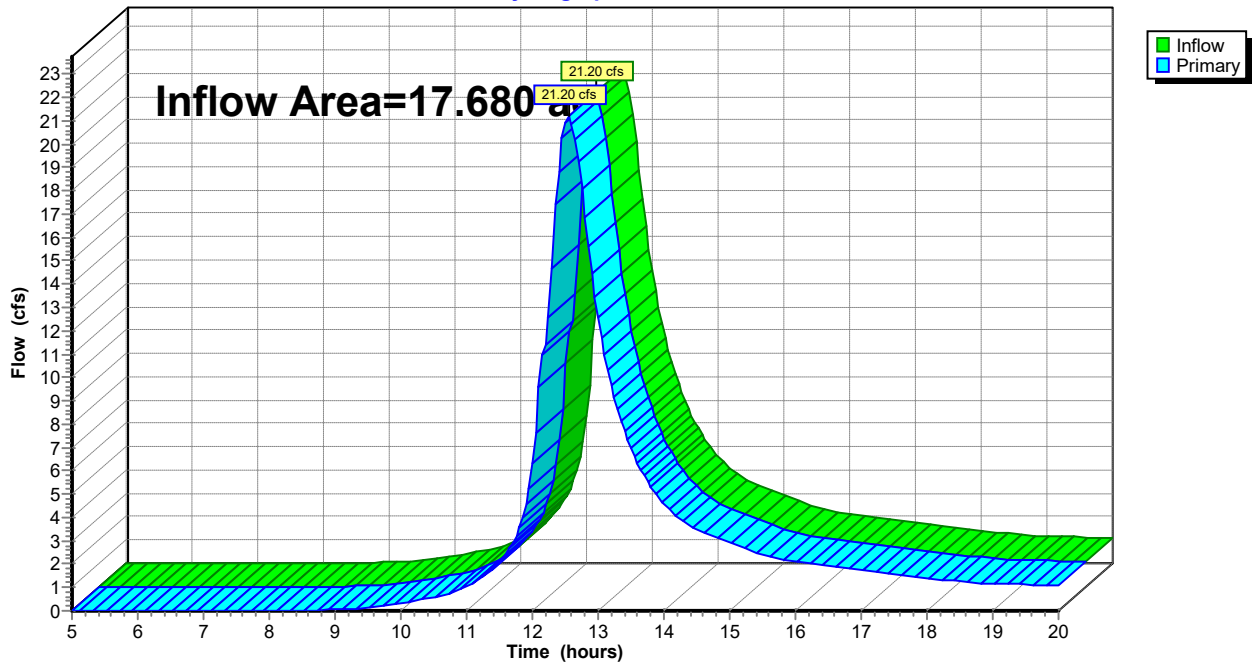

Summary for Link 18L: PR POA / B

Inflow Area = 6.280 ac, 0.00% Impervious, Inflow Depth > 1.58" for 10-Year event
Inflow = 10.05 cfs @ 12.25 hrs, Volume= 0.824 af
Primary = 10.05 cfs @ 12.25 hrs, Volume= 0.824 af, Atten= 0%, Lag= 0.0 min

Primary outflow = Inflow, Time Span= 5.00-20.00 hrs, dt= 0.05 hrs

Link 18L: PR POA / B

Hydrograph

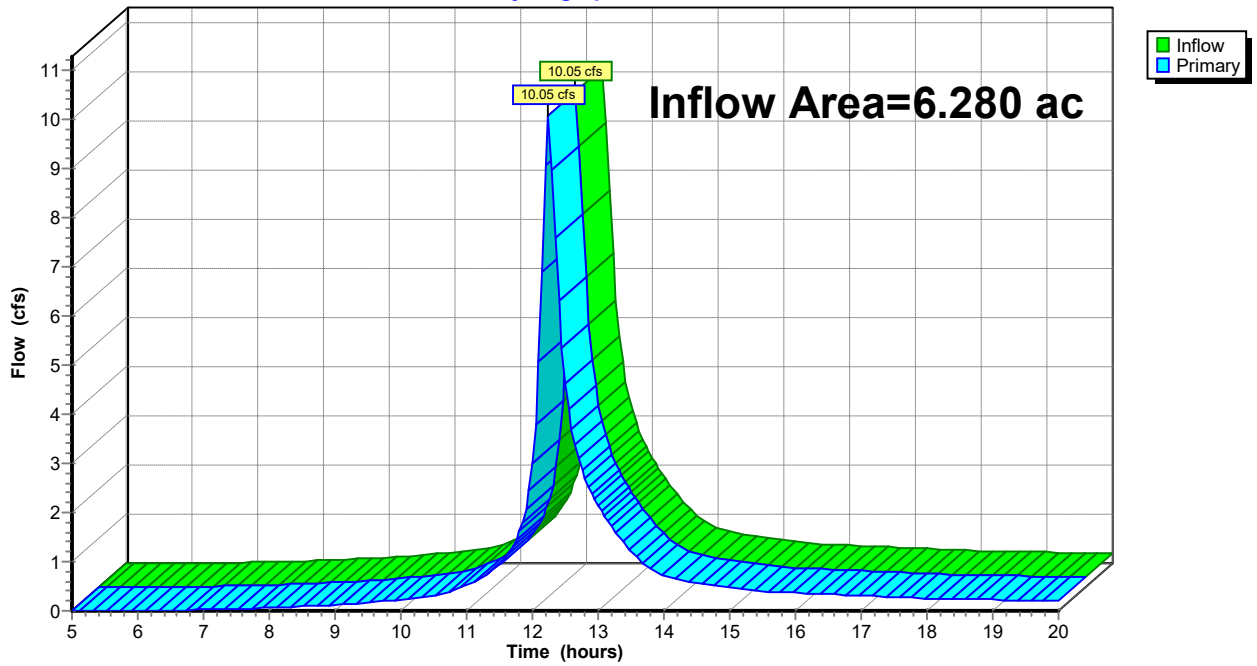

Summary for Subcatchment 1S: EXWS-10

Runoff = 7.94 cfs @ 12.22 hrs, Volume= 0.696 af, Depth> 3.39"
Routed to Link 4L : EX POA / A

Runoff by SCS TR-20 method, UH=SCS, Weighted-CN, Time Span= 5.00-20.00 hrs, dt= 0.05 hrs
NOAA 24-hr D 25-Year Rainfall=6.37"

Area (ac)	CN	Description
* 2.460	76	
2.460		100.00% Pervious Area

Tc (min)	Length (feet)	Slope (ft/ft)	Velocity (ft/sec)	Capacity (cfs)	Description
14.2					Direct Entry,

Subcatchment 1S: EXWS-10

Hydrograph

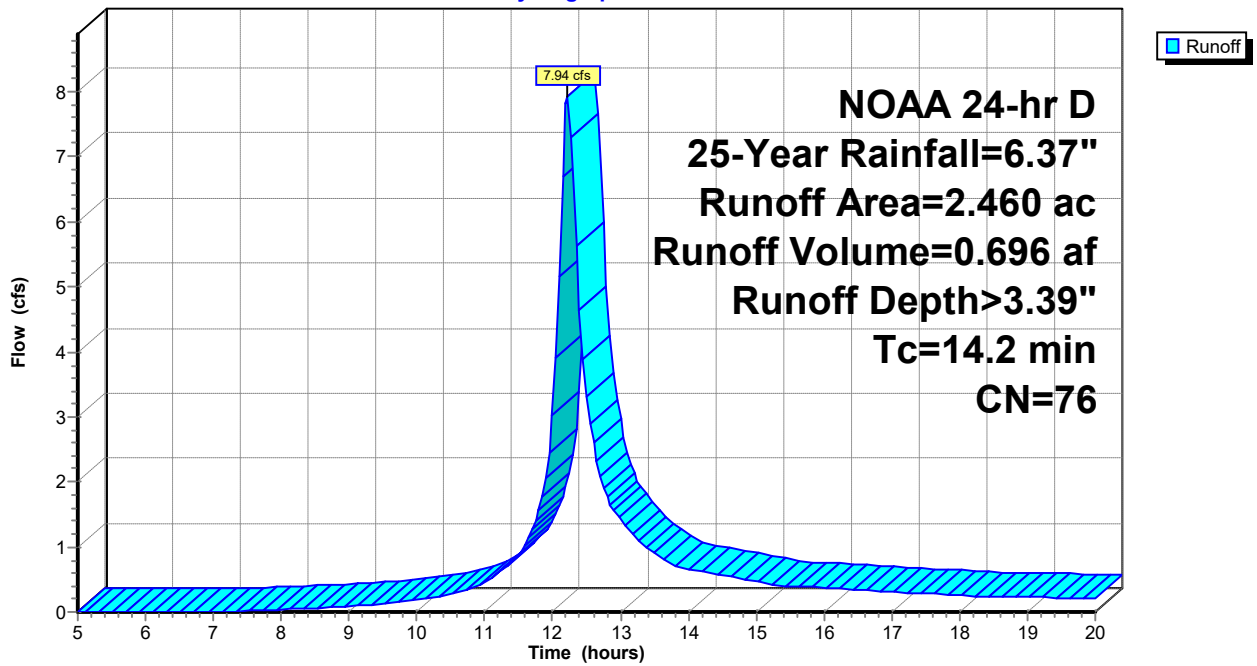

Summary for Subcatchment 2S: EXWS-11

Runoff = 28.34 cfs @ 12.55 hrs, Volume= 3.978 af, Depth> 2.97"
 Routed to Link 4L : EX POA / A

Runoff by SCS TR-20 method, UH=SCS, Weighted-CN, Time Span= 5.00-20.00 hrs, dt= 0.05 hrs
 NOAA 24-hr D 25-Year Rainfall=6.37"

Area (ac)	CN	Description
* 16.050	72	
16.050		100.00% Pervious Area

Tc (min)	Length (feet)	Slope (ft/ft)	Velocity (ft/sec)	Capacity (cfs)	Description
39.6					Direct Entry,

Subcatchment 2S: EXWS-11

Hydrograph

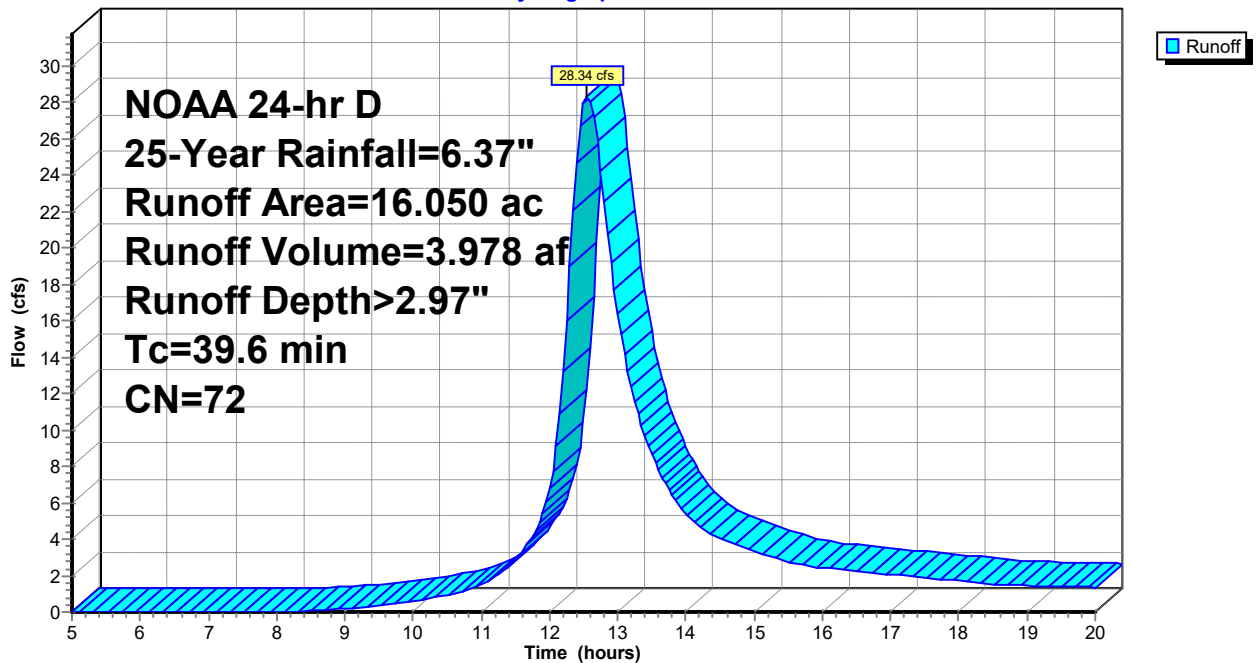

Summary for Subcatchment 5S: EXWS-20 / B

Runoff = 17.82 cfs @ 12.23 hrs, Volume= 1.624 af, Depth> 3.90"

Runoff by SCS TR-20 method, UH=SCS, Weighted-CN, Time Span= 5.00-20.00 hrs, dt= 0.05 hrs
 NOAA 24-hr D 25-Year Rainfall=6.37"

Area (ac)	CN	Description
* 5.000	81	
5.000		100.00% Pervious Area

Tc (min)	Length (feet)	Slope (ft/ft)	Velocity (ft/sec)	Capacity (cfs)	Description
14.9					Direct Entry,

Subcatchment 5S: EXWS-20 / B

Hydrograph

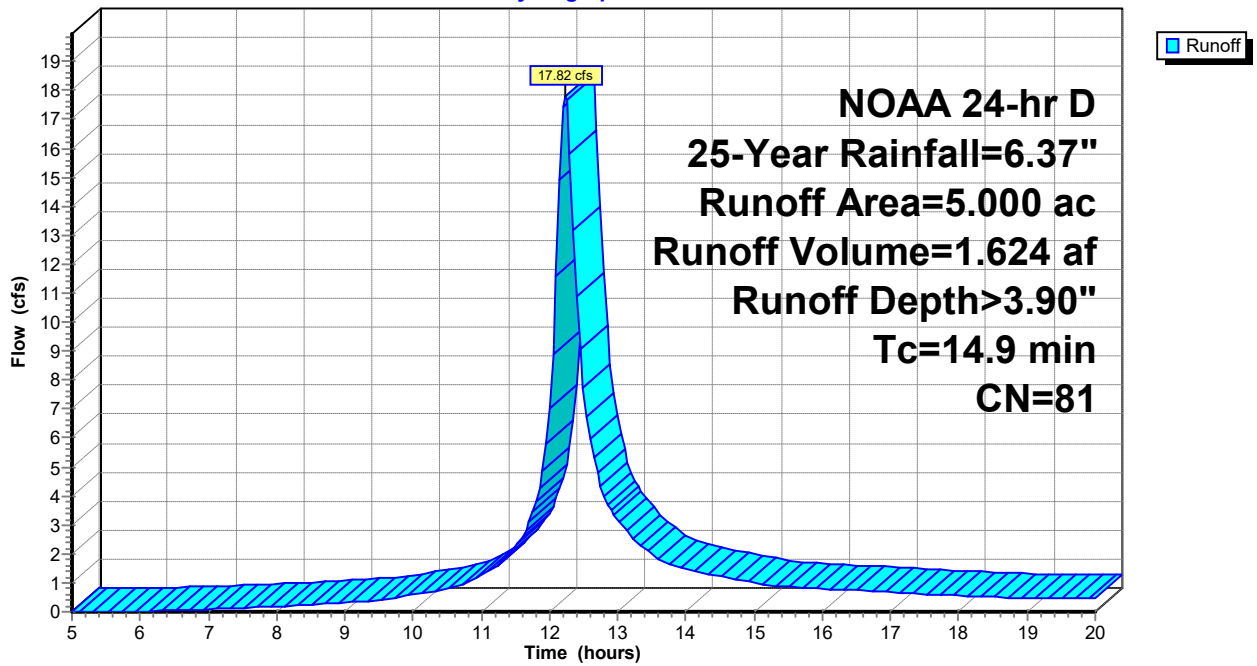

Summary for Subcatchment 6S: EXWS-30 / C

Runoff = 5.58 cfs @ 12.22 hrs, Volume= 0.486 af, Depth> 3.49"

Runoff by SCS TR-20 method, UH=SCS, Weighted-CN, Time Span= 5.00-20.00 hrs, dt= 0.05 hrs
 NOAA 24-hr D 25-Year Rainfall=6.37"

Area (ac)	CN	Description
* 1.670	77	
1.670		100.00% Pervious Area

Tc (min)	Length (feet)	Slope (ft/ft)	Velocity (ft/sec)	Capacity (cfs)	Description
14.0					Direct Entry,

Subcatchment 6S: EXWS-30 / C

Hydrograph

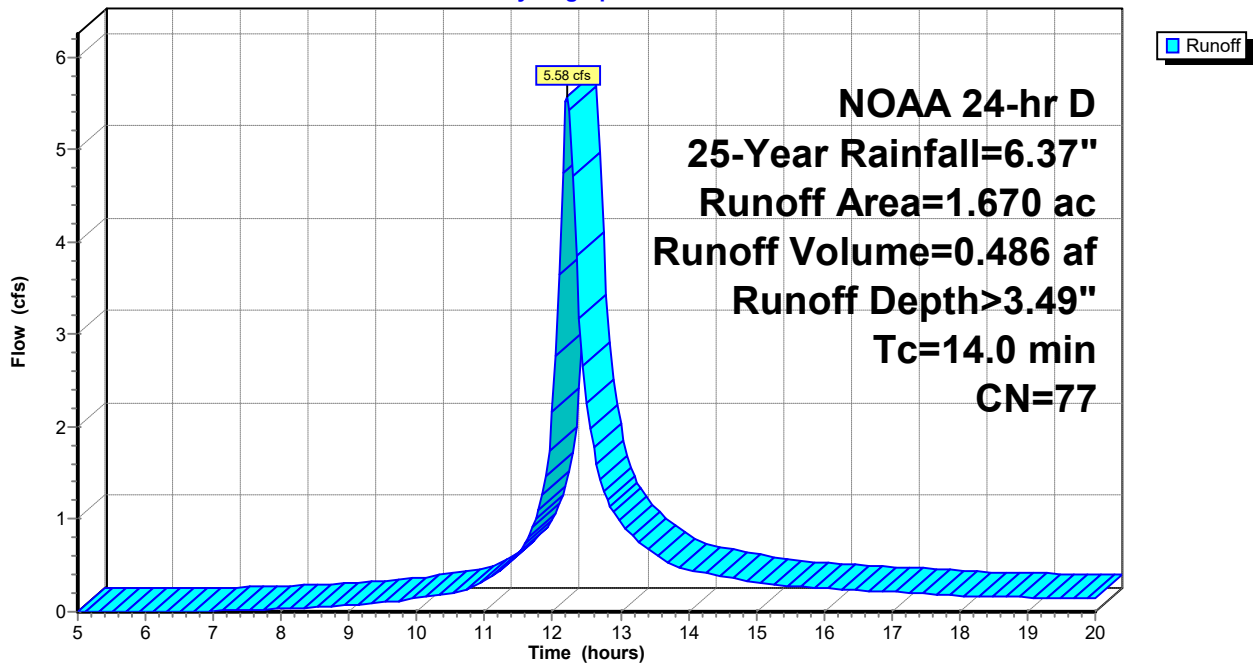

Summary for Subcatchment 7S: PRWS-10

Runoff = 5.34 cfs @ 12.13 hrs, Volume= 0.368 af, Depth> 3.81"
Routed to Link 15L : PR POA / A

Runoff by SCS TR-20 method, UH=SCS, Weighted-CN, Time Span= 5.00-20.00 hrs, dt= 0.05 hrs
NOAA 24-hr D 25-Year Rainfall=6.37"

Area (ac)	CN	Description
* 1.160	80	
1.160		100.00% Pervious Area

Tc (min)	Length (feet)	Slope (ft/ft)	Velocity (ft/sec)	Capacity (cfs)	Description
6.0					Direct Entry,

Subcatchment 7S: PRWS-10

Hydrograph

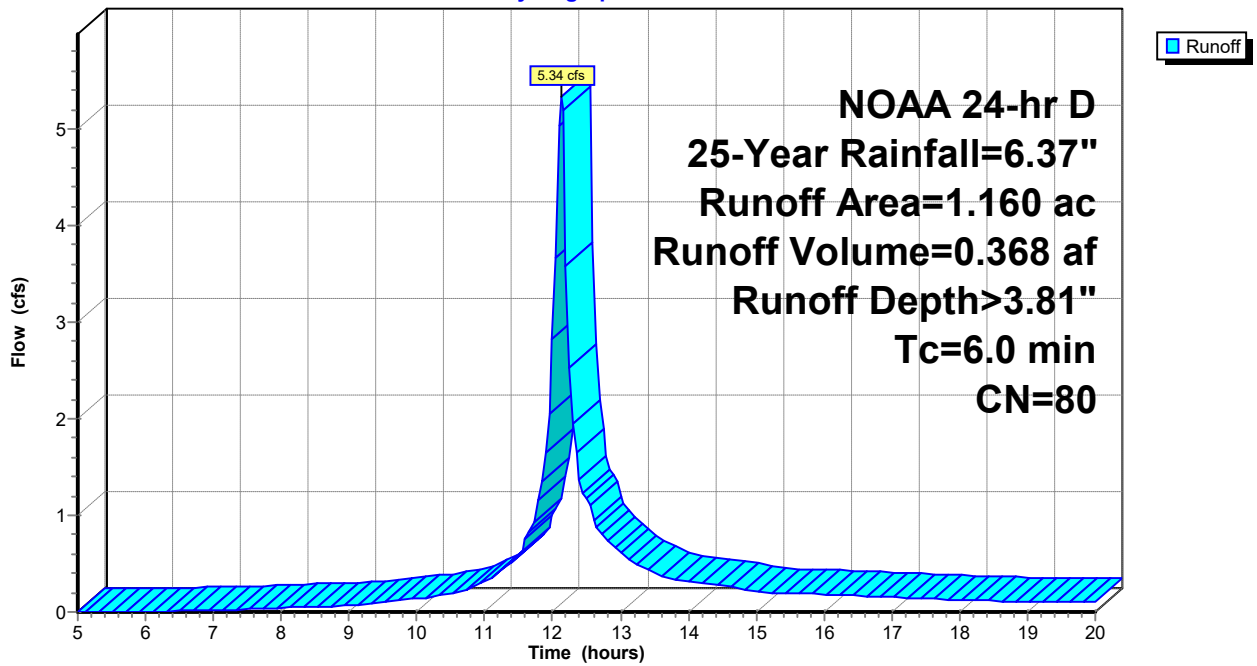

Summary for Subcatchment 8S: PRWS-11

Runoff = 28.28 cfs @ 12.55 hrs, Volume= 3.972 af, Depth> 3.07"
 Routed to Link 15L : PR POA / A

Runoff by SCS TR-20 method, UH=SCS, Weighted-CN, Time Span= 5.00-20.00 hrs, dt= 0.05 hrs
 NOAA 24-hr D 25-Year Rainfall=6.37"

Area (ac)	CN	Description
* 15.530	73	
15.530		100.00% Pervious Area

Tc (min)	Length (feet)	Slope (ft/ft)	Velocity (ft/sec)	Capacity (cfs)	Description
39.6					Direct Entry,

Subcatchment 8S: PRWS-11

Hydrograph

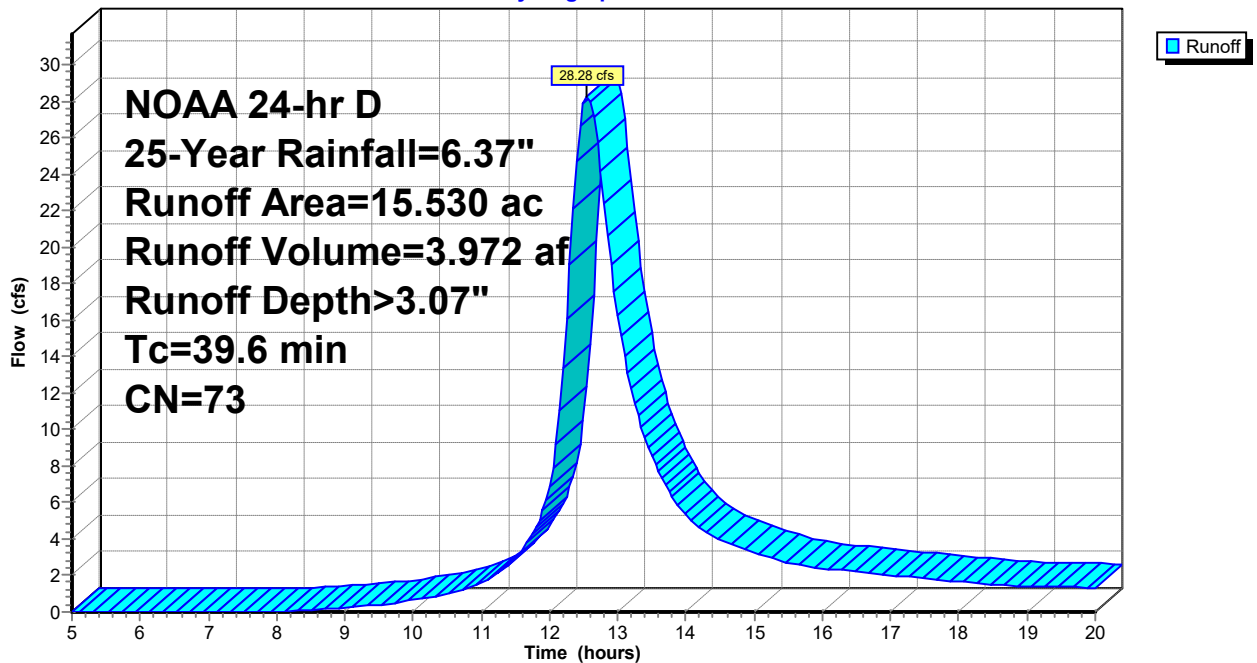

Summary for Subcatchment 9S: PRWS-12

Runoff = 5.13 cfs @ 12.13 hrs, Volume= 0.366 af, Depth> 4.43"
 Routed to Pond 14P : UG 120

Runoff by SCS TR-20 method, UH=SCS, Weighted-CN, Time Span= 5.00-20.00 hrs, dt= 0.05 hrs
 NOAA 24-hr D 25-Year Rainfall=6.37"

Area (ac)	CN	Description
* 0.990	86	
0.990		100.00% Pervious Area

Tc (min)	Length (feet)	Slope (ft/ft)	Velocity (ft/sec)	Capacity (cfs)	Description
6.0					Direct Entry,

Subcatchment 9S: PRWS-12

Hydrograph

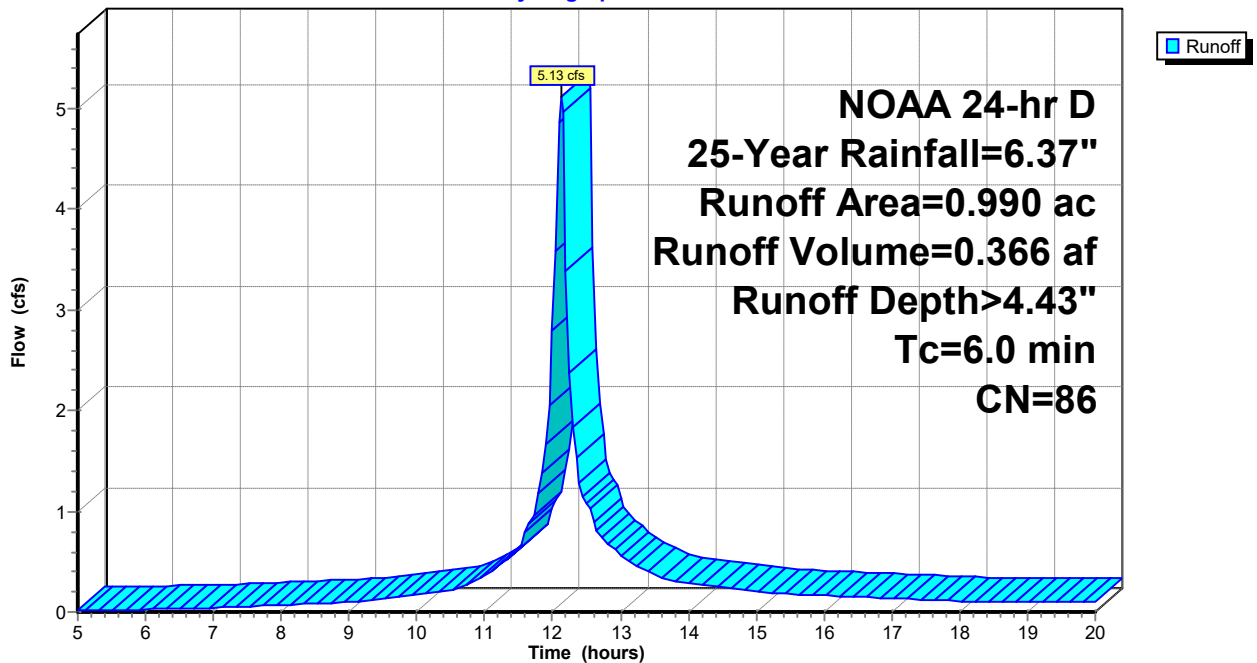

Summary for Subcatchment 10S: PRWS-20

Runoff = 10.62 cfs @ 12.24 hrs, Volume= 0.984 af, Depth> 4.00"
 Routed to Link 18L : PR POA / B

Runoff by SCS TR-20 method, UH=SCS, Weighted-CN, Time Span= 5.00-20.00 hrs, dt= 0.05 hrs
 NOAA 24-hr D 25-Year Rainfall=6.37"

Area (ac)	CN	Description
* 2.950	82	
2.950		100.00% Pervious Area

Tc (min)	Length (feet)	Slope (ft/ft)	Velocity (ft/sec)	Capacity (cfs)	Description
15.4					Direct Entry,

Subcatchment 10S: PRWS-20

Hydrograph

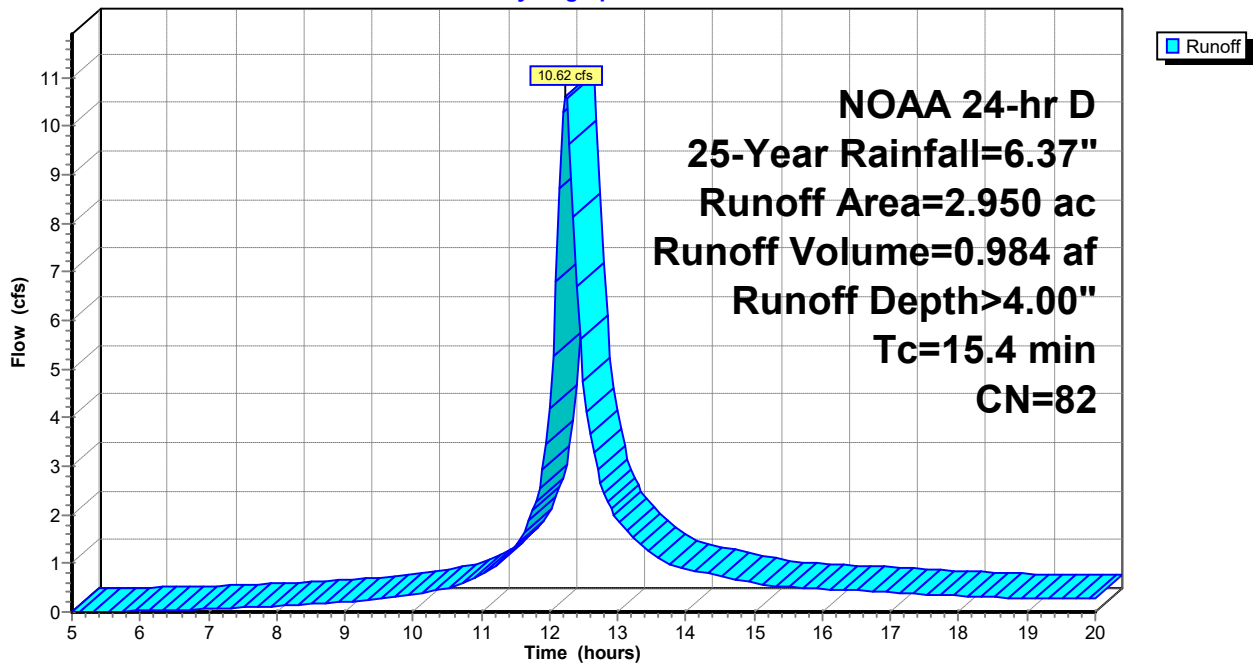

Summary for Subcatchment 11S: PRWS-21

Runoff = 11.66 cfs @ 12.14 hrs, Volume= 0.858 af, Depth> 4.64"
 Routed to Pond 16P : DET 210

Runoff by SCS TR-20 method, UH=SCS, Weighted-CN, Time Span= 5.00-20.00 hrs, dt= 0.05 hrs
 NOAA 24-hr D 25-Year Rainfall=6.37"

Area (ac)	CN	Description
* 2.220	88	
2.220		100.00% Pervious Area

Tc (min)	Length (feet)	Slope (ft/ft)	Velocity (ft/sec)	Capacity (cfs)	Description
6.8					Direct Entry,

Subcatchment 11S: PRWS-21

Hydrograph

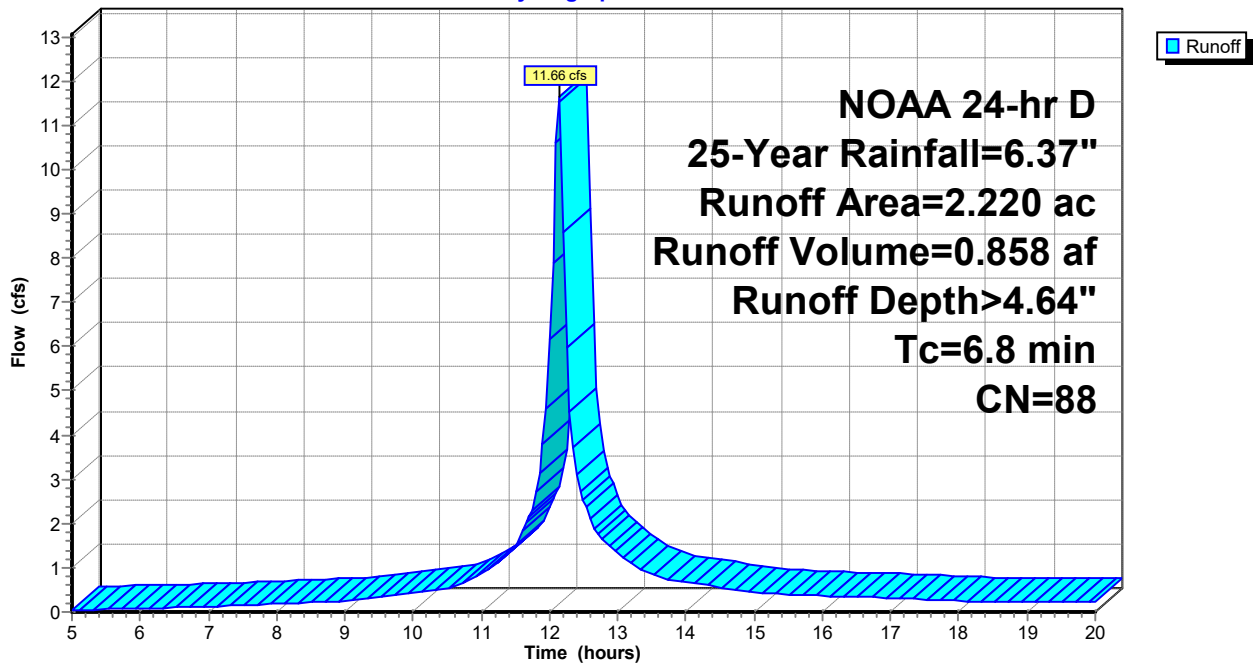

Summary for Subcatchment 12S: PRWS-22

Runoff = 5.93 cfs @ 12.13 hrs, Volume= 0.429 af, Depth> 4.64"
 Routed to Pond 17P : DET 220

Runoff by SCS TR-20 method, UH=SCS, Weighted-CN, Time Span= 5.00-20.00 hrs, dt= 0.05 hrs
 NOAA 24-hr D 25-Year Rainfall=6.37"

Area (ac)	CN	Description
* 1.110	88	
1.110		100.00% Pervious Area

Tc (min)	Length (feet)	Slope (ft/ft)	Velocity (ft/sec)	Capacity (cfs)	Description
6.0					Direct Entry,

Subcatchment 12S: PRWS-22

Hydrograph

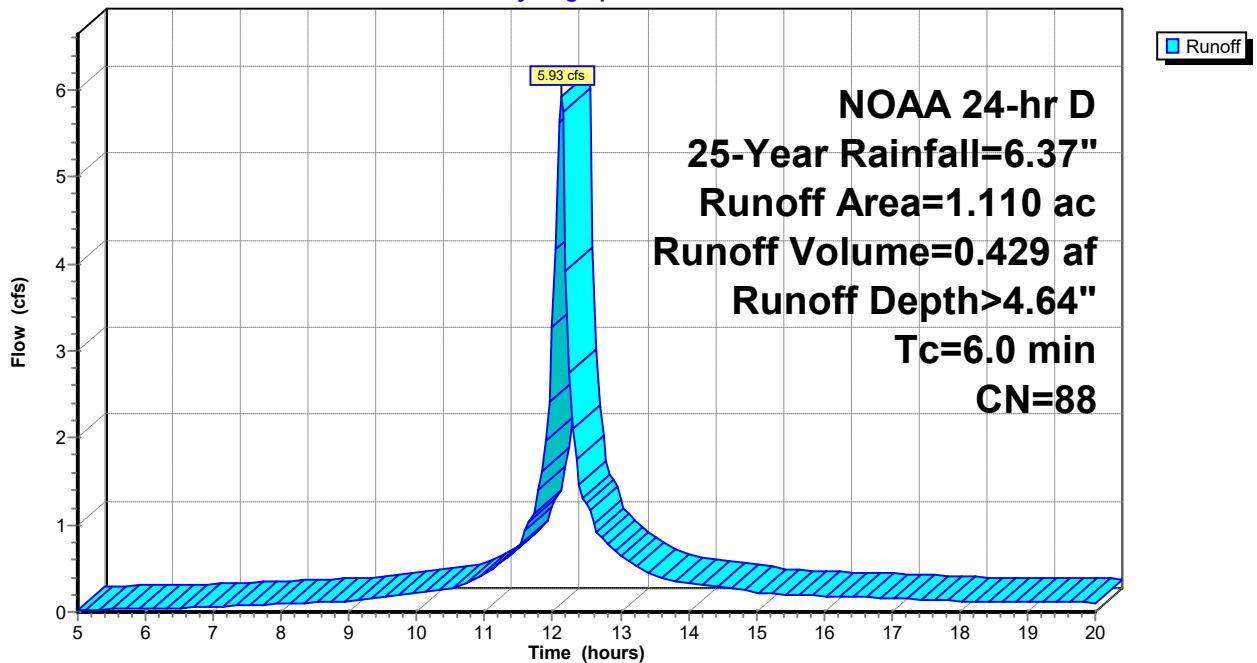

Summary for Subcatchment 13S: PRWS-30 / C

Runoff = 4.71 cfs @ 12.21 hrs, Volume= 0.407 af, Depth> 3.70"

Runoff by SCS TR-20 method, UH=SCS, Weighted-CN, Time Span= 5.00-20.00 hrs, dt= 0.05 hrs
 NOAA 24-hr D 25-Year Rainfall=6.37"

Area (ac)	CN	Description
* 1.320	79	
1.320		100.00% Pervious Area

Tc (min)	Length (feet)	Slope (ft/ft)	Velocity (ft/sec)	Capacity (cfs)	Description
13.4					Direct Entry,

Subcatchment 13S: PRWS-30 / C

Hydrograph

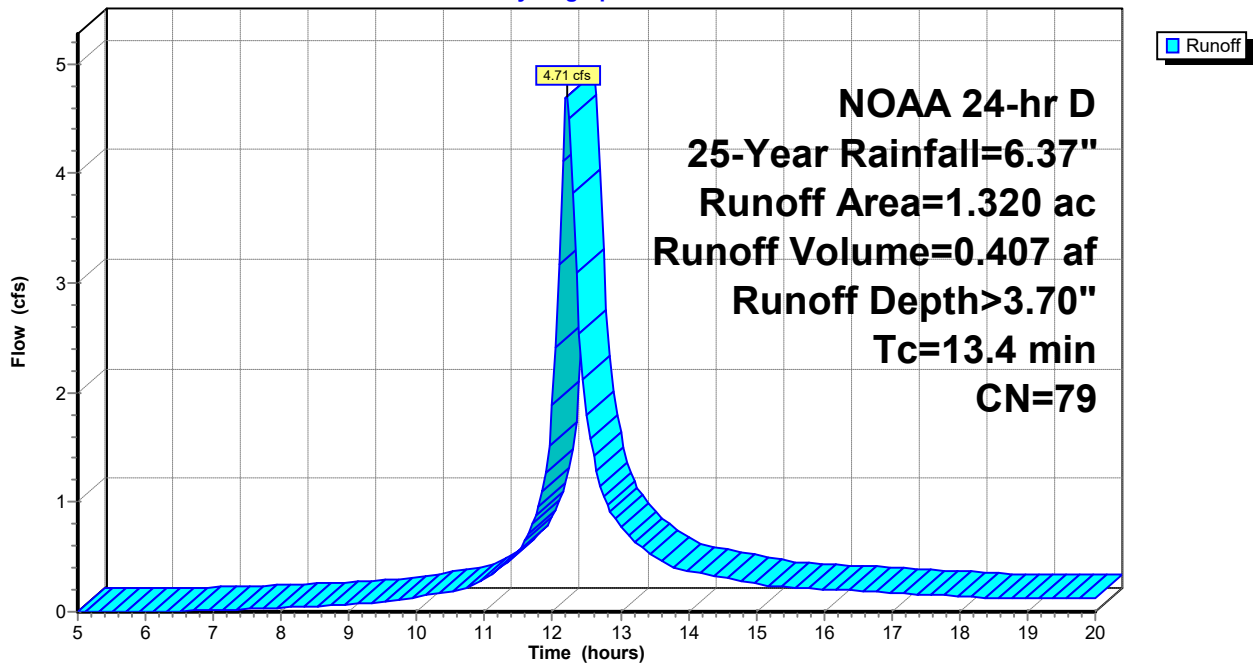

Summary for Pond 14P: UG 120

Inflow Area = 0.990 ac, 0.00% Impervious, Inflow Depth > 4.43" for 25-Year event
 Inflow = 5.13 cfs @ 12.13 hrs, Volume= 0.366 af
 Outflow = 3.91 cfs @ 12.20 hrs, Volume= 0.313 af, Atten= 24%, Lag= 4.4 min
 Discarded = 0.04 cfs @ 7.35 hrs, Volume= 0.044 af
 Primary = 3.87 cfs @ 12.20 hrs, Volume= 0.269 af
 Routed to Pond 19P : PLUNGE POOL 120

Routing by Stor-Ind method, Time Span= 5.00-20.00 hrs, dt= 0.05 hrs
 Peak Elev= 818.41' @ 12.20 hrs Surf.Area= 0.044 ac Storage= 0.132 af

Plug-Flow detention time= 110.1 min calculated for 0.313 af (86% of inflow)
 Center-of-Mass det. time= 64.7 min (829.3 - 764.6)

Volume	Invert	Avail.Storage	Storage Description
#1A	815.00'	0.000 af	24.00'W x 80.00'L x 4.67'H Field A 0.206 af Overall - 0.206 af Embedded = 0.000 af x 40.0% Voids
#2A	815.00'	0.155 af	retain_it retain_it 4.0' x 30 Inside #1 Inside= 84.0"W x 48.0"H => 28.87 sf x 8.00'L = 230.9 cf Outside= 96.0"W x 56.0"H => 37.33 sf x 8.00'L = 298.7 cf 3 Rows adjusted for 196.3 cf perimeter wall
		0.155 af	Total Available Storage

Storage Group A created with Chamber Wizard

Device	Routing	Invert	Outlet Devices
#1	Discarded	815.00'	0.860 in/hr Exfiltration over Surface area
#2	Primary	815.00'	12.0" Round Culvert L= 30.0' CPP, projecting, no headwall, Ke= 0.900 Inlet / Outlet Invert= 815.00' / 814.00' S= 0.0333 '/' Cc= 0.900 n= 0.012, Flow Area= 0.79 sf
#3	Device 2	816.20'	4.0" Vert. Orifice/Grate C= 0.600 Limited to weir flow at low heads
#4	Device 2	818.00'	3.9' long Sharp-Crested Rectangular Weir 2 End Contraction(s)

Discarded OutFlow Max=0.04 cfs @ 7.35 hrs HW=815.05' (Free Discharge)
 ↳ **1=Exfiltration** (Exfiltration Controls 0.04 cfs)

Primary OutFlow Max=3.85 cfs @ 12.20 hrs HW=818.41' (Free Discharge)
 ↳ **2=Culvert** (Passes 3.85 cfs of 5.09 cfs potential flow)
 ↳ **3=Orifice/Grate** (Orifice Controls 0.60 cfs @ 6.88 fps)
 ↳ **4=Sharp-Crested Rectangular Weir** (Weir Controls 3.25 cfs @ 2.09 fps)

Pond 14P: UG 120

Hydrograph

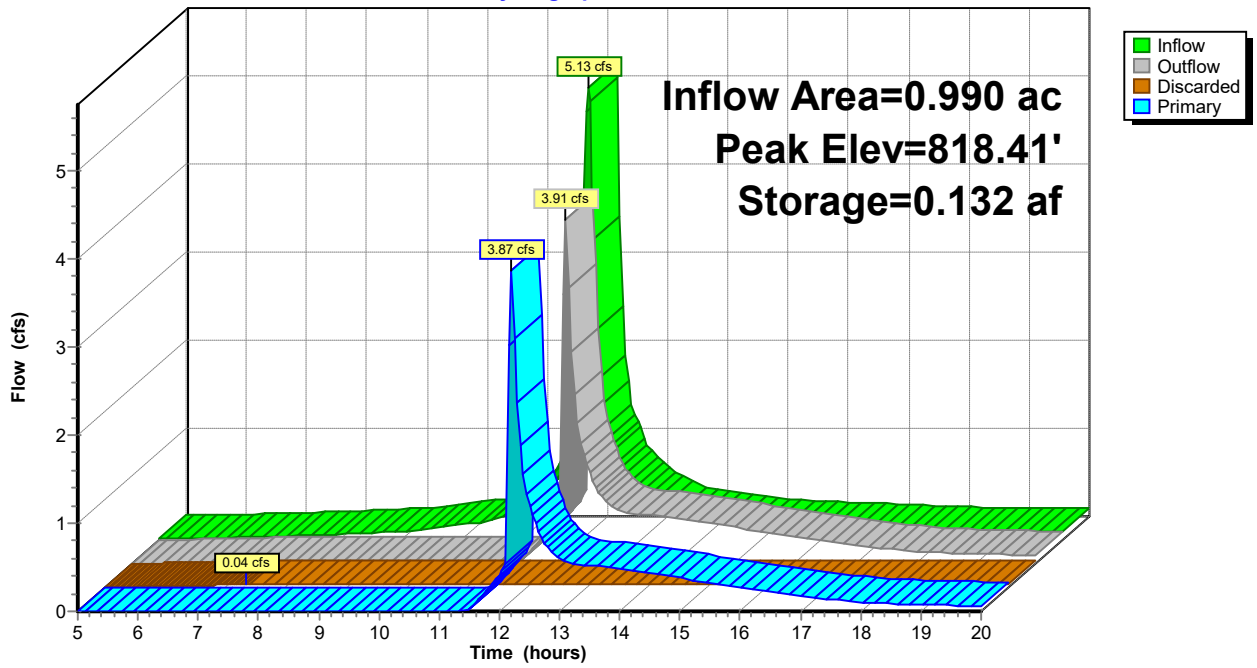

Summary for Pond 16P: DET 210

Inflow Area = 2.220 ac, 0.00% Impervious, Inflow Depth > 4.64" for 25-Year event
 Inflow = 11.66 cfs @ 12.14 hrs, Volume= 0.858 af
 Outflow = 2.08 cfs @ 12.61 hrs, Volume= 0.857 af, Atten= 82%, Lag= 28.3 min
 Discarded = 1.39 cfs @ 12.61 hrs, Volume= 0.763 af
 Primary = 0.68 cfs @ 12.61 hrs, Volume= 0.094 af
 Routed to Link 18L : PR POA / B
 Secondary = 0.00 cfs @ 5.00 hrs, Volume= 0.000 af
 Routed to Link 18L : PR POA / B

Routing by Stor-Ind method, Time Span= 5.00-20.00 hrs, dt= 0.05 hrs
 Peak Elev= 816.37' @ 12.61 hrs Surf.Area= 9,412 sf Storage= 11,609 cf

Plug-Flow detention time= 49.6 min calculated for 0.857 af (100% of inflow)
 Center-of-Mass det. time= 49.0 min (809.2 - 760.2)

Volume	Invert	Avail.Storage	Storage Description		
#1	815.00'	28,806 cf	Custom Stage Data (Conic) Listed below (Recalc)		
Elevation (feet)	Surf.Area (sq-ft)	Inc.Store (cubic-feet)	Cum.Store (cubic-feet)	Wet.Area (sq-ft)	
815.00	7,517	0	0	7,517	
816.00	8,907	8,202	8,202	8,944	
817.00	10,296	9,593	17,795	10,375	
818.00	11,741	11,011	28,806	11,867	

Device	Routing	Invert	Outlet Devices
#1	Discarded	815.00'	6.400 in/hr Exfiltration over Surface area
#2	Primary	815.00'	12.0" Round Culvert L= 127.0' CPP, projecting, no headwall, Ke= 0.900 Inlet / Outlet Invert= 815.00' / 806.40' S= 0.0677 '/' Cc= 0.900 n= 0.012, Flow Area= 0.79 sf
#3	Device 2	815.60'	6.0" Vert. Orifice/Grate C= 0.600 Limited to weir flow at low heads
#4	Device 2	816.80'	14.0' long Sharp-Crested Rectangular Weir 2 End Contraction(s)
#5	Secondary	817.00'	10.0' long + 3.0 ' SideZ x 8.0' breadth Broad-Crested Rectangular Weir Head (feet) 0.20 0.40 0.60 0.80 1.00 1.20 1.40 1.60 1.80 2.00 2.50 3.00 3.50 4.00 4.50 5.00 5.50 Coef. (English) 2.43 2.54 2.70 2.69 2.68 2.68 2.66 2.64 2.64 2.64 2.65 2.65 2.66 2.66 2.68 2.70 2.74

Discarded OutFlow Max=1.39 cfs @ 12.61 hrs HW=816.37' (Free Discharge)
 ↑1=Exfiltration (Exfiltration Controls 1.39 cfs)

Primary OutFlow Max=0.68 cfs @ 12.61 hrs HW=816.37' (Free Discharge)
 ↑2=Culvert (Passes 0.68 cfs of 2.79 cfs potential flow)
 ↑3=Orifice/Grate (Orifice Controls 0.68 cfs @ 3.48 fps)
 ↑4=Sharp-Crested Rectangular Weir (Controls 0.00 cfs)

Secondary OutFlow Max=0.00 cfs @ 5.00 hrs HW=815.00' (Free Discharge)
 ↑5=Broad-Crested Rectangular Weir (Controls 0.00 cfs)

Pond 16P: DET 210

Hydrograph

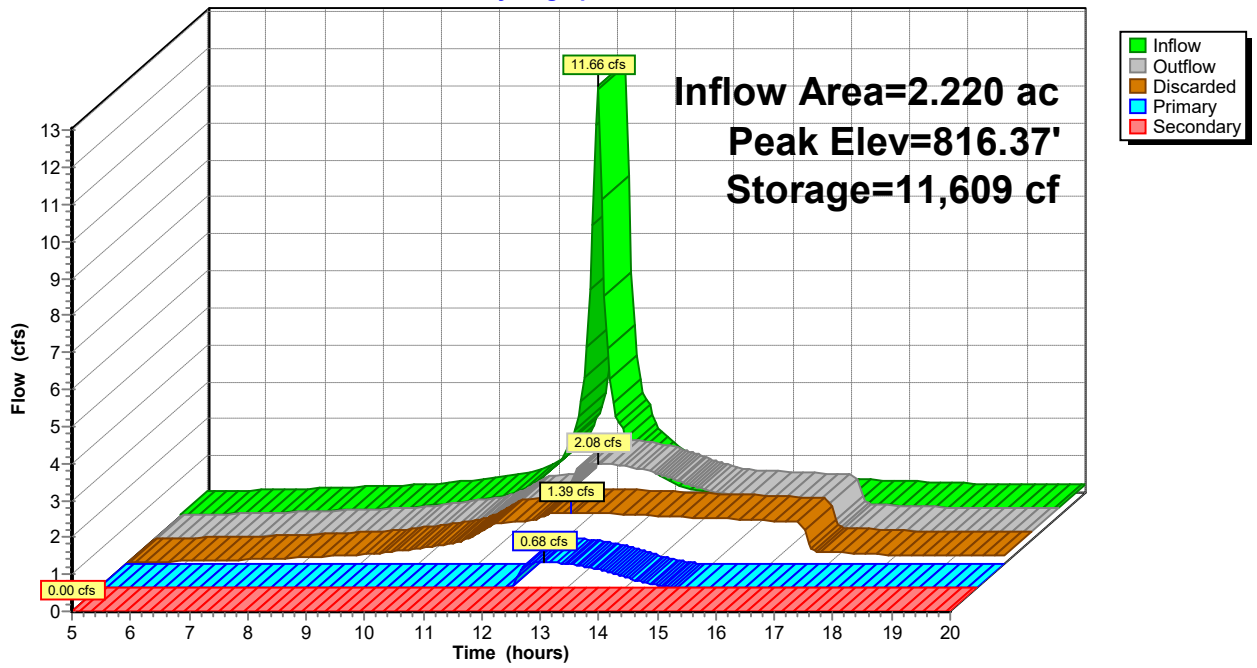

Summary for Pond 17P: DET 220

Inflow Area = 1.110 ac, 0.00% Impervious, Inflow Depth > 4.64" for 25-Year event
 Inflow = 5.93 cfs @ 12.13 hrs, Volume= 0.429 af
 Outflow = 5.78 cfs @ 12.16 hrs, Volume= 0.412 af, Atten= 3%, Lag= 2.2 min
 Discarded = 0.43 cfs @ 12.17 hrs, Volume= 0.269 af
 Primary = 5.35 cfs @ 12.16 hrs, Volume= 0.143 af
 Routed to Link 18L : PR POA / B
 Secondary = 0.00 cfs @ 5.00 hrs, Volume= 0.000 af
 Routed to Link 18L : PR POA / B

Routing by Stor-Ind method, Time Span= 5.00-20.00 hrs, dt= 0.05 hrs
 Peak Elev= 802.82' @ 12.17 hrs Surf.Area= 2,661 sf Storage= 4,799 cf

Plug-Flow detention time= 71.4 min calculated for 0.410 af (96% of inflow)
 Center-of-Mass det. time= 55.3 min (814.8 - 759.6)

Volume	Invert	Avail.Storage	Storage Description		
#1	800.00'	8,875 cf	Custom Stage Data (Conic) Listed below (Recalc)		
Elevation (feet)	Surf.Area (sq-ft)	Inc.Store (cubic-feet)	Cum.Store (cubic-feet)	Wet.Area (sq-ft)	
800.00	879	0	0	879	
801.00	1,441	1,148	1,148	1,454	
802.00	2,039	1,731	2,880	2,070	
803.00	2,810	2,414	5,294	2,860	
804.00	4,412	3,581	8,875	4,476	

Device	Routing	Invert	Outlet Devices
#1	Discarded	800.00'	6.900 in/hr Exfiltration over Surface area
#2	Primary	800.50'	15.0" Round Culvert L= 39.0' CPP, projecting, no headwall, Ke= 0.900 Inlet / Outlet Invert= 800.50' / 800.00' S= 0.0128 '/' Cc= 0.900 n= 0.012, Flow Area= 1.23 sf
#3	Device 2	802.00'	6.0" Vert. Orifice/Grate C= 0.600 Limited to weir flow at low heads
#4	Device 2	802.60'	14.0' long Sharp-Crested Rectangular Weir 2 End Contraction(s)
#5	Secondary	803.00'	10.0' long + 3.0 ' SideZ x 8.0' breadth Broad-Crested Rectangular Weir Head (feet) 0.20 0.40 0.60 0.80 1.00 1.20 1.40 1.60 1.80 2.00 2.50 3.00 3.50 4.00 4.50 5.00 5.50 Coef. (English) 2.43 2.54 2.70 2.69 2.68 2.68 2.66 2.64 2.64 2.64 2.65 2.65 2.66 2.66 2.68 2.70 2.74

Discarded OutFlow Max=0.42 cfs @ 12.17 hrs HW=802.80' (Free Discharge)
 ↖1=Exfiltration (Exfiltration Controls 0.42 cfs)

Primary OutFlow Max=4.92 cfs @ 12.16 hrs HW=802.80' (Free Discharge)
 ↖2=Culvert (Passes 4.92 cfs of 6.05 cfs potential flow)
 ↖3=Orifice/Grate (Orifice Controls 0.70 cfs @ 3.59 fps)
 ↖4=Sharp-Crested Rectangular Weir (Weir Controls 4.22 cfs @ 1.48 fps)

Secondary OutFlow Max=0.00 cfs @ 5.00 hrs HW=800.00' (Free Discharge)
 ↖5=Broad-Crested Rectangular Weir (Controls 0.00 cfs)

Pond 17P: DET 220

Hydrograph

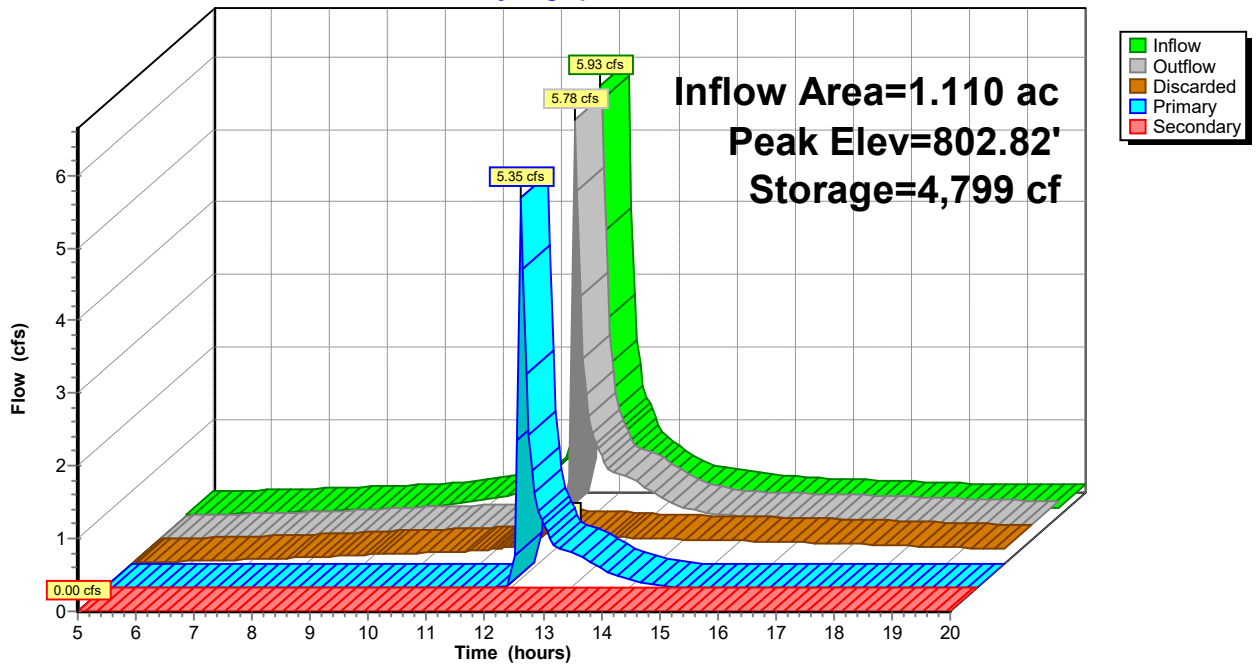

Summary for Pond 19P: PLUNGE POOL 120

Inflow Area = 0.990 ac, 0.00% Impervious, Inflow Depth > 3.26" for 25-Year event
 Inflow = 3.87 cfs @ 12.20 hrs, Volume= 0.269 af
 Outflow = 4.01 cfs @ 12.21 hrs, Volume= 0.258 af, Atten= 0%, Lag= 0.3 min
 Discarded = 0.02 cfs @ 12.21 hrs, Volume= 0.010 af
 Primary = 4.00 cfs @ 12.21 hrs, Volume= 0.248 af
 Routed to Link 15L : PR POA / A

Routing by Stor-Ind method, Time Span= 5.00-20.00 hrs, dt= 0.05 hrs
 Peak Elev= 815.14' @ 12.21 hrs Surf.Area= 827 sf Storage= 596 cf

Plug-Flow detention time= 19.3 min calculated for 0.258 af (96% of inflow)
 Center-of-Mass det. time= 6.0 min (842.5 - 836.5)

Volume	Invert	Avail.Storage	Storage Description
#1	814.00'	1,517 cf	Custom Stage Data (Prismatic) Listed below (Recalc)
Elevation (feet)	Surf.Area (sq-ft)	Inc.Store (cubic-feet)	Cum.Store (cubic-feet)
814.00	223	0	0
815.00	744	484	484
816.00	1,322	1,033	1,517

Device	Routing	Invert	Outlet Devices
#1	Discarded	814.00'	0.860 in/hr Exfiltration over Surface area
#2	Primary	815.00'	30.0' long + 3.0 ' SideZ x 8.0' breadth Broad-Crested Rectangular Weir
Head (feet) 0.20 0.40 0.60 0.80 1.00 1.20 1.40 1.60 1.80			
2.00 2.50 3.00 3.50 4.00 4.50 5.00 5.50			
Coef. (English) 2.43 2.54 2.70 2.69 2.68 2.68 2.66 2.64 2.64			
2.64 2.65 2.65 2.66 2.66 2.68 2.70 2.74			

Discarded OutFlow Max=0.02 cfs @ 12.21 hrs HW=815.14' (Free Discharge)
 ↑1=Exfiltration (Exfiltration Controls 0.02 cfs)

Primary OutFlow Max=3.86 cfs @ 12.21 hrs HW=815.14' (Free Discharge)
 ↑2=Broad-Crested Rectangular Weir (Weir Controls 3.86 cfs @ 0.91 fps)

Pond 19P: PLUNGE POOL 120

Hydrograph

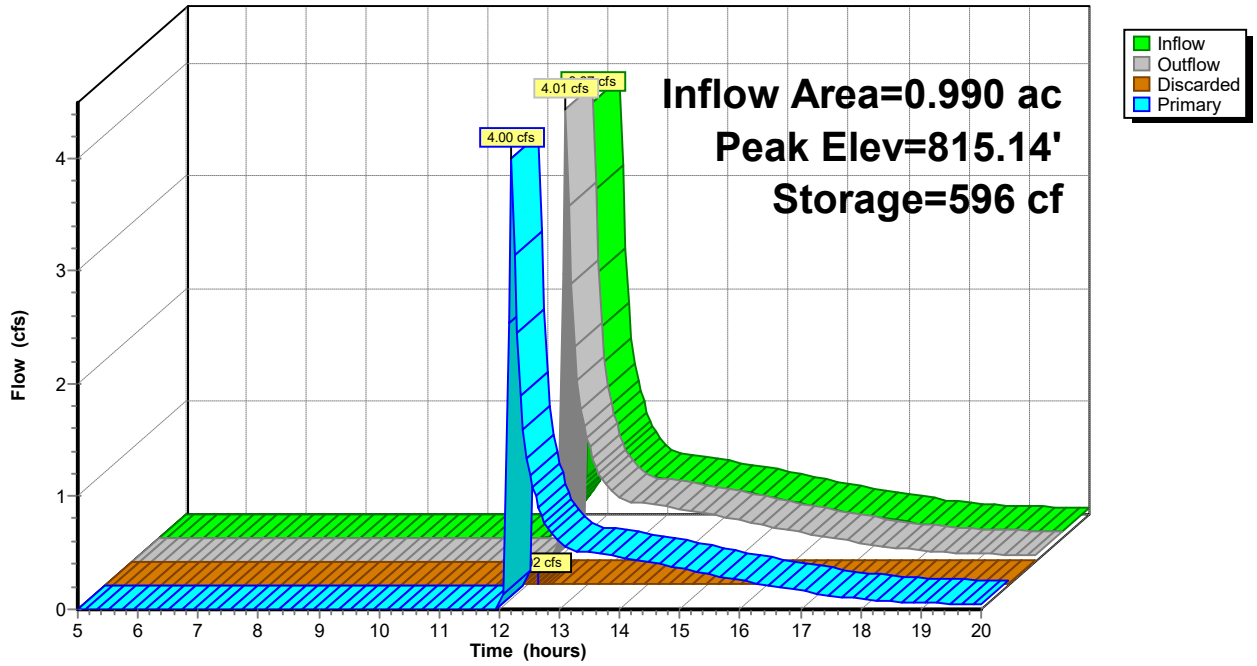

Summary for Link 4L: EX POA / A

Inflow Area = 18.510 ac, 0.00% Impervious, Inflow Depth > 3.03" for 25-Year event
Inflow = 31.30 cfs @ 12.53 hrs, Volume= 4.674 af
Primary = 31.30 cfs @ 12.53 hrs, Volume= 4.674 af, Atten= 0%, Lag= 0.0 min

Primary outflow = Inflow, Time Span= 5.00-20.00 hrs, dt= 0.05 hrs

Link 4L: EX POA / A

Hydrograph

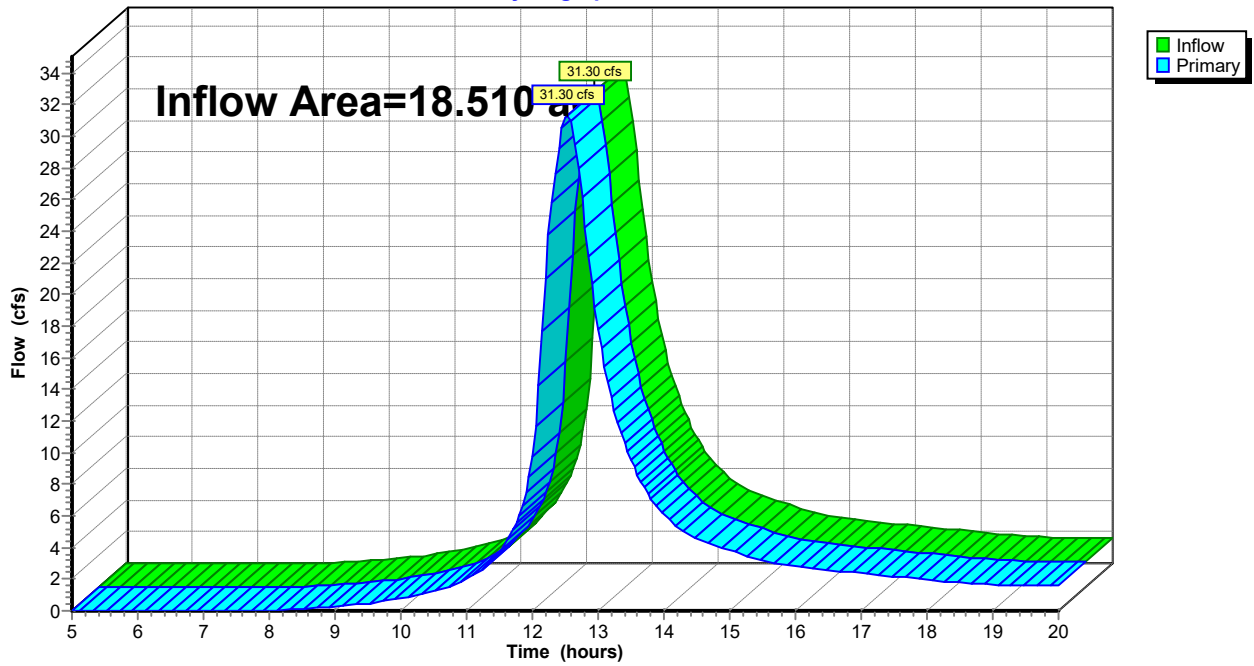

Summary for Link 15L: PR POA / A

Inflow Area = 17.680 ac, 0.00% Impervious, Inflow Depth > 3.11" for 25-Year event
Inflow = 30.48 cfs @ 12.54 hrs, Volume= 4.588 af
Primary = 30.48 cfs @ 12.54 hrs, Volume= 4.588 af, Atten= 0%, Lag= 0.0 min

Primary outflow = Inflow, Time Span= 5.00-20.00 hrs, dt= 0.05 hrs

Link 15L: PR POA / A

Hydrograph

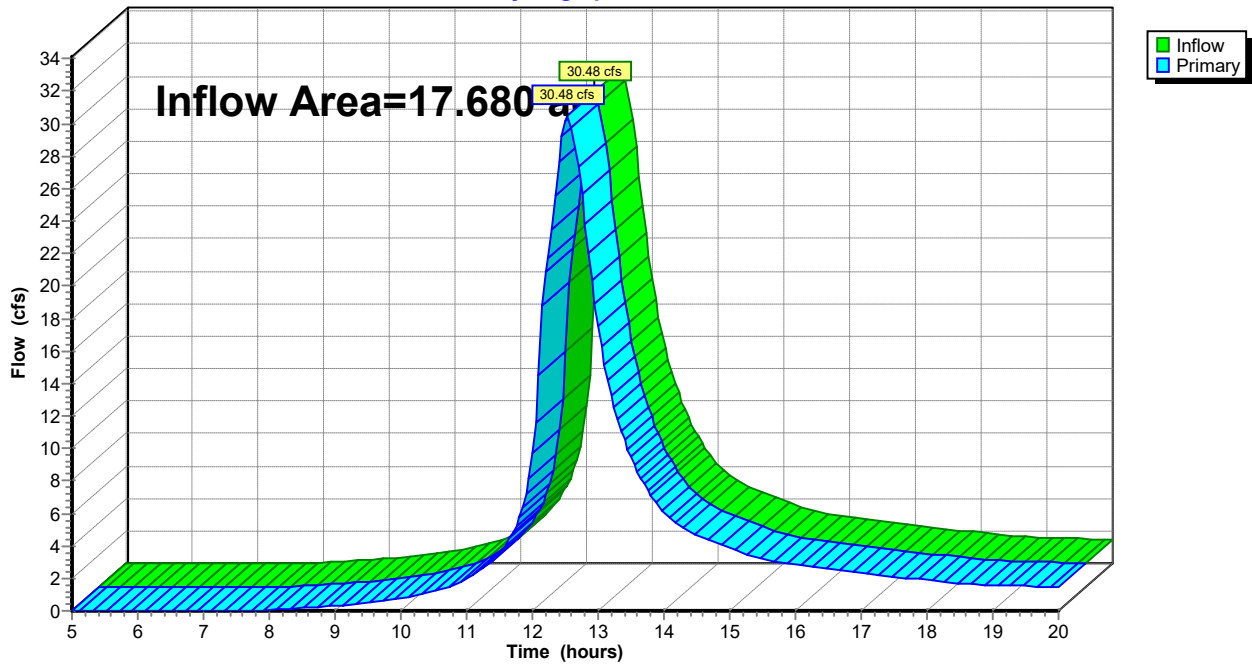

Summary for Link 18L: PR POA / B

Inflow Area = 6.280 ac, 0.00% Impervious, Inflow Depth > 2.33" for 25-Year event
Inflow = 15.14 cfs @ 12.20 hrs, Volume= 1.220 af
Primary = 15.14 cfs @ 12.20 hrs, Volume= 1.220 af, Atten= 0%, Lag= 0.0 min

Primary outflow = Inflow, Time Span= 5.00-20.00 hrs, dt= 0.05 hrs

Link 18L: PR POA / B

Hydrograph

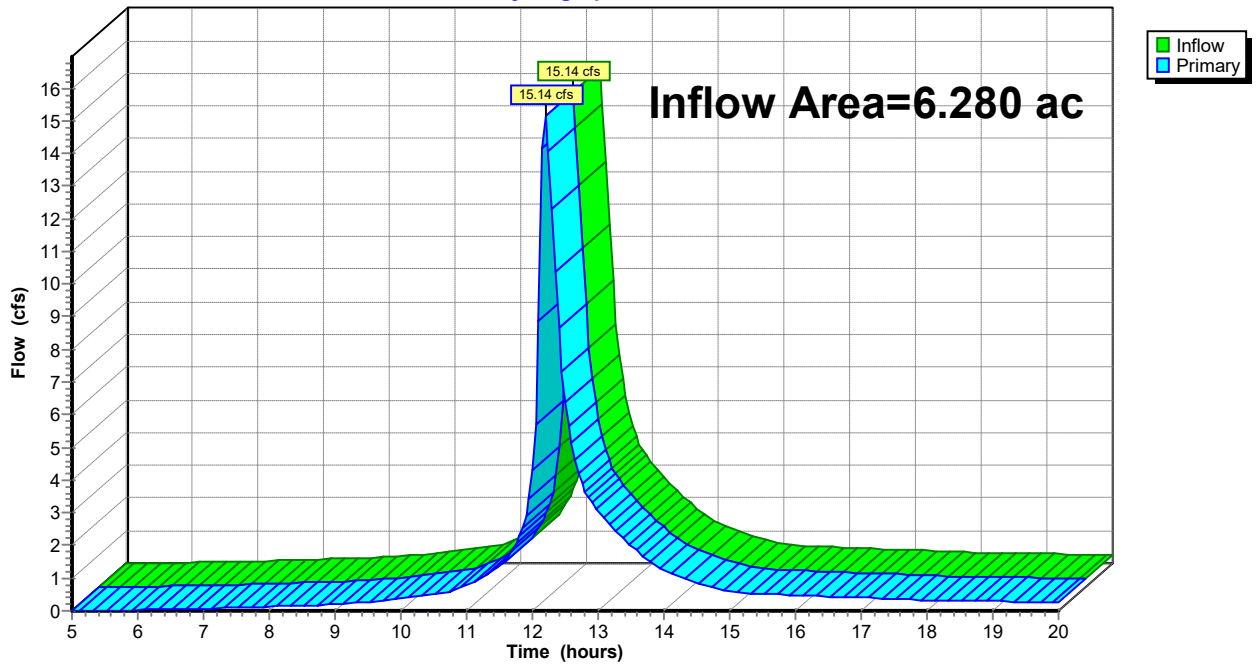

Summary for Subcatchment 1S: EXWS-10

Runoff = 9.63 cfs @ 12.22 hrs, Volume= 0.850 af, Depth> 4.15"
 Routed to Link 4L : EX POA / A

Runoff by SCS TR-20 method, UH=SCS, Weighted-CN, Time Span= 5.00-20.00 hrs, dt= 0.05 hrs
 NOAA 24-hr D 50-Year Rainfall=7.28"

Area (ac)	CN	Description
* 2.460	76	
2.460		100.00% Pervious Area

Tc (min)	Length (feet)	Slope (ft/ft)	Velocity (ft/sec)	Capacity (cfs)	Description
14.2					Direct Entry,

Subcatchment 1S: EXWS-10

Hydrograph

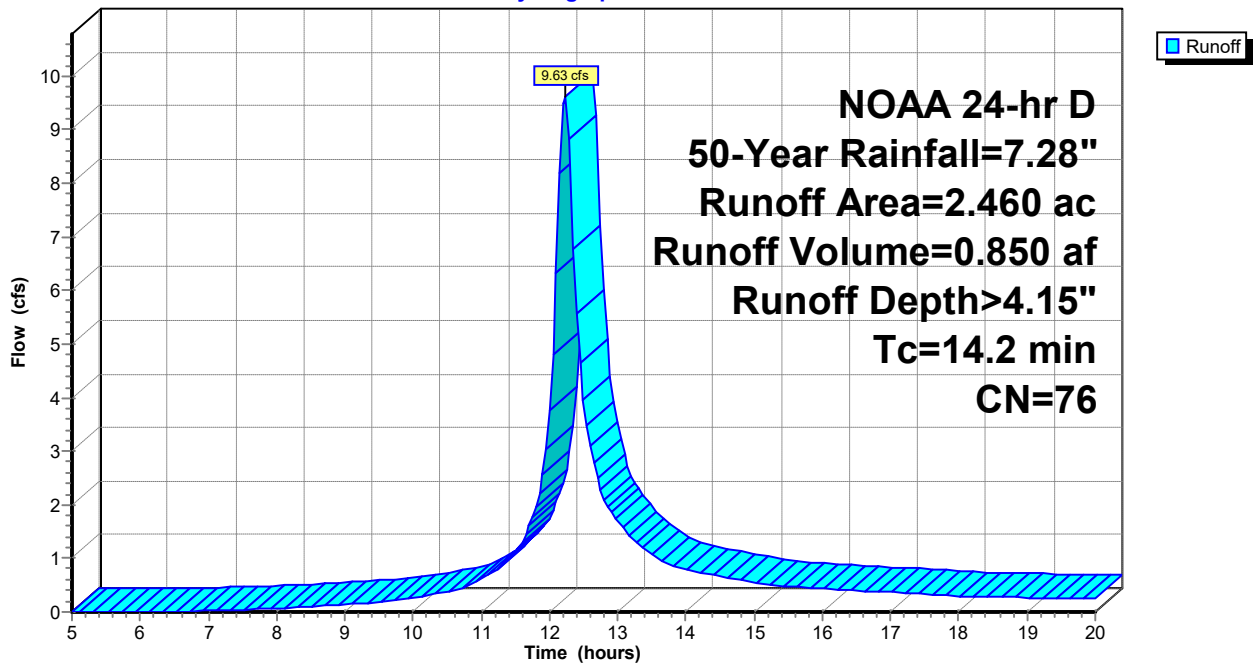

Summary for Subcatchment 2S: EXWS-11

Runoff = 35.03 cfs @ 12.55 hrs, Volume= 4.929 af, Depth> 3.69"
 Routed to Link 4L : EX POA / A

Runoff by SCS TR-20 method, UH=SCS, Weighted-CN, Time Span= 5.00-20.00 hrs, dt= 0.05 hrs
 NOAA 24-hr D 50-Year Rainfall=7.28"

Area (ac)	CN	Description
* 16.050	72	
16.050		100.00% Pervious Area

Tc (min)	Length (feet)	Slope (ft/ft)	Velocity (ft/sec)	Capacity (cfs)	Description
39.6					Direct Entry,

Subcatchment 2S: EXWS-11

Hydrograph

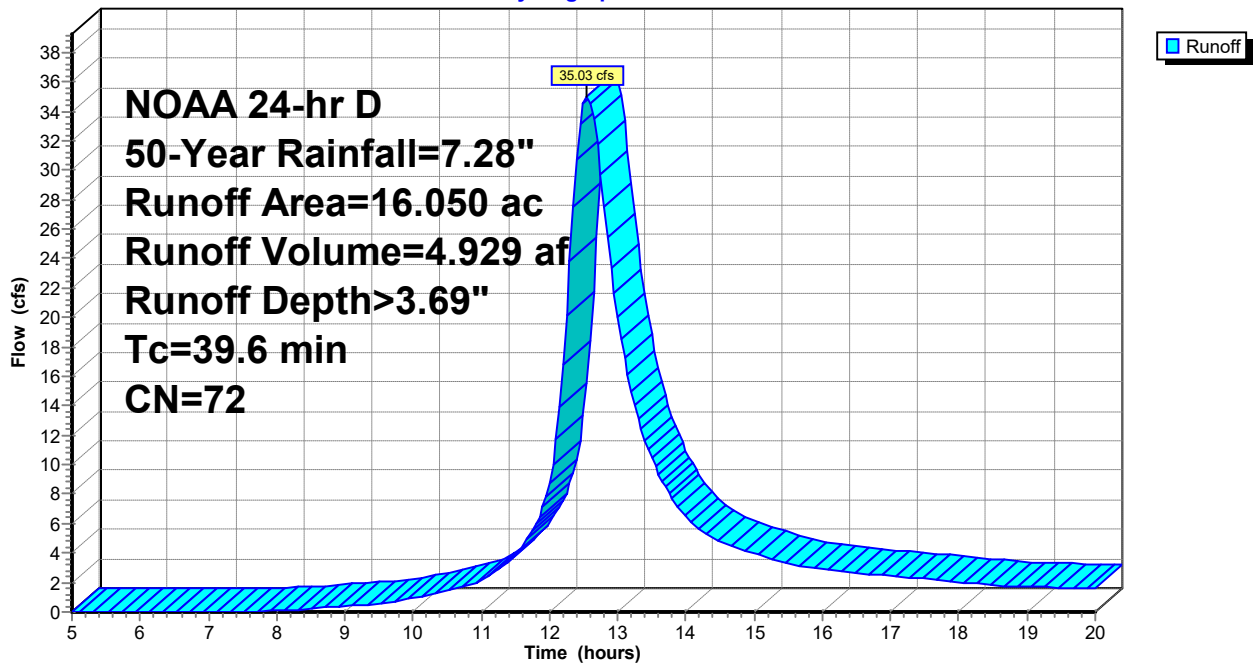

Summary for Subcatchment 5S: EXWS-20 / B

Runoff = 21.24 cfs @ 12.23 hrs, Volume= 1.954 af, Depth> 4.69"

Runoff by SCS TR-20 method, UH=SCS, Weighted-CN, Time Span= 5.00-20.00 hrs, dt= 0.05 hrs
 NOAA 24-hr D 50-Year Rainfall=7.28"

Area (ac)	CN	Description
* 5.000	81	
5.000		100.00% Pervious Area

Tc (min)	Length (feet)	Slope (ft/ft)	Velocity (ft/sec)	Capacity (cfs)	Description
14.9					Direct Entry,

Subcatchment 5S: EXWS-20 / B

Hydrograph

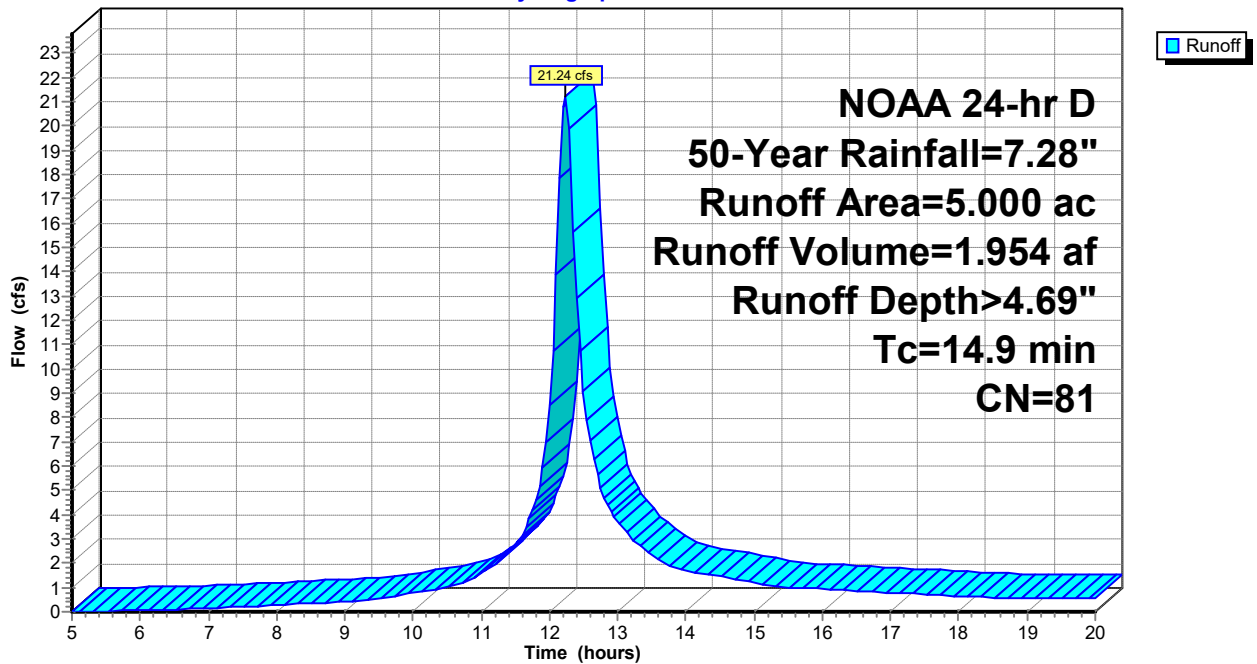

Summary for Subcatchment 6S: EXWS-30 / C

Runoff = 6.75 cfs @ 12.22 hrs, Volume= 0.592 af, Depth> 4.25"

Runoff by SCS TR-20 method, UH=SCS, Weighted-CN, Time Span= 5.00-20.00 hrs, dt= 0.05 hrs
 NOAA 24-hr D 50-Year Rainfall=7.28"

Area (ac)	CN	Description
* 1.670	77	
1.670		100.00% Pervious Area

Tc (min)	Length (feet)	Slope (ft/ft)	Velocity (ft/sec)	Capacity (cfs)	Description
14.0					Direct Entry,

Subcatchment 6S: EXWS-30 / C

Hydrograph

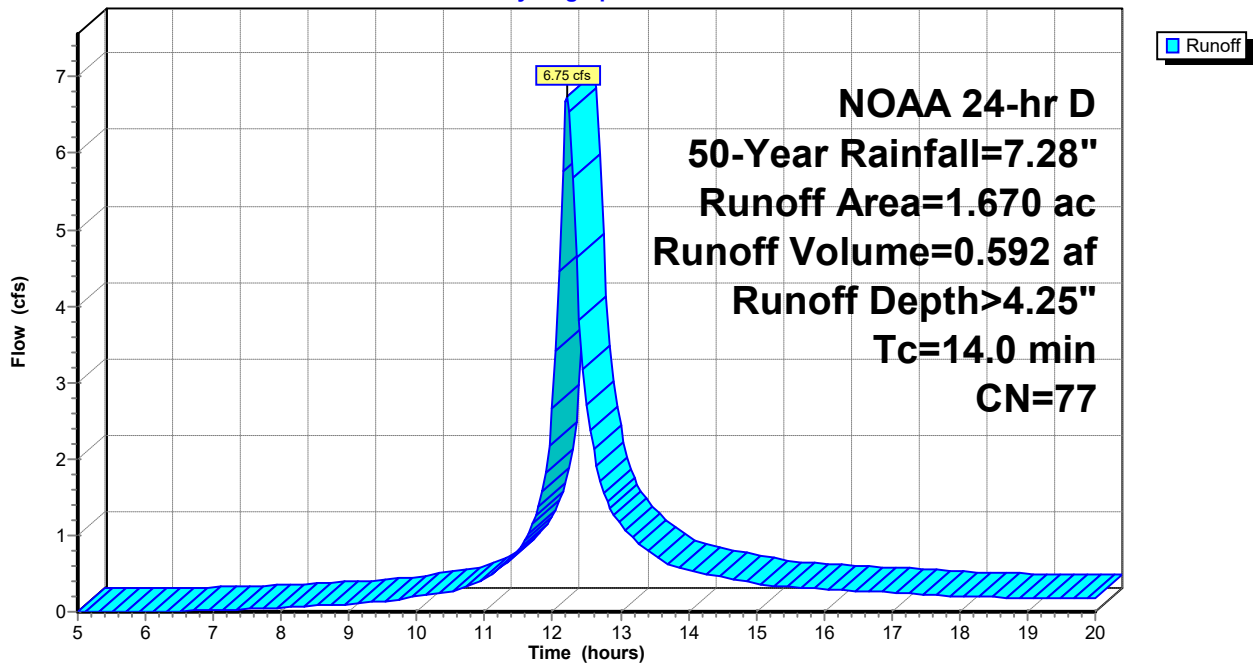

Summary for Subcatchment 7S: PRWS-10

Runoff = 6.38 cfs @ 12.13 hrs, Volume= 0.444 af, Depth> 4.59"
 Routed to Link 15L : PR POA / A

Runoff by SCS TR-20 method, UH=SCS, Weighted-CN, Time Span= 5.00-20.00 hrs, dt= 0.05 hrs
 NOAA 24-hr D 50-Year Rainfall=7.28"

Area (ac)	CN	Description
* 1.160	80	
1.160		100.00% Pervious Area

Tc (min)	Length (feet)	Slope (ft/ft)	Velocity (ft/sec)	Capacity (cfs)	Description
6.0					Direct Entry,

Subcatchment 7S: PRWS-10

Hydrograph

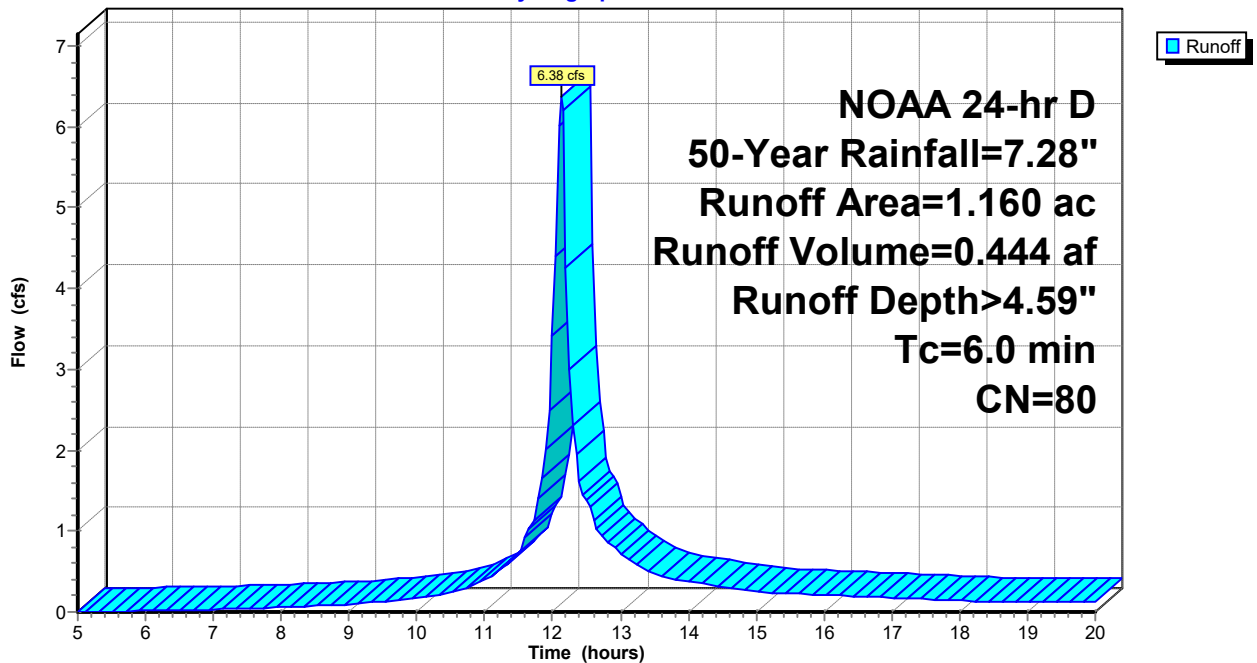

Summary for Subcatchment 8S: PRWS-11

Runoff = 34.81 cfs @ 12.55 hrs, Volume= 4.905 af, Depth> 3.79"
 Routed to Link 15L : PR POA / A

Runoff by SCS TR-20 method, UH=SCS, Weighted-CN, Time Span= 5.00-20.00 hrs, dt= 0.05 hrs
 NOAA 24-hr D 50-Year Rainfall=7.28"

Area (ac)	CN	Description
* 15.530	73	
15.530		100.00% Pervious Area

Tc (min)	Length (feet)	Slope (ft/ft)	Velocity (ft/sec)	Capacity (cfs)	Description
39.6					Direct Entry,

Subcatchment 8S: PRWS-11

Hydrograph

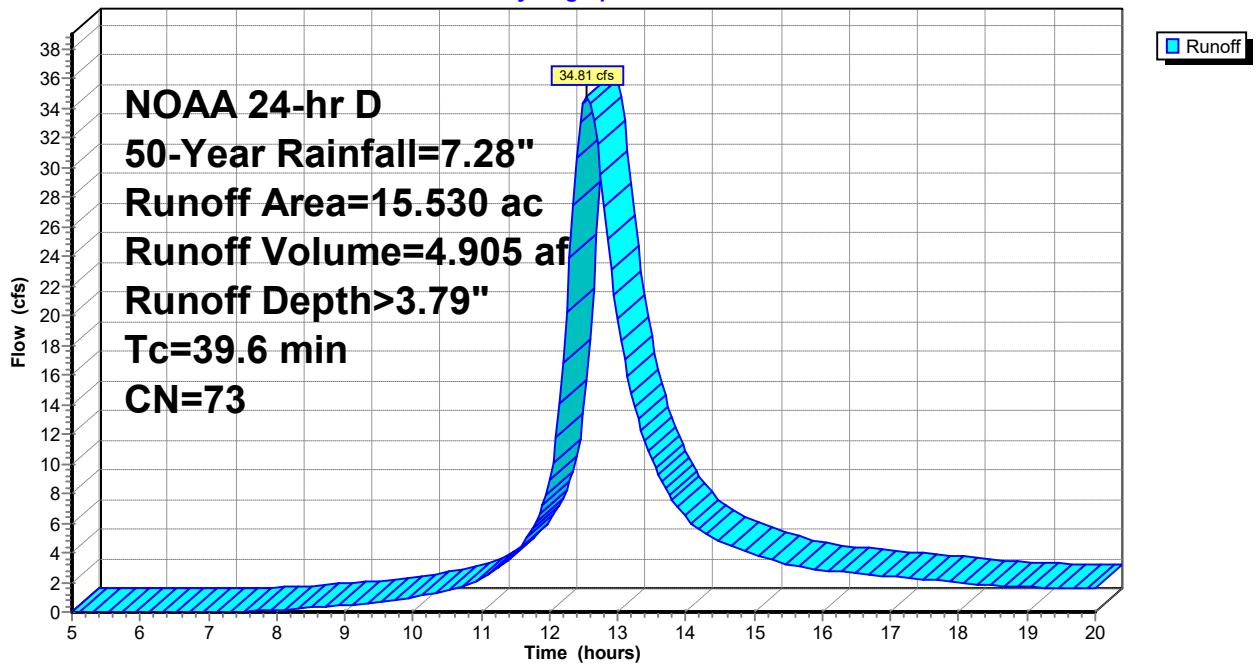

Summary for Subcatchment 9S: PRWS-12

Runoff = 6.01 cfs @ 12.13 hrs, Volume= 0.433 af, Depth> 5.25"
 Routed to Pond 14P : UG 120

Runoff by SCS TR-20 method, UH=SCS, Weighted-CN, Time Span= 5.00-20.00 hrs, dt= 0.05 hrs
 NOAA 24-hr D 50-Year Rainfall=7.28"

Area (ac)	CN	Description
* 0.990	86	
0.990		100.00% Pervious Area

Tc (min)	Length (feet)	Slope (ft/ft)	Velocity (ft/sec)	Capacity (cfs)	Description
6.0					Direct Entry,

Subcatchment 9S: PRWS-12

Hydrograph

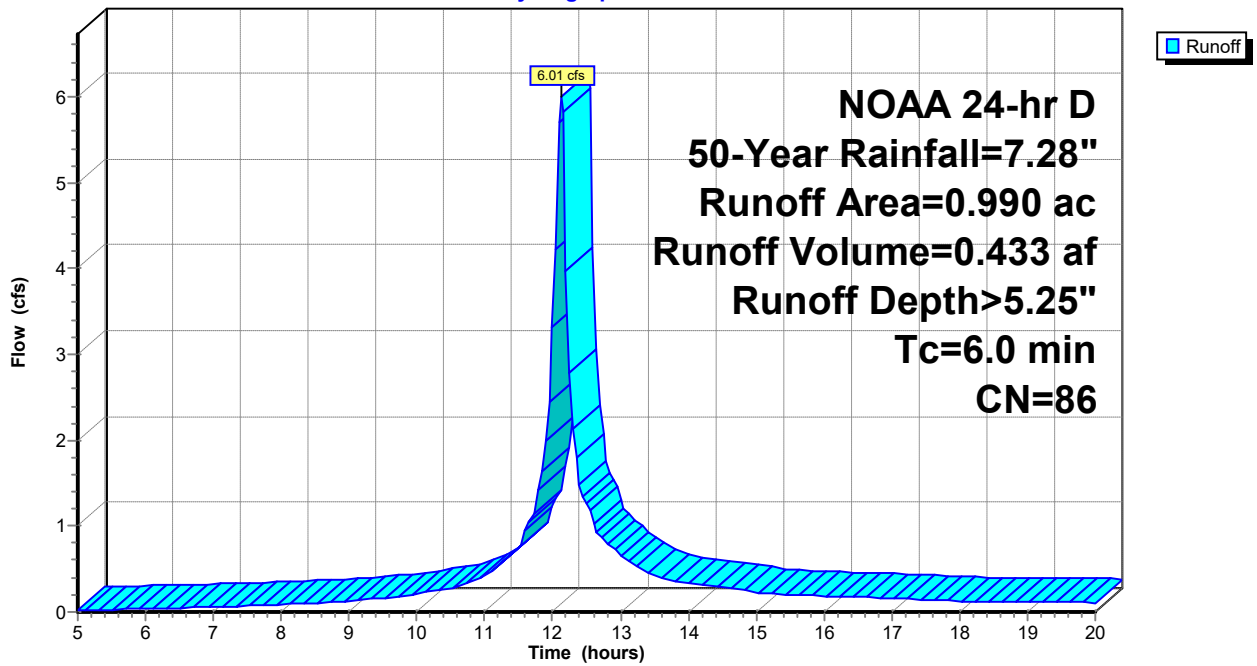

Summary for Subcatchment 10S: PRWS-20

Runoff = 12.61 cfs @ 12.24 hrs, Volume= 1.179 af, Depth> 4.80"
 Routed to Link 18L : PR POA / B

Runoff by SCS TR-20 method, UH=SCS, Weighted-CN, Time Span= 5.00-20.00 hrs, dt= 0.05 hrs
 NOAA 24-hr D 50-Year Rainfall=7.28"

Area (ac)	CN	Description
* 2.950	82	
2.950		100.00% Pervious Area

Tc (min)	Length (feet)	Slope (ft/ft)	Velocity (ft/sec)	Capacity (cfs)	Description
15.4					Direct Entry,

Subcatchment 10S: PRWS-20

Hydrograph

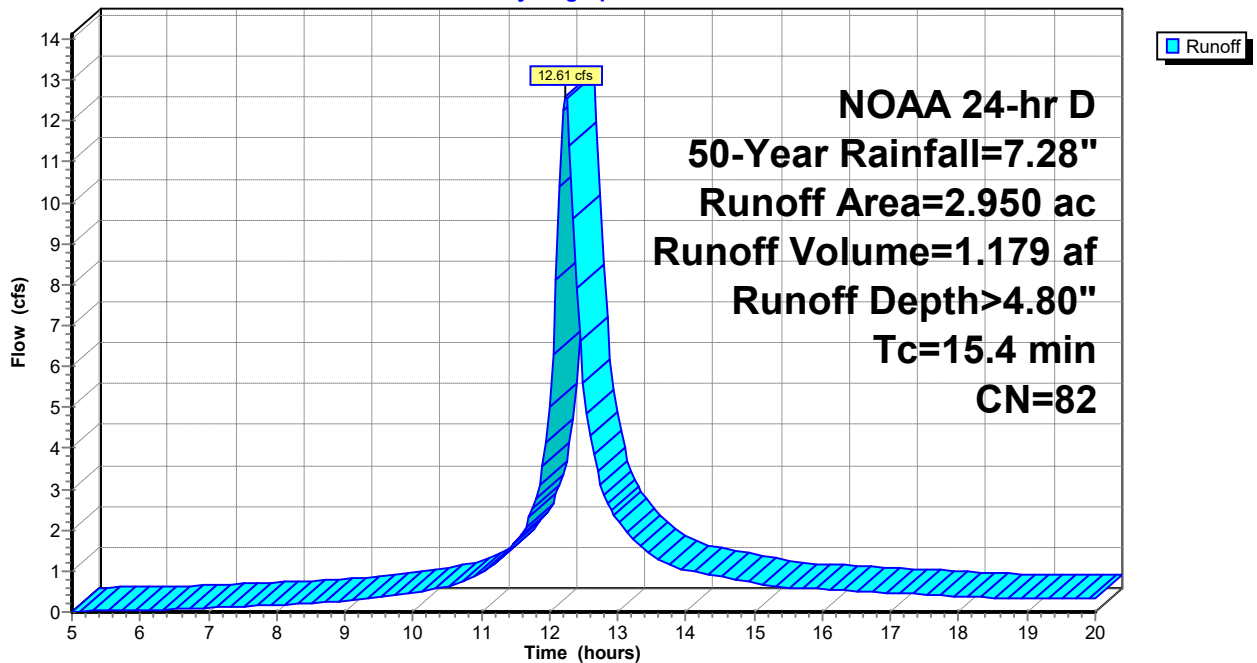

Summary for Subcatchment 11S: PRWS-21

Runoff = 13.59 cfs @ 12.14 hrs, Volume= 1.010 af, Depth> 5.46"
 Routed to Pond 16P : DET 210

Runoff by SCS TR-20 method, UH=SCS, Weighted-CN, Time Span= 5.00-20.00 hrs, dt= 0.05 hrs
 NOAA 24-hr D 50-Year Rainfall=7.28"

Area (ac)	CN	Description
* 2.220	88	
2.220		100.00% Pervious Area

Tc (min)	Length (feet)	Slope (ft/ft)	Velocity (ft/sec)	Capacity (cfs)	Description
6.8					Direct Entry,

Subcatchment 11S: PRWS-21

Hydrograph

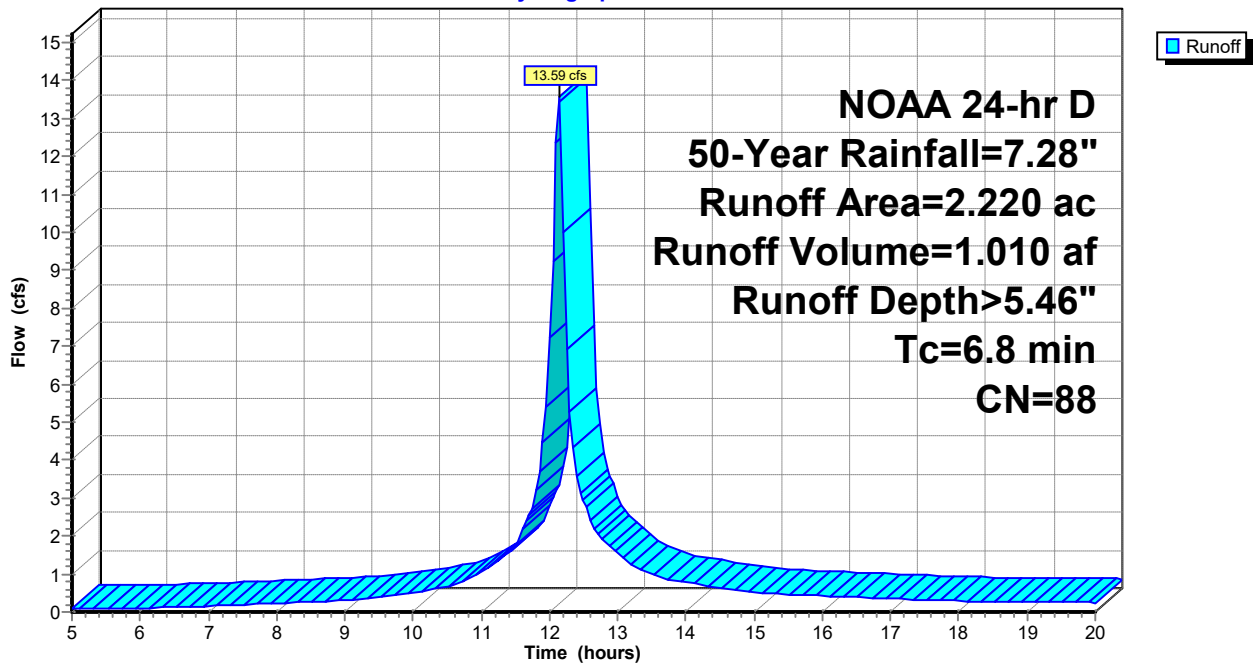

Summary for Subcatchment 12S: PRWS-22

Runoff = 6.91 cfs @ 12.13 hrs, Volume= 0.505 af, Depth> 5.46"
 Routed to Pond 17P : DET 220

Runoff by SCS TR-20 method, UH=SCS, Weighted-CN, Time Span= 5.00-20.00 hrs, dt= 0.05 hrs
 NOAA 24-hr D 50-Year Rainfall=7.28"

Area (ac)	CN	Description
* 1.110	88	
1.110		100.00% Pervious Area

Tc (min)	Length (feet)	Slope (ft/ft)	Velocity (ft/sec)	Capacity (cfs)	Description
6.0					Direct Entry,

Subcatchment 12S: PRWS-22

Hydrograph

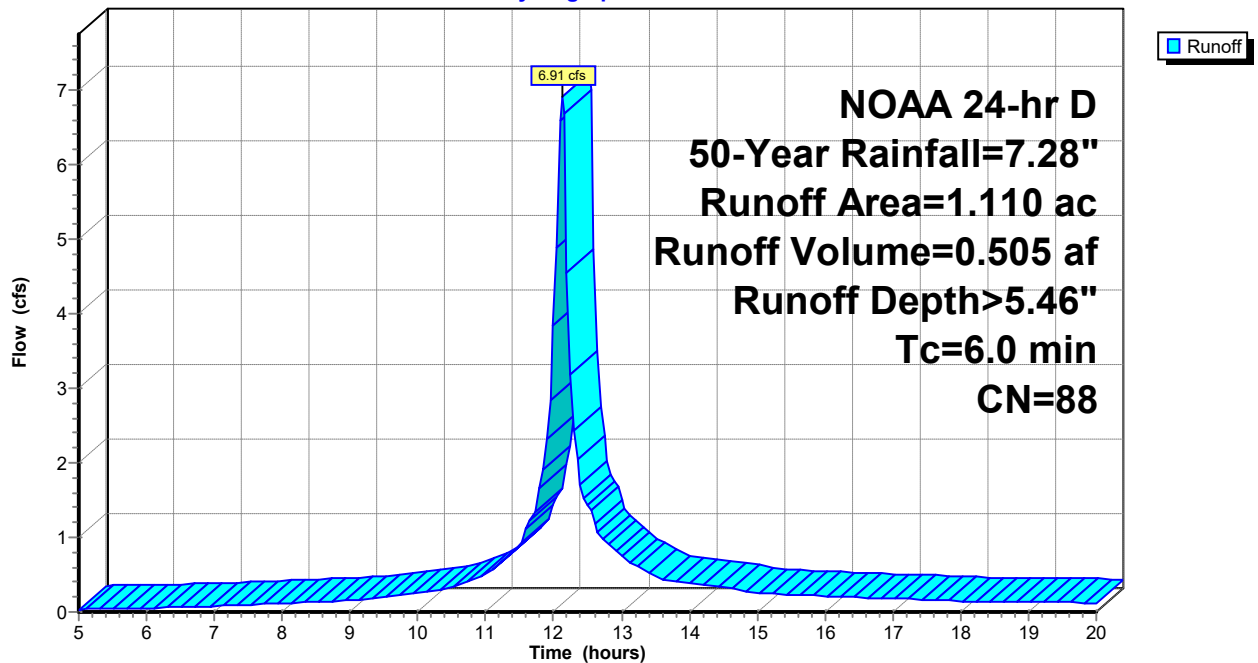

Summary for Subcatchment 13S: PRWS-30 / C

Runoff = 5.65 cfs @ 12.21 hrs, Volume= 0.492 af, Depth> 4.47"

Runoff by SCS TR-20 method, UH=SCS, Weighted-CN, Time Span= 5.00-20.00 hrs, dt= 0.05 hrs
 NOAA 24-hr D 50-Year Rainfall=7.28"

Area (ac)	CN	Description
* 1.320	79	
1.320		100.00% Pervious Area

Tc (min)	Length (feet)	Slope (ft/ft)	Velocity (ft/sec)	Capacity (cfs)	Description
13.4					Direct Entry,

Subcatchment 13S: PRWS-30 / C

Hydrograph

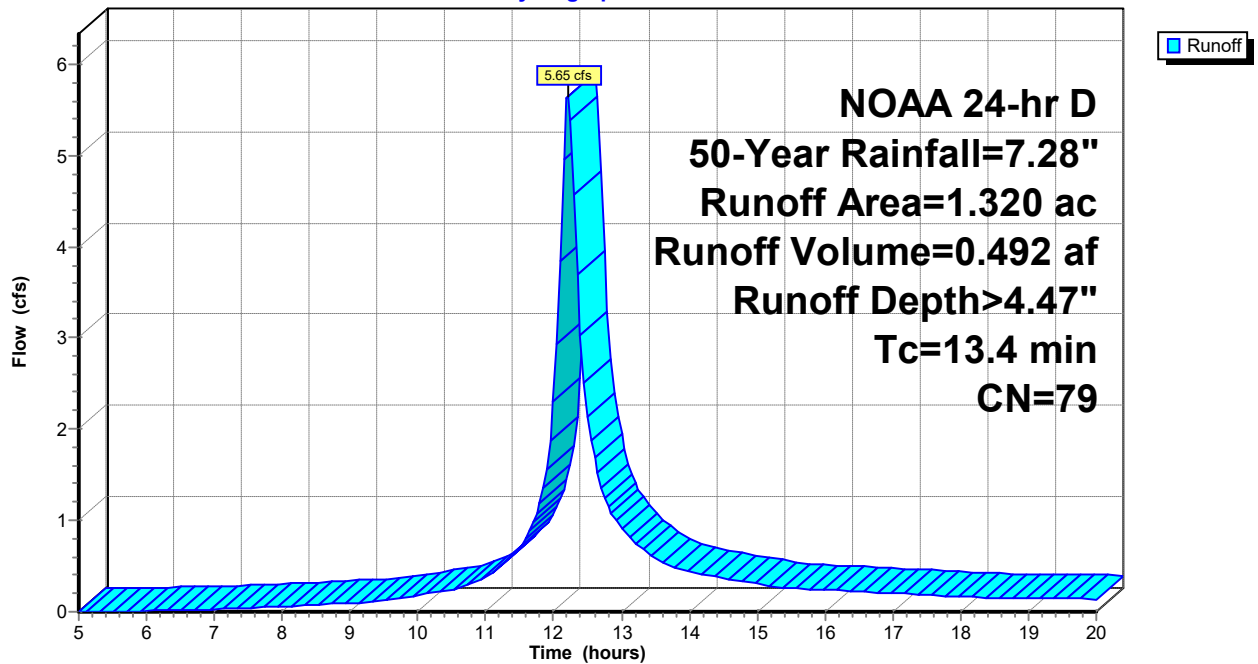

Summary for Pond 14P: UG 120

Inflow Area = 0.990 ac, 0.00% Impervious, Inflow Depth > 5.25" for 50-Year event
 Inflow = 6.01 cfs @ 12.13 hrs, Volume= 0.433 af
 Outflow = 5.33 cfs @ 12.17 hrs, Volume= 0.379 af, Atten= 11%, Lag= 2.6 min
 Discarded = 0.04 cfs @ 6.70 hrs, Volume= 0.045 af
 Primary = 5.30 cfs @ 12.17 hrs, Volume= 0.334 af
 Routed to Pond 19P : PLUNGE POOL 120

Routing by Stor-Ind method, Time Span= 5.00-20.00 hrs, dt= 0.05 hrs
 Peak Elev= 818.54' @ 12.17 hrs Surf.Area= 0.044 ac Storage= 0.137 af

Plug-Flow detention time= 101.2 min calculated for 0.378 af (87% of inflow)
 Center-of-Mass det. time= 60.8 min (821.6 - 760.7)

Volume	Invert	Avail.Storage	Storage Description
#1A	815.00'	0.000 af	24.00'W x 80.00'L x 4.67'H Field A 0.206 af Overall - 0.206 af Embedded = 0.000 af x 40.0% Voids
#2A	815.00'	0.155 af	retain_it retain_it 4.0' x 30 Inside #1 Inside= 84.0"W x 48.0"H => 28.87 sf x 8.00'L = 230.9 cf Outside= 96.0"W x 56.0"H => 37.33 sf x 8.00'L = 298.7 cf 3 Rows adjusted for 196.3 cf perimeter wall
		0.155 af	Total Available Storage

Storage Group A created with Chamber Wizard

Device	Routing	Invert	Outlet Devices
#1	Discarded	815.00'	0.860 in/hr Exfiltration over Surface area
#2	Primary	815.00'	12.0" Round Culvert L= 30.0' CPP, projecting, no headwall, Ke= 0.900 Inlet / Outlet Invert= 815.00' / 814.00' S= 0.0333 '/' Cc= 0.900 n= 0.012, Flow Area= 0.79 sf
#3	Device 2	816.20'	4.0" Vert. Orifice/Grate C= 0.600 Limited to weir flow at low heads
#4	Device 2	818.00'	3.9' long Sharp-Crested Rectangular Weir 2 End Contraction(s)

Discarded OutFlow Max=0.04 cfs @ 6.70 hrs HW=815.05' (Free Discharge)
 ↑ **1=Exfiltration** (Exfiltration Controls 0.04 cfs)

Primary OutFlow Max=5.19 cfs @ 12.17 hrs HW=818.52' (Free Discharge)
 ↑ **2=Culvert** (Inlet Controls 5.19 cfs @ 6.60 fps)
 ↑ **3=Orifice/Grate** (Passes < 0.62 cfs potential flow)
 ↑ **4=Sharp-Crested Rectangular Weir** (Passes < 4.62 cfs potential flow)

Pond 14P: UG 120

Hydrograph

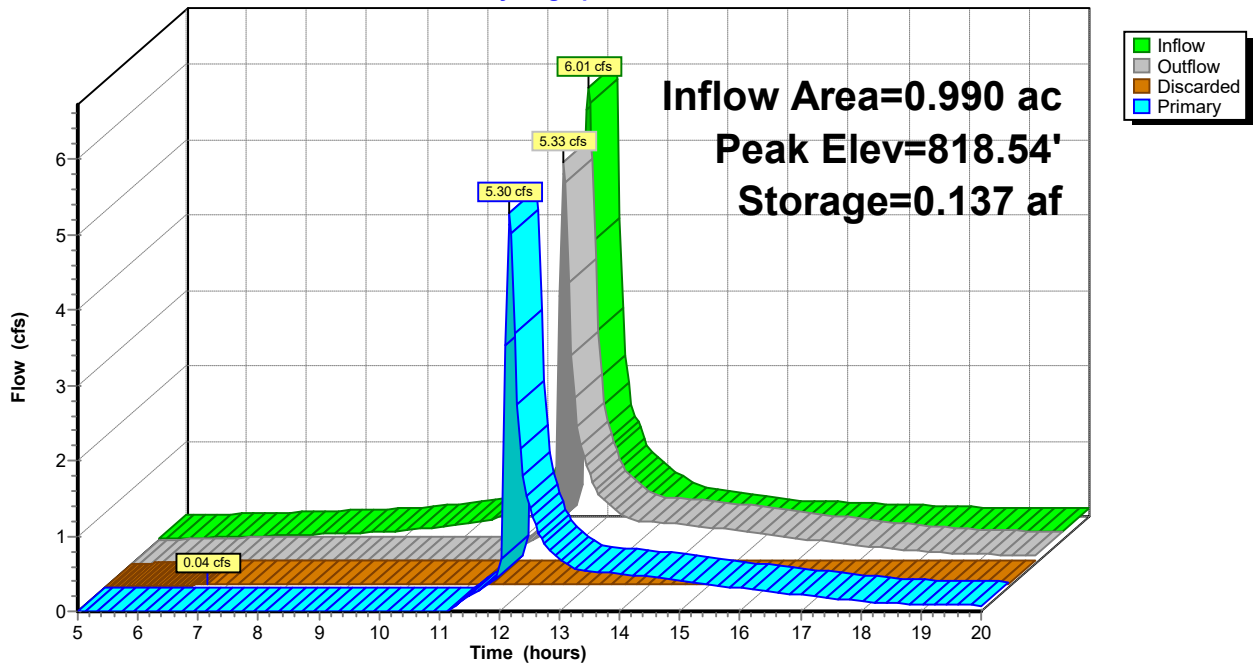

Summary for Pond 16P: DET 210

Inflow Area = 2.220 ac, 0.00% Impervious, Inflow Depth > 5.46" for 50-Year event
 Inflow = 13.59 cfs @ 12.14 hrs, Volume= 1.010 af
 Outflow = 2.30 cfs @ 12.63 hrs, Volume= 1.009 af, Atten= 83%, Lag= 29.4 min
 Discarded = 1.45 cfs @ 12.63 hrs, Volume= 0.863 af
 Primary = 0.85 cfs @ 12.63 hrs, Volume= 0.146 af
 Routed to Link 18L : PR POA / B
 Secondary = 0.00 cfs @ 5.00 hrs, Volume= 0.000 af
 Routed to Link 18L : PR POA / B

Routing by Stor-Ind method, Time Span= 5.00-20.00 hrs, dt= 0.05 hrs
 Peak Elev= 816.65' @ 12.63 hrs Surf.Area= 9,805 sf Storage= 14,327 cf

Plug-Flow detention time= 56.7 min calculated for 1.005 af (100% of inflow)
 Center-of-Mass det. time= 55.9 min (812.7 - 756.8)

Volume	Invert	Avail.Storage	Storage Description	
#1	815.00'	28,806 cf	Custom Stage Data (Conic) Listed below (Recalc)	
Elevation (feet)	Surf.Area (sq-ft)	Inc.Store (cubic-feet)	Cum.Store (cubic-feet)	Wet.Area (sq-ft)
815.00	7,517	0	0	7,517
816.00	8,907	8,202	8,202	8,944
817.00	10,296	9,593	17,795	10,375
818.00	11,741	11,011	28,806	11,867

Device	Routing	Invert	Outlet Devices
#1	Discarded	815.00'	6.400 in/hr Exfiltration over Surface area
#2	Primary	815.00'	12.0" Round Culvert L= 127.0' CPP, projecting, no headwall, Ke= 0.900 Inlet / Outlet Invert= 815.00' / 806.40' S= 0.0677 '/' Cc= 0.900 n= 0.012, Flow Area= 0.79 sf
#3	Device 2	815.60'	6.0" Vert. Orifice/Grate C= 0.600 Limited to weir flow at low heads
#4	Device 2	816.80'	14.0' long Sharp-Crested Rectangular Weir 2 End Contraction(s)
#5	Secondary	817.00'	10.0' long + 3.0 ' SideZ x 8.0' breadth Broad-Crested Rectangular Weir Head (feet) 0.20 0.40 0.60 0.80 1.00 1.20 1.40 1.60 1.80 2.00 2.50 3.00 3.50 4.00 4.50 5.00 5.50 Coef. (English) 2.43 2.54 2.70 2.69 2.68 2.68 2.66 2.64 2.64 2.64 2.65 2.65 2.66 2.66 2.68 2.70 2.74

Discarded OutFlow Max=1.45 cfs @ 12.63 hrs HW=816.65' (Free Discharge)
 ↳1=Exfiltration (Exfiltration Controls 1.45 cfs)

Primary OutFlow Max=0.85 cfs @ 12.63 hrs HW=816.65' (Free Discharge)
 ↳2=Culvert (Passes 0.85 cfs of 3.21 cfs potential flow)
 ↳3=Orifice/Grate (Orifice Controls 0.85 cfs @ 4.32 fps)
 ↳4=Sharp-Crested Rectangular Weir (Controls 0.00 cfs)

Secondary OutFlow Max=0.00 cfs @ 5.00 hrs HW=815.00' (Free Discharge)
 ↳5=Broad-Crested Rectangular Weir (Controls 0.00 cfs)

Pond 16P: DET 210

Hydrograph

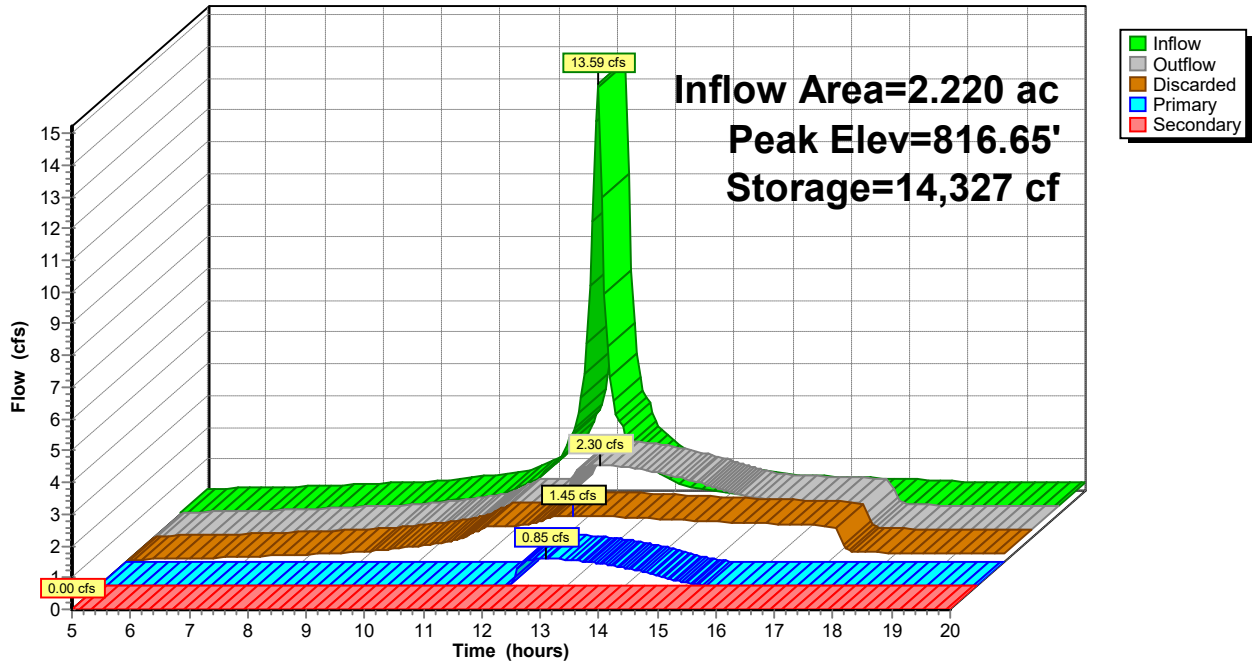

Summary for Pond 17P: DET 220

Inflow Area = 1.110 ac, 0.00% Impervious, Inflow Depth > 5.46" for 50-Year event
 Inflow = 6.91 cfs @ 12.13 hrs, Volume= 0.505 af
 Outflow = 6.54 cfs @ 12.15 hrs, Volume= 0.482 af, Atten= 5%, Lag= 1.4 min
 Discarded = 0.43 cfs @ 12.15 hrs, Volume= 0.287 af
 Primary = 6.11 cfs @ 12.15 hrs, Volume= 0.195 af
 Routed to Link 18L : PR POA / B
 Secondary = 0.00 cfs @ 5.00 hrs, Volume= 0.000 af
 Routed to Link 18L : PR POA / B

Routing by Stor-Ind method, Time Span= 5.00-20.00 hrs, dt= 0.05 hrs
 Peak Elev= 802.85' @ 12.15 hrs Surf.Area= 2,686 sf Storage= 4,881 cf

Plug-Flow detention time= 66.2 min calculated for 0.480 af (95% of inflow)
 Center-of-Mass det. time= 48.0 min (804.1 - 756.2)

Volume	Invert	Avail.Storage	Storage Description		
#1	800.00'	8,875 cf	Custom Stage Data (Conic) Listed below (Recalc)		
Elevation (feet)	Surf.Area (sq-ft)	Inc.Store (cubic-feet)	Cum.Store (cubic-feet)	Wet.Area (sq-ft)	
800.00	879	0	0	879	
801.00	1,441	1,148	1,148	1,454	
802.00	2,039	1,731	2,880	2,070	
803.00	2,810	2,414	5,294	2,860	
804.00	4,412	3,581	8,875	4,476	

Device	Routing	Invert	Outlet Devices
#1	Discarded	800.00'	6.900 in/hr Exfiltration over Surface area
#2	Primary	800.50'	15.0" Round Culvert L= 39.0' CPP, projecting, no headwall, Ke= 0.900 Inlet / Outlet Invert= 800.50' / 800.00' S= 0.0128 '/ Cc= 0.900 n= 0.012, Flow Area= 1.23 sf
#3	Device 2	802.00'	6.0" Vert. Orifice/Grate C= 0.600 Limited to weir flow at low heads
#4	Device 2	802.60'	14.0' long Sharp-Crested Rectangular Weir 2 End Contraction(s)
#5	Secondary	803.00'	10.0' long + 3.0 ' SideZ x 8.0' breadth Broad-Crested Rectangular Weir Head (feet) 0.20 0.40 0.60 0.80 1.00 1.20 1.40 1.60 1.80 2.00 2.50 3.00 3.50 4.00 4.50 5.00 5.50 Coef. (English) 2.43 2.54 2.70 2.69 2.68 2.68 2.66 2.64 2.64 2.64 2.65 2.65 2.66 2.66 2.68 2.70 2.74

Discarded OutFlow Max=0.43 cfs @ 12.15 hrs HW=802.85' (Free Discharge)
 ↑1=Exfiltration (Exfiltration Controls 0.43 cfs)

Primary OutFlow Max=6.13 cfs @ 12.15 hrs HW=802.85' (Free Discharge)
 ↑2=Culvert (Inlet Controls 6.13 cfs @ 4.99 fps)
 ↑3=Orifice/Grate (Passes < 0.73 cfs potential flow)
 ↑4=Sharp-Crested Rectangular Weir (Passes < 5.68 cfs potential flow)

Secondary OutFlow Max=0.00 cfs @ 5.00 hrs HW=800.00' (Free Discharge)
 ↑5=Broad-Crested Rectangular Weir (Controls 0.00 cfs)

Pond 17P: DET 220

Hydrograph

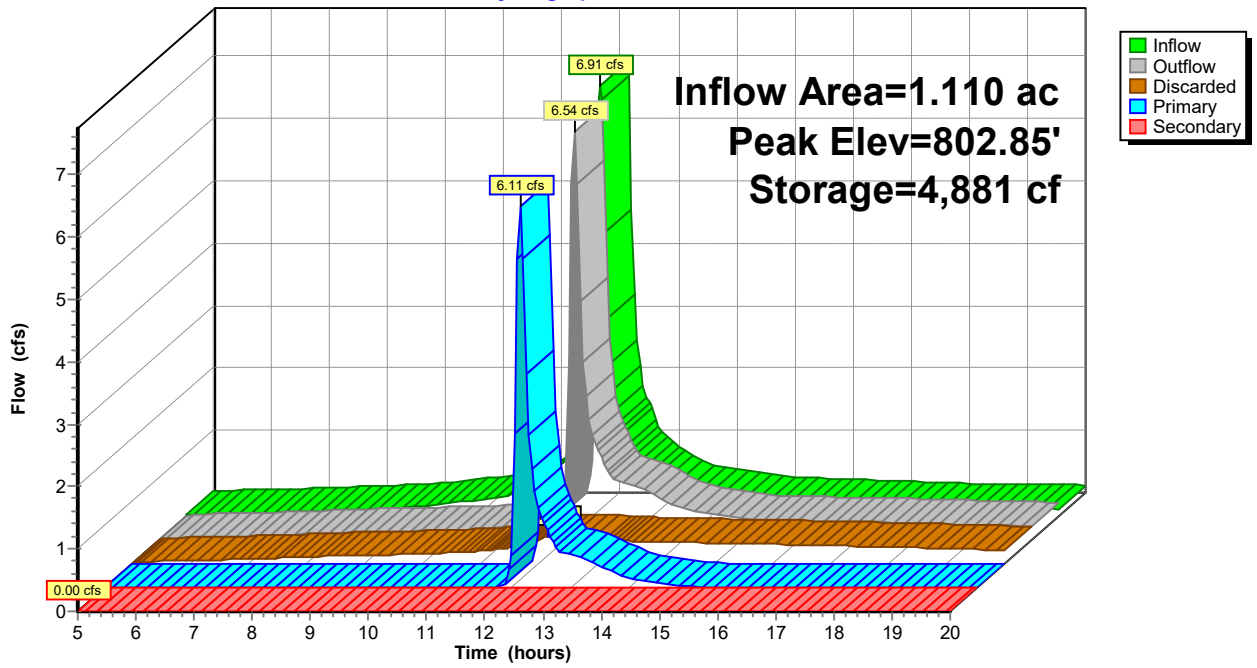

Summary for Pond 19P: PLUNGE POOL 120

Inflow Area = 0.990 ac, 0.00% Impervious, Inflow Depth > 4.05" for 50-Year event
 Inflow = 5.30 cfs @ 12.17 hrs, Volume= 0.334 af
 Outflow = 5.39 cfs @ 12.17 hrs, Volume= 0.323 af, Atten= 0%, Lag= 0.0 min
 Discarded = 0.02 cfs @ 12.17 hrs, Volume= 0.011 af
 Primary = 5.38 cfs @ 12.17 hrs, Volume= 0.312 af
 Routed to Link 15L : PR POA / A

Routing by Stor-Ind method, Time Span= 5.00-20.00 hrs, dt= 0.05 hrs
 Peak Elev= 815.17' @ 12.17 hrs Surf.Area= 845 sf Storage= 622 cf

Plug-Flow detention time= 16.1 min calculated for 0.322 af (96% of inflow)
 Center-of-Mass det. time= 5.1 min (833.3 - 828.1)

Volume	Invert	Avail.Storage	Storage Description
#1	814.00'	1,517 cf	Custom Stage Data (Prismatic) Listed below (Recalc)
Elevation (feet)	Surf.Area (sq-ft)	Inc.Store (cubic-feet)	Cum.Store (cubic-feet)
814.00	223	0	0
815.00	744	484	484
816.00	1,322	1,033	1,517

Device	Routing	Invert	Outlet Devices
#1	Discarded	814.00'	0.860 in/hr Exfiltration over Surface area
#2	Primary	815.00'	30.0' long + 3.0 ' SideZ x 8.0' breadth Broad-Crested Rectangular Weir
Head (feet) 0.20 0.40 0.60 0.80 1.00 1.20 1.40 1.60 1.80			
2.00 2.50 3.00 3.50 4.00 4.50 5.00 5.50			
Coef. (English) 2.43 2.54 2.70 2.69 2.68 2.68 2.66 2.64 2.64			
2.64 2.65 2.65 2.66 2.66 2.68 2.70 2.74			

Discarded OutFlow Max=0.02 cfs @ 12.17 hrs HW=815.17' (Free Discharge)
 ↑1=Exfiltration (Exfiltration Controls 0.02 cfs)

Primary OutFlow Max=5.08 cfs @ 12.17 hrs HW=815.17' (Free Discharge)
 ↑2=Broad-Crested Rectangular Weir (Weir Controls 5.08 cfs @ 0.99 fps)

Pond 19P: PLUNGE POOL 120

Hydrograph

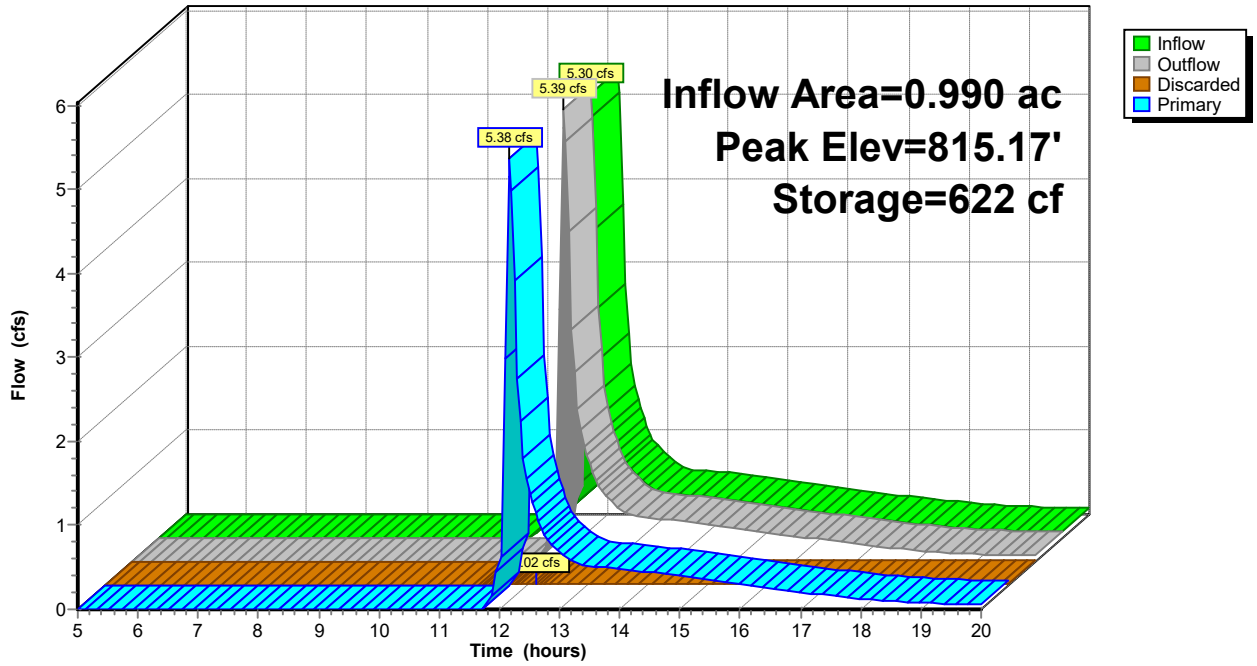

Summary for Link 4L: EX POA / A

Inflow Area = 18.510 ac, 0.00% Impervious, Inflow Depth > 3.75" for 50-Year event
Inflow = 38.59 cfs @ 12.52 hrs, Volume= 5.779 af
Primary = 38.59 cfs @ 12.52 hrs, Volume= 5.779 af, Atten= 0%, Lag= 0.0 min

Primary outflow = Inflow, Time Span= 5.00-20.00 hrs, dt= 0.05 hrs

Link 4L: EX POA / A

Hydrograph

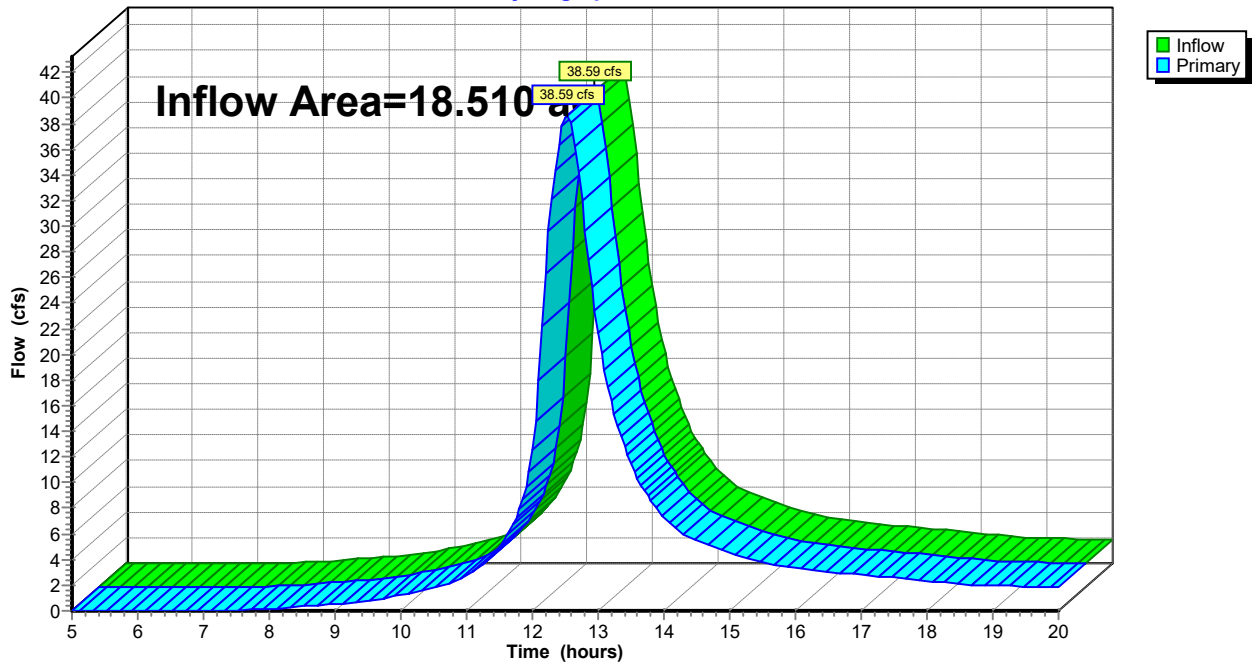

Summary for Link 15L: PR POA / A

Inflow Area = 17.680 ac, 0.00% Impervious, Inflow Depth > 3.84" for 50-Year event
Inflow = 37.40 cfs @ 12.54 hrs, Volume= 5.661 af
Primary = 37.40 cfs @ 12.54 hrs, Volume= 5.661 af, Atten= 0%, Lag= 0.0 min

Primary outflow = Inflow, Time Span= 5.00-20.00 hrs, dt= 0.05 hrs

Link 15L: PR POA / A

Hydrograph

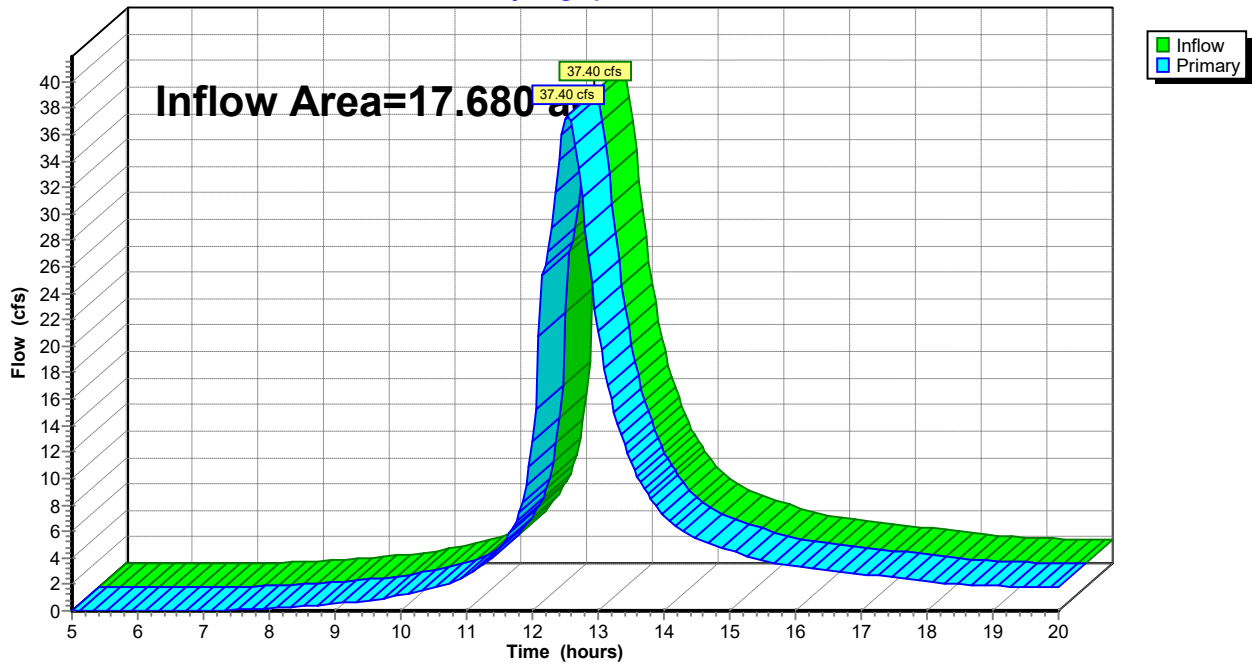

Summary for Link 18L: PR POA / B

Inflow Area = 6.280 ac, 0.00% Impervious, Inflow Depth > 2.90" for 50-Year event
Inflow = 18.19 cfs @ 12.20 hrs, Volume= 1.520 af
Primary = 18.19 cfs @ 12.20 hrs, Volume= 1.520 af, Atten= 0%, Lag= 0.0 min

Primary outflow = Inflow, Time Span= 5.00-20.00 hrs, dt= 0.05 hrs

Link 18L: PR POA / B

Hydrograph

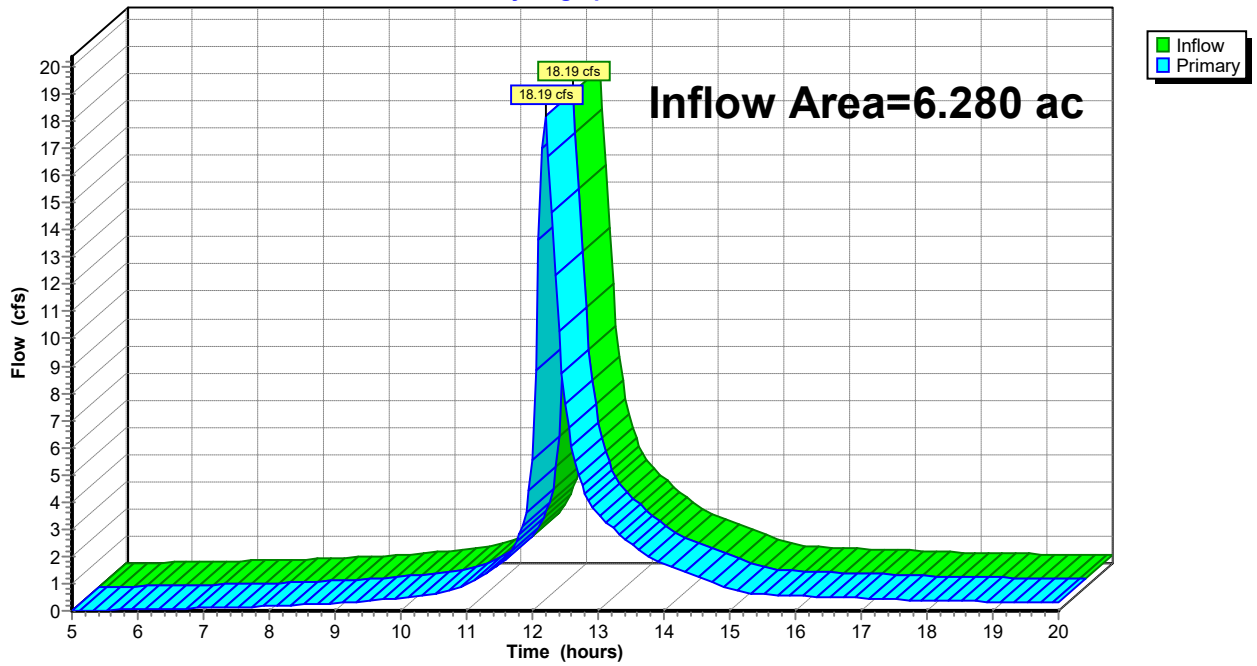

Summary for Subcatchment 1S: EXWS-10

Runoff = 11.59 cfs @ 12.22 hrs, Volume= 1.031 af, Depth> 5.03"
 Routed to Link 4L : EX POA / A

Runoff by SCS TR-20 method, UH=SCS, Weighted-CN, Time Span= 5.00-20.00 hrs, dt= 0.05 hrs
 NOAA 24-hr D 100-Year Rainfall=8.32"

Area (ac)	CN	Description
* 2.460	76	
2.460		100.00% Pervious Area

Tc (min)	Length (feet)	Slope (ft/ft)	Velocity (ft/sec)	Capacity (cfs)	Description
14.2					Direct Entry,

Subcatchment 1S: EXWS-10

Hydrograph

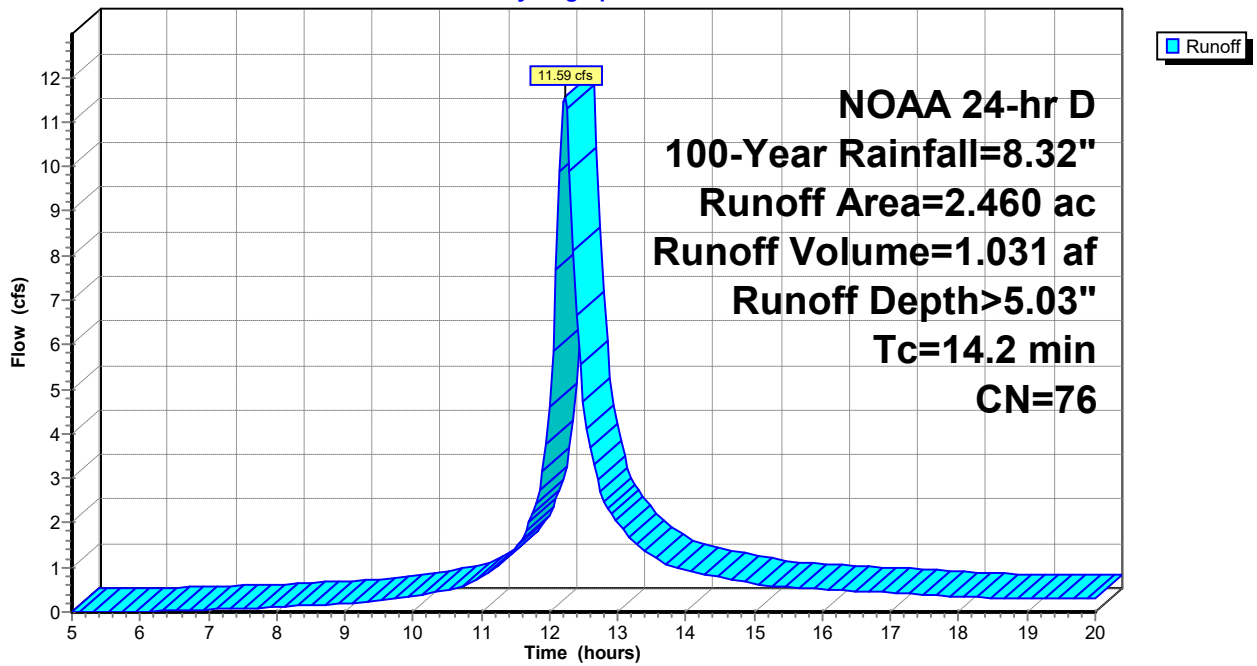

Summary for Subcatchment 2S: EXWS-11

Runoff = 42.83 cfs @ 12.55 hrs, Volume= 6.052 af, Depth> 4.53"
Routed to Link 4L : EX POA / A

Runoff by SCS TR-20 method, UH=SCS, Weighted-CN, Time Span= 5.00-20.00 hrs, dt= 0.05 hrs
NOAA 24-hr D 100-Year Rainfall=8.32"

Area (ac)	CN	Description
* 16.050	72	
16.050		100.00% Pervious Area

Tc (min)	Length (feet)	Slope (ft/ft)	Velocity (ft/sec)	Capacity (cfs)	Description
39.6					Direct Entry,

Subcatchment 2S: EXWS-11

Hydrograph

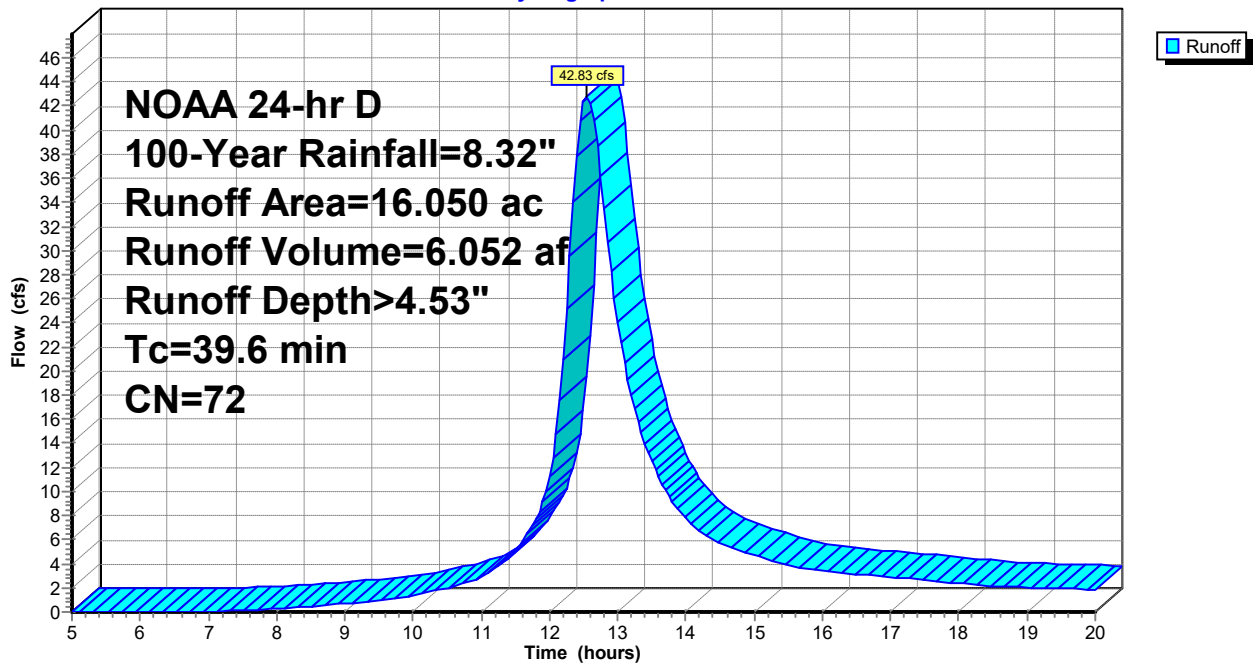

Summary for Subcatchment 5S: EXWS-20 / B

Runoff = 25.15 cfs @ 12.23 hrs, Volume= 2.336 af, Depth> 5.61"

Runoff by SCS TR-20 method, UH=SCS, Weighted-CN, Time Span= 5.00-20.00 hrs, dt= 0.05 hrs
 NOAA 24-hr D 100-Year Rainfall=8.32"

Area (ac)	CN	Description
* 5.000	81	
5.000		100.00% Pervious Area

Tc (min)	Length (feet)	Slope (ft/ft)	Velocity (ft/sec)	Capacity (cfs)	Description
14.9					Direct Entry,

Subcatchment 5S: EXWS-20 / B

Hydrograph

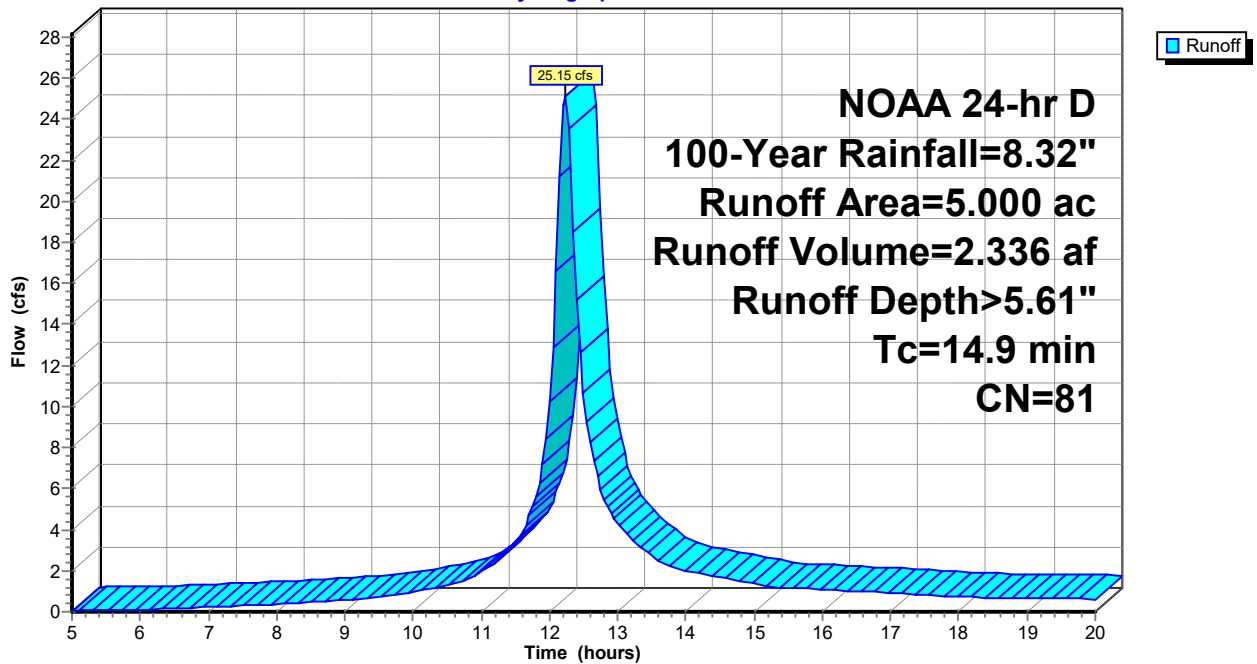

Summary for Subcatchment 6S: EXWS-30 / C

Runoff = 8.09 cfs @ 12.22 hrs, Volume= 0.716 af, Depth> 5.15"

Runoff by SCS TR-20 method, UH=SCS, Weighted-CN, Time Span= 5.00-20.00 hrs, dt= 0.05 hrs
 NOAA 24-hr D 100-Year Rainfall=8.32"

Area (ac)	CN	Description
* 1.670	77	
1.670		100.00% Pervious Area

Tc (min)	Length (feet)	Slope (ft/ft)	Velocity (ft/sec)	Capacity (cfs)	Description
14.0					Direct Entry,

Subcatchment 6S: EXWS-30 / C

Hydrograph

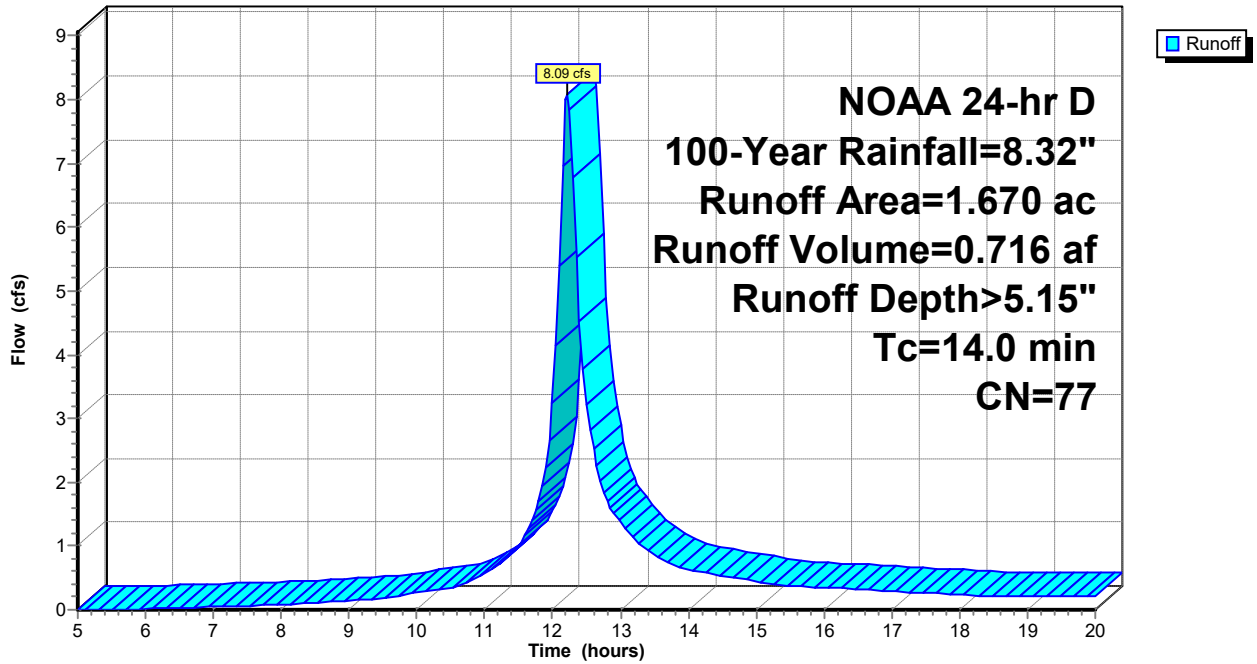

Summary for Subcatchment 7S: PRWS-10

Runoff = 7.56 cfs @ 12.13 hrs, Volume= 0.532 af, Depth> 5.51"
Routed to Link 15L : PR POA / A

Runoff by SCS TR-20 method, UH=SCS, Weighted-CN, Time Span= 5.00-20.00 hrs, dt= 0.05 hrs
NOAA 24-hr D 100-Year Rainfall=8.32"

Area (ac)	CN	Description
* 1.160	80	
1.160		100.00% Pervious Area

Tc (min)	Length (feet)	Slope (ft/ft)	Velocity (ft/sec)	Capacity (cfs)	Description
6.0					Direct Entry,

Subcatchment 7S: PRWS-10

Hydrograph

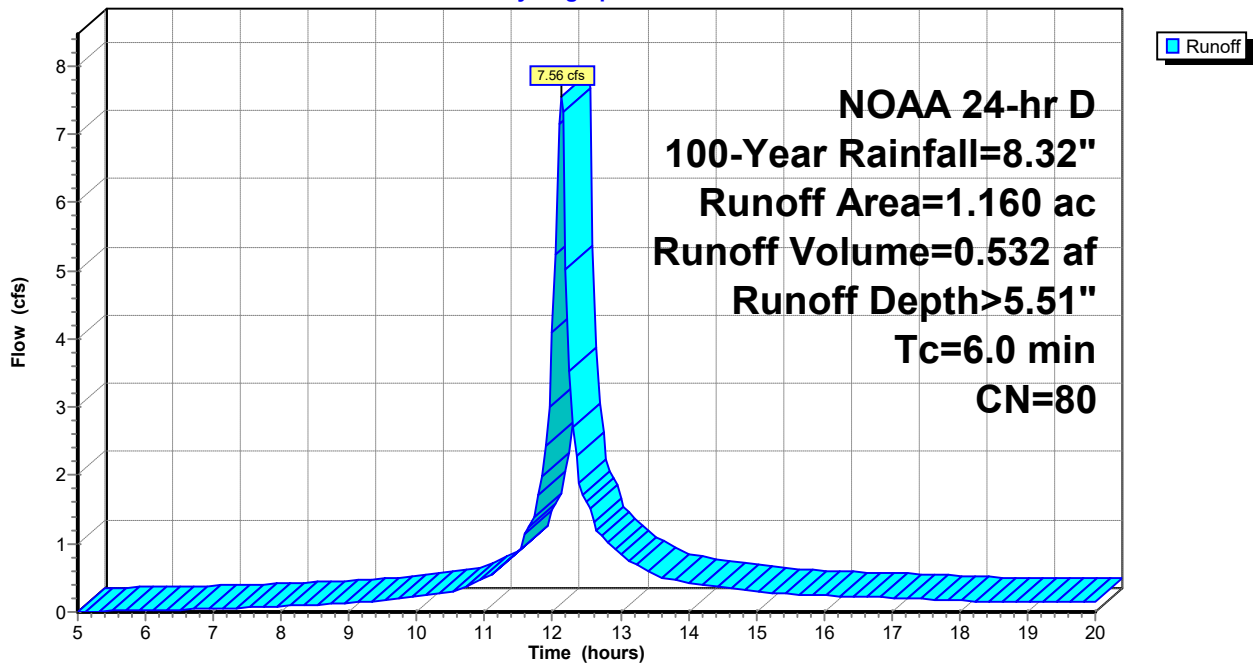

Summary for Subcatchment 8S: PRWS-11

Runoff = 42.40 cfs @ 12.55 hrs, Volume= 6.004 af, Depth> 4.64"
 Routed to Link 15L : PR POA / A

Runoff by SCS TR-20 method, UH=SCS, Weighted-CN, Time Span= 5.00-20.00 hrs, dt= 0.05 hrs
 NOAA 24-hr D 100-Year Rainfall=8.32"

Area (ac)	CN	Description
* 15.530	73	
15.530		100.00% Pervious Area

Tc (min)	Length (feet)	Slope (ft/ft)	Velocity (ft/sec)	Capacity (cfs)	Description
39.6					Direct Entry,

Subcatchment 8S: PRWS-11

Hydrograph

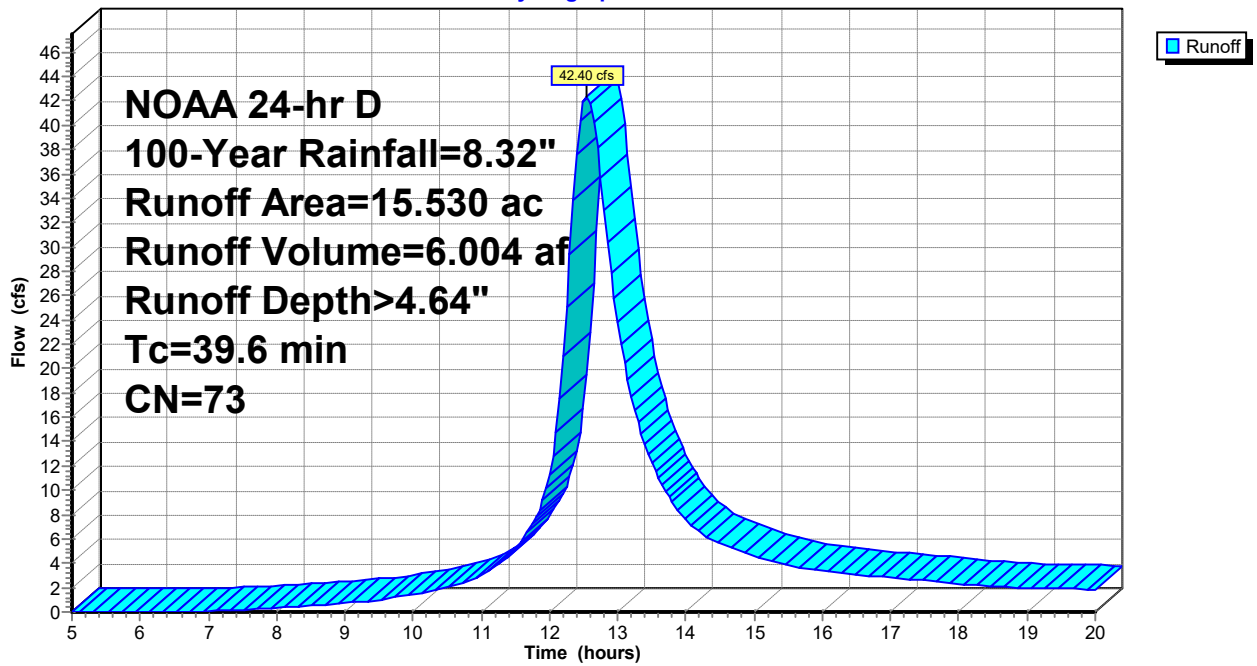

Summary for Subcatchment 9S: PRWS-12

Runoff = 7.01 cfs @ 12.13 hrs, Volume= 0.510 af, Depth> 6.18"
 Routed to Pond 14P : UG 120

Runoff by SCS TR-20 method, UH=SCS, Weighted-CN, Time Span= 5.00-20.00 hrs, dt= 0.05 hrs
 NOAA 24-hr D 100-Year Rainfall=8.32"

Area (ac)	CN	Description
* 0.990	86	
0.990		100.00% Pervious Area

Tc (min)	Length (feet)	Slope (ft/ft)	Velocity (ft/sec)	Capacity (cfs)	Description
6.0					Direct Entry,

Subcatchment 9S: PRWS-12

Hydrograph

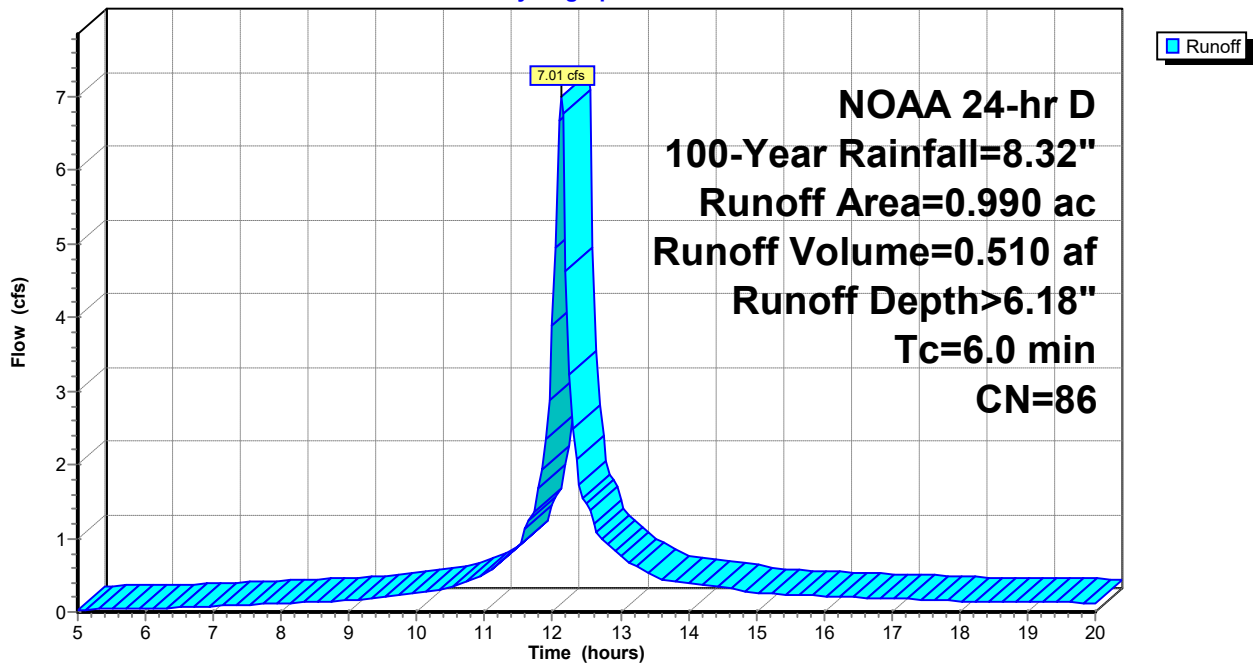

Summary for Subcatchment 10S: PRWS-20

Runoff = 14.89 cfs @ 12.23 hrs, Volume= 1.406 af, Depth> 5.72"
 Routed to Link 18L : PR POA / B

Runoff by SCS TR-20 method, UH=SCS, Weighted-CN, Time Span= 5.00-20.00 hrs, dt= 0.05 hrs
 NOAA 24-hr D 100-Year Rainfall=8.32"

Area (ac)	CN	Description
* 2.950	82	
2.950		100.00% Pervious Area

Tc (min)	Length (feet)	Slope (ft/ft)	Velocity (ft/sec)	Capacity (cfs)	Description
15.4					Direct Entry,

Subcatchment 10S: PRWS-20

Hydrograph

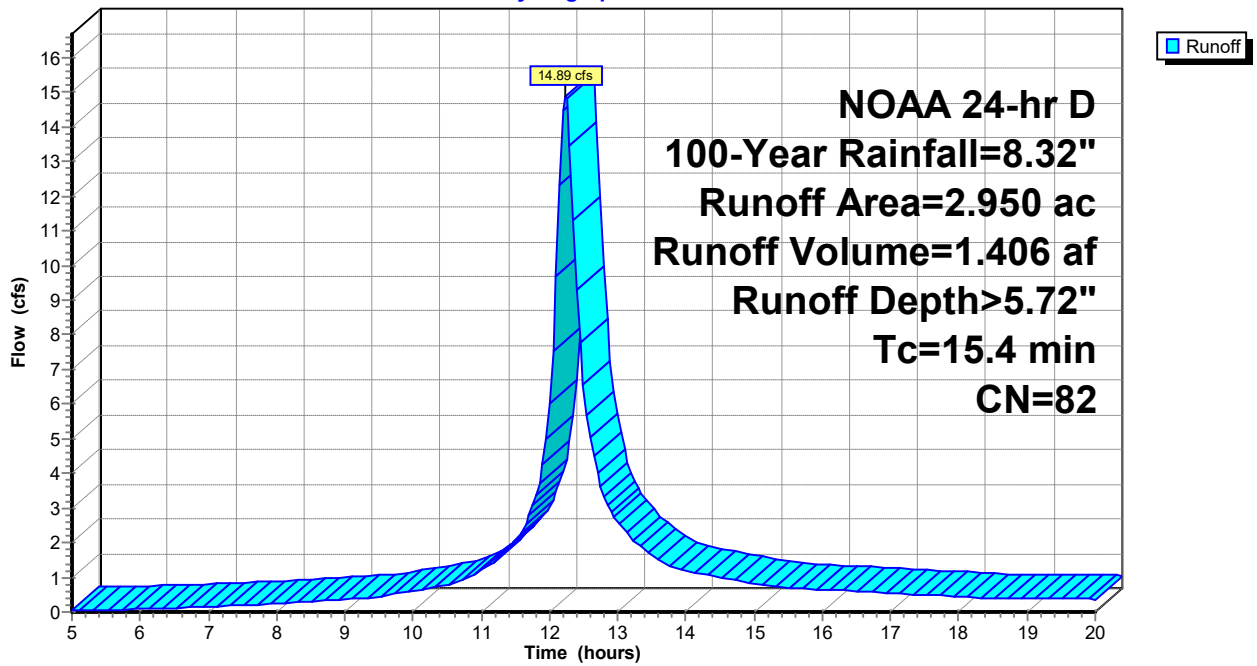

Summary for Subcatchment 11S: PRWS-21

Runoff = 15.78 cfs @ 12.14 hrs, Volume= 1.183 af, Depth> 6.40"
 Routed to Pond 16P : DET 210

Runoff by SCS TR-20 method, UH=SCS, Weighted-CN, Time Span= 5.00-20.00 hrs, dt= 0.05 hrs
 NOAA 24-hr D 100-Year Rainfall=8.32"

Area (ac)	CN	Description
* 2.220	88	
2.220		100.00% Pervious Area

Tc (min)	Length (feet)	Slope (ft/ft)	Velocity (ft/sec)	Capacity (cfs)	Description
6.8					Direct Entry,

Subcatchment 11S: PRWS-21

Hydrograph

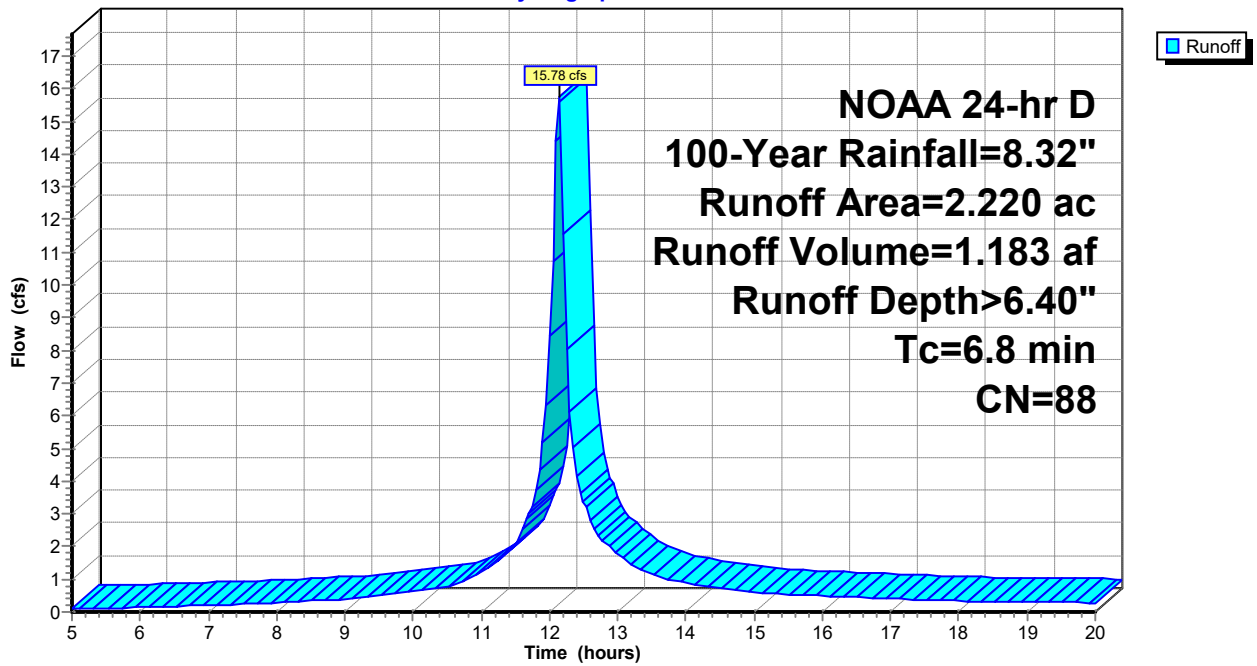

Summary for Subcatchment 12S: PRWS-22

Runoff = 8.03 cfs @ 12.13 hrs, Volume= 0.592 af, Depth> 6.40"
 Routed to Pond 17P : DET 220

Runoff by SCS TR-20 method, UH=SCS, Weighted-CN, Time Span= 5.00-20.00 hrs, dt= 0.05 hrs
 NOAA 24-hr D 100-Year Rainfall=8.32"

Area (ac)	CN	Description
* 1.110	88	
1.110		100.00% Pervious Area

Tc (min)	Length (feet)	Slope (ft/ft)	Velocity (ft/sec)	Capacity (cfs)	Description
6.0					Direct Entry,

Subcatchment 12S: PRWS-22

Hydrograph

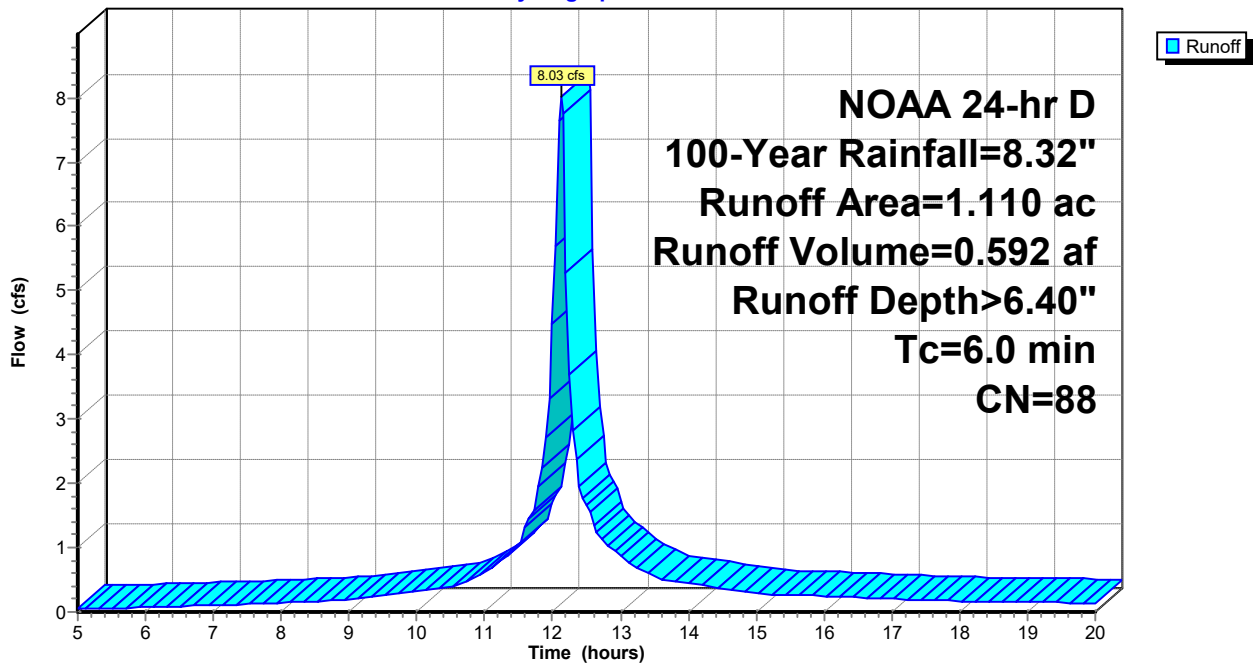

Summary for Subcatchment 13S: PRWS-30 / C

Runoff = 6.73 cfs @ 12.21 hrs, Volume= 0.592 af, Depth> 5.38"

Runoff by SCS TR-20 method, UH=SCS, Weighted-CN, Time Span= 5.00-20.00 hrs, dt= 0.05 hrs
 NOAA 24-hr D 100-Year Rainfall=8.32"

Area (ac)	CN	Description
* 1.320	79	
1.320		100.00% Pervious Area

Tc (min)	Length (feet)	Slope (ft/ft)	Velocity (ft/sec)	Capacity (cfs)	Description
13.4					Direct Entry,

Subcatchment 13S: PRWS-30 / C

Hydrograph

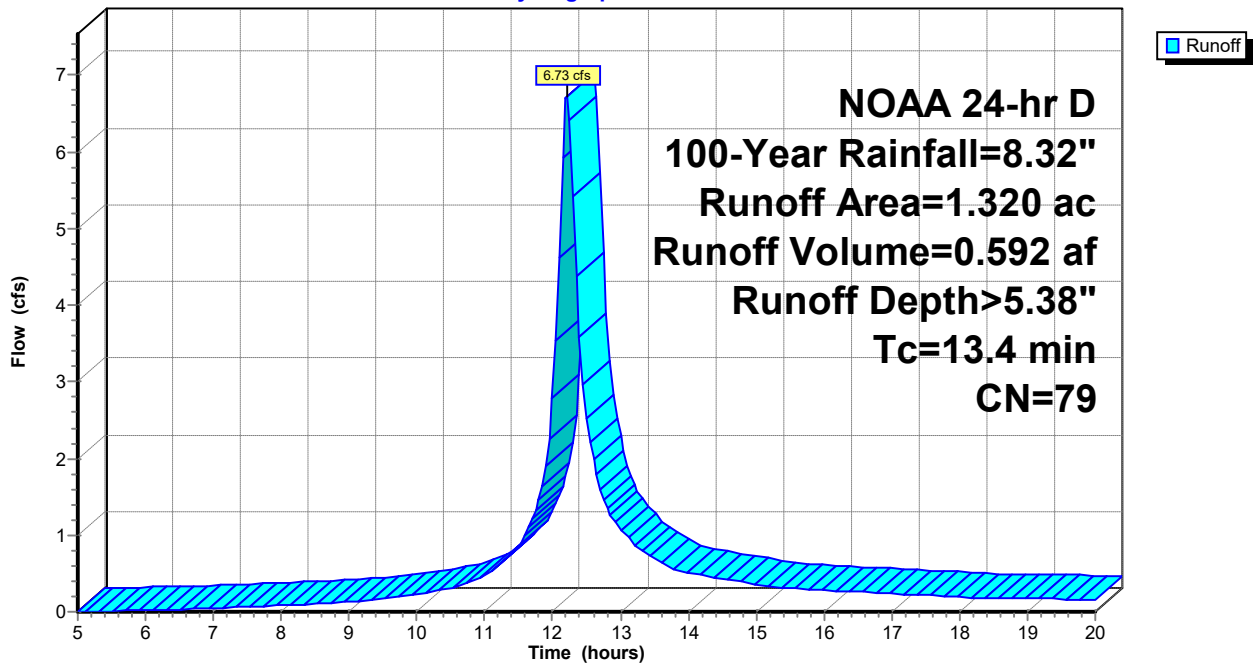

Summary for Pond 14P: UG 120

Inflow Area = 0.990 ac, 0.00% Impervious, Inflow Depth > 6.18" for 100-Year event
 Inflow = 7.01 cfs @ 12.13 hrs, Volume= 0.510 af
 Outflow = 5.40 cfs @ 12.18 hrs, Volume= 0.455 af, Atten= 23%, Lag= 3.4 min
 Discarded = 0.04 cfs @ 6.15 hrs, Volume= 0.046 af
 Primary = 5.37 cfs @ 12.18 hrs, Volume= 0.409 af
 Routed to Pond 19P : PLUNGE POOL 120

Routing by Stor-Ind method, Time Span= 5.00-20.00 hrs, dt= 0.05 hrs
 Peak Elev= 818.73' @ 12.18 hrs Surf.Area= 0.044 ac Storage= 0.144 af

Plug-Flow detention time= 94.3 min calculated for 0.454 af (89% of inflow)
 Center-of-Mass det. time= 57.9 min (815.1 - 757.2)

Volume	Invert	Avail.Storage	Storage Description
#1A	815.00'	0.000 af	24.00'W x 80.00'L x 4.67'H Field A 0.206 af Overall - 0.206 af Embedded = 0.000 af x 40.0% Voids
#2A	815.00'	0.155 af	retain_it retain_it 4.0' x 30 Inside #1 Inside= 84.0"W x 48.0"H => 28.87 sf x 8.00'L = 230.9 cf Outside= 96.0"W x 56.0"H => 37.33 sf x 8.00'L = 298.7 cf 3 Rows adjusted for 196.3 cf perimeter wall
		0.155 af	Total Available Storage

Storage Group A created with Chamber Wizard

Device	Routing	Invert	Outlet Devices
#1	Discarded	815.00'	0.860 in/hr Exfiltration over Surface area
#2	Primary	815.00'	12.0" Round Culvert L= 30.0' CPP, projecting, no headwall, Ke= 0.900 Inlet / Outlet Invert= 815.00' / 814.00' S= 0.0333 '/' Cc= 0.900 n= 0.012, Flow Area= 0.79 sf
#3	Device 2	816.20'	4.0" Vert. Orifice/Grate C= 0.600 Limited to weir flow at low heads
#4	Device 2	818.00'	3.9' long Sharp-Crested Rectangular Weir 2 End Contraction(s)

Discarded OutFlow Max=0.04 cfs @ 6.15 hrs HW=815.05' (Free Discharge)
 ↑**1=Exfiltration** (Exfiltration Controls 0.04 cfs)

Primary OutFlow Max=5.35 cfs @ 12.18 hrs HW=818.71' (Free Discharge)
 ↑**2=Culvert** (Inlet Controls 5.35 cfs @ 6.81 fps)
 ↑**3=Orifice/Grate** (Passes < 0.64 cfs potential flow)
 ↑**4=Sharp-Crested Rectangular Weir** (Passes < 7.36 cfs potential flow)

Pond 14P: UG 120

Hydrograph

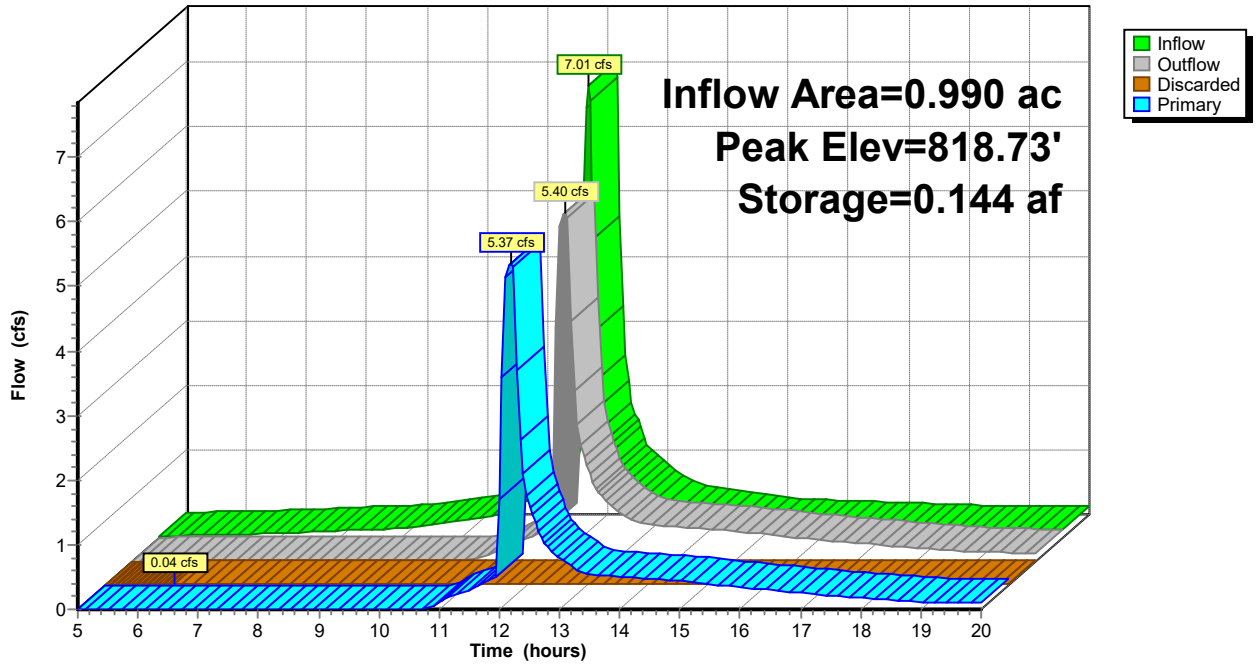

Summary for Pond 16P: DET 210

Inflow Area = 2.220 ac, 0.00% Impervious, Inflow Depth > 6.40" for 100-Year event
 Inflow = 15.78 cfs @ 12.14 hrs, Volume= 1.183 af
 Outflow = 3.70 cfs @ 12.45 hrs, Volume= 1.182 af, Atten= 77%, Lag= 19.0 min
 Discarded = 1.50 cfs @ 12.45 hrs, Volume= 0.957 af
 Primary = 2.20 cfs @ 12.45 hrs, Volume= 0.225 af
 Routed to Link 18L : PR POA / B
 Secondary = 0.00 cfs @ 5.00 hrs, Volume= 0.000 af
 Routed to Link 18L : PR POA / B

Routing by Stor-Ind method, Time Span= 5.00-20.00 hrs, dt= 0.05 hrs
 Peak Elev= 816.89' @ 12.45 hrs Surf.Area= 10,138 sf Storage= 16,672 cf

Plug-Flow detention time= 59.6 min calculated for 1.182 af (100% of inflow)
 Center-of-Mass det. time= 59.0 min (812.7 - 753.7)

Volume	Invert	Avail.Storage	Storage Description		
#1	815.00'	28,806 cf	Custom Stage Data (Conic) Listed below (Recalc)		
Elevation (feet)	Surf.Area (sq-ft)	Inc.Store (cubic-feet)	Cum.Store (cubic-feet)	Wet.Area (sq-ft)	
815.00	7,517	0	0	7,517	
816.00	8,907	8,202	8,202	8,944	
817.00	10,296	9,593	17,795	10,375	
818.00	11,741	11,011	28,806	11,867	

Device	Routing	Invert	Outlet Devices
#1	Discarded	815.00'	6.400 in/hr Exfiltration over Surface area
#2	Primary	815.00'	12.0" Round Culvert L= 127.0' CPP, projecting, no headwall, Ke= 0.900 Inlet / Outlet Invert= 815.00' / 806.40' S= 0.0677 '/' Cc= 0.900 n= 0.012, Flow Area= 0.79 sf
#3	Device 2	815.60'	6.0" Vert. Orifice/Grate C= 0.600 Limited to weir flow at low heads
#4	Device 2	816.80'	14.0' long Sharp-Crested Rectangular Weir 2 End Contraction(s)
#5	Secondary	817.00'	10.0' long + 3.0 ' SideZ x 8.0' breadth Broad-Crested Rectangular Weir Head (feet) 0.20 0.40 0.60 0.80 1.00 1.20 1.40 1.60 1.80 2.00 2.50 3.00 3.50 4.00 4.50 5.00 5.50 Coef. (English) 2.43 2.54 2.70 2.69 2.68 2.68 2.66 2.64 2.64 2.64 2.65 2.65 2.66 2.66 2.68 2.70 2.74

Discarded OutFlow Max=1.50 cfs @ 12.45 hrs HW=816.89' (Free Discharge)
 ↑1=Exfiltration (Exfiltration Controls 1.50 cfs)

Primary OutFlow Max=2.19 cfs @ 12.45 hrs HW=816.89' (Free Discharge)
 ↑2=Culvert (Passes 2.19 cfs of 3.52 cfs potential flow)
 ↑3=Orifice/Grate (Orifice Controls 0.96 cfs @ 4.91 fps)
 ↑4=Sharp-Crested Rectangular Weir (Weir Controls 1.23 cfs @ 0.98 fps)

Secondary OutFlow Max=0.00 cfs @ 5.00 hrs HW=815.00' (Free Discharge)
 ↑5=Broad-Crested Rectangular Weir (Controls 0.00 cfs)

Pond 16P: DET 210

Hydrograph

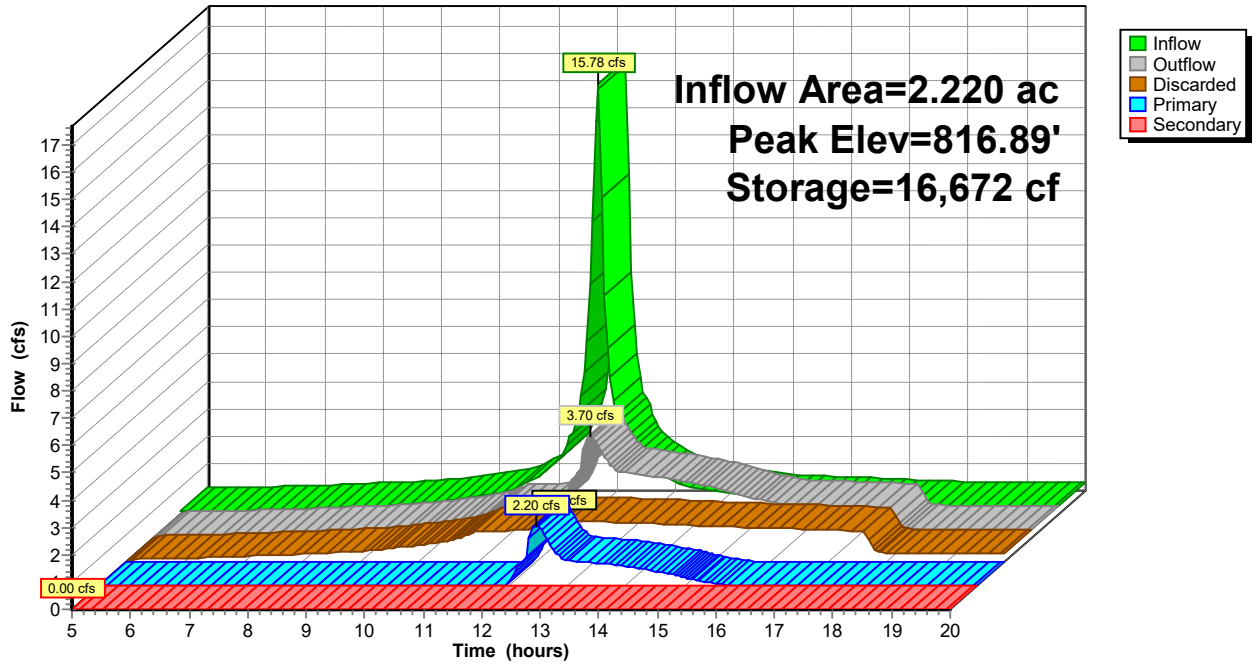

Summary for Pond 17P: DET 220

Inflow Area = 1.110 ac, 0.00% Impervious, Inflow Depth > 6.40" for 100-Year event
 Inflow = 8.03 cfs @ 12.13 hrs, Volume= 0.592 af
 Outflow = 6.71 cfs @ 12.17 hrs, Volume= 0.562 af, Atten= 16%, Lag= 2.5 min
 Discarded = 0.44 cfs @ 12.17 hrs, Volume= 0.305 af
 Primary = 6.27 cfs @ 12.17 hrs, Volume= 0.257 af
 Routed to Link 18L : PR POA / B
 Secondary = 0.00 cfs @ 5.00 hrs, Volume= 0.000 af
 Routed to Link 18L : PR POA / B

Routing by Stor-Ind method, Time Span= 5.00-20.00 hrs, dt= 0.05 hrs
 Peak Elev= 802.93' @ 12.17 hrs Surf.Area= 2,752 sf Storage= 5,100 cf

Plug-Flow detention time= 61.9 min calculated for 0.562 af (95% of inflow)
 Center-of-Mass det. time= 41.8 min (794.9 - 753.1)

Volume	Invert	Avail.Storage	Storage Description		
#1	800.00'	8,875 cf	Custom Stage Data (Conic) Listed below (Recalc)		
Elevation (feet)	Surf.Area (sq-ft)	Inc.Store (cubic-feet)	Cum.Store (cubic-feet)	Wet.Area (sq-ft)	
800.00	879	0	0	879	
801.00	1,441	1,148	1,148	1,454	
802.00	2,039	1,731	2,880	2,070	
803.00	2,810	2,414	5,294	2,860	
804.00	4,412	3,581	8,875	4,476	

Device	Routing	Invert	Outlet Devices
#1	Discarded	800.00'	6.900 in/hr Exfiltration over Surface area
#2	Primary	800.50'	15.0" Round Culvert L= 39.0' CPP, projecting, no headwall, Ke= 0.900 Inlet / Outlet Invert= 800.50' / 800.00' S= 0.0128 '/' Cc= 0.900 n= 0.012, Flow Area= 1.23 sf
#3	Device 2	802.00'	6.0" Vert. Orifice/Grate C= 0.600 Limited to weir flow at low heads
#4	Device 2	802.60'	14.0' long Sharp-Crested Rectangular Weir 2 End Contraction(s)
#5	Secondary	803.00'	10.0' long + 3.0 ' SideZ x 8.0' breadth Broad-Crested Rectangular Weir Head (feet) 0.20 0.40 0.60 0.80 1.00 1.20 1.40 1.60 1.80 2.00 2.50 3.00 3.50 4.00 4.50 5.00 5.50 Coef. (English) 2.43 2.54 2.70 2.69 2.68 2.68 2.66 2.64 2.64 2.64 2.65 2.65 2.66 2.66 2.68 2.70 2.74

Discarded OutFlow Max=0.44 cfs @ 12.17 hrs HW=802.92' (Free Discharge)
 ↑1=Exfiltration (Exfiltration Controls 0.44 cfs)

Primary OutFlow Max=6.25 cfs @ 12.17 hrs HW=802.92' (Free Discharge)
 ↑2=Culvert (Inlet Controls 6.25 cfs @ 5.09 fps)
 ↑3=Orifice/Grate (Passes < 0.77 cfs potential flow)
 ↑4=Sharp-Crested Rectangular Weir (Passes < 8.27 cfs potential flow)

Secondary OutFlow Max=0.00 cfs @ 5.00 hrs HW=800.00' (Free Discharge)
 ↑5=Broad-Crested Rectangular Weir (Controls 0.00 cfs)

Pond 17P: DET 220

Hydrograph

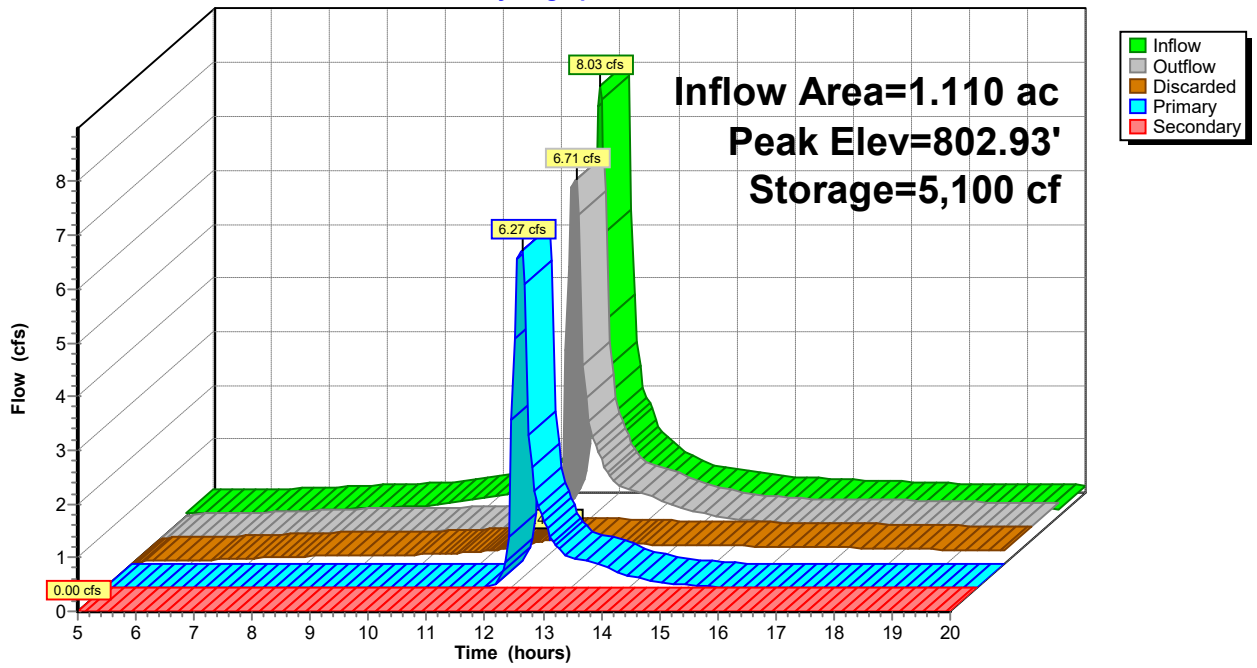

Summary for Pond 19P: PLUNGE POOL 120

Inflow Area = 0.990 ac, 0.00% Impervious, Inflow Depth > 4.96" for 100-Year event
 Inflow = 5.37 cfs @ 12.18 hrs, Volume= 0.409 af
 Outflow = 5.42 cfs @ 12.17 hrs, Volume= 0.398 af, Atten= 0%, Lag= 0.0 min
 Discarded = 0.02 cfs @ 12.17 hrs, Volume= 0.011 af
 Primary = 5.40 cfs @ 12.17 hrs, Volume= 0.387 af
 Routed to Link 15L : PR POA / A

Routing by Stor-Ind method, Time Span= 5.00-20.00 hrs, dt= 0.05 hrs
 Peak Elev= 815.17' @ 12.17 hrs Surf.Area= 845 sf Storage= 622 cf

Plug-Flow detention time= 14.2 min calculated for 0.398 af (97% of inflow)
 Center-of-Mass det. time= 4.6 min (825.5 - 820.9)

Volume	Invert	Avail.Storage	Storage Description
#1	814.00'	1,517 cf	Custom Stage Data (Prismatic) Listed below (Recalc)
Elevation (feet)	Surf.Area (sq-ft)	Inc.Store (cubic-feet)	Cum.Store (cubic-feet)
814.00	223	0	0
815.00	744	484	484
816.00	1,322	1,033	1,517

Device	Routing	Invert	Outlet Devices
#1	Discarded	814.00'	0.860 in/hr Exfiltration over Surface area
#2	Primary	815.00'	30.0' long + 3.0 ' SideZ x 8.0' breadth Broad-Crested Rectangular Weir
Head (feet) 0.20 0.40 0.60 0.80 1.00 1.20 1.40 1.60 1.80			
2.00 2.50 3.00 3.50 4.00 4.50 5.00 5.50			
Coef. (English) 2.43 2.54 2.70 2.69 2.68 2.68 2.66 2.64 2.64			
2.64 2.65 2.65 2.66 2.66 2.68 2.70 2.74			

Discarded OutFlow Max=0.02 cfs @ 12.17 hrs HW=815.17' (Free Discharge)
 ↑1=Exfiltration (Exfiltration Controls 0.02 cfs)

Primary OutFlow Max=5.35 cfs @ 12.17 hrs HW=815.17' (Free Discharge)
 ↑2=Broad-Crested Rectangular Weir (Weir Controls 5.35 cfs @ 1.01 fps)

Pond 19P: PLUNGE POOL 120

Hydrograph

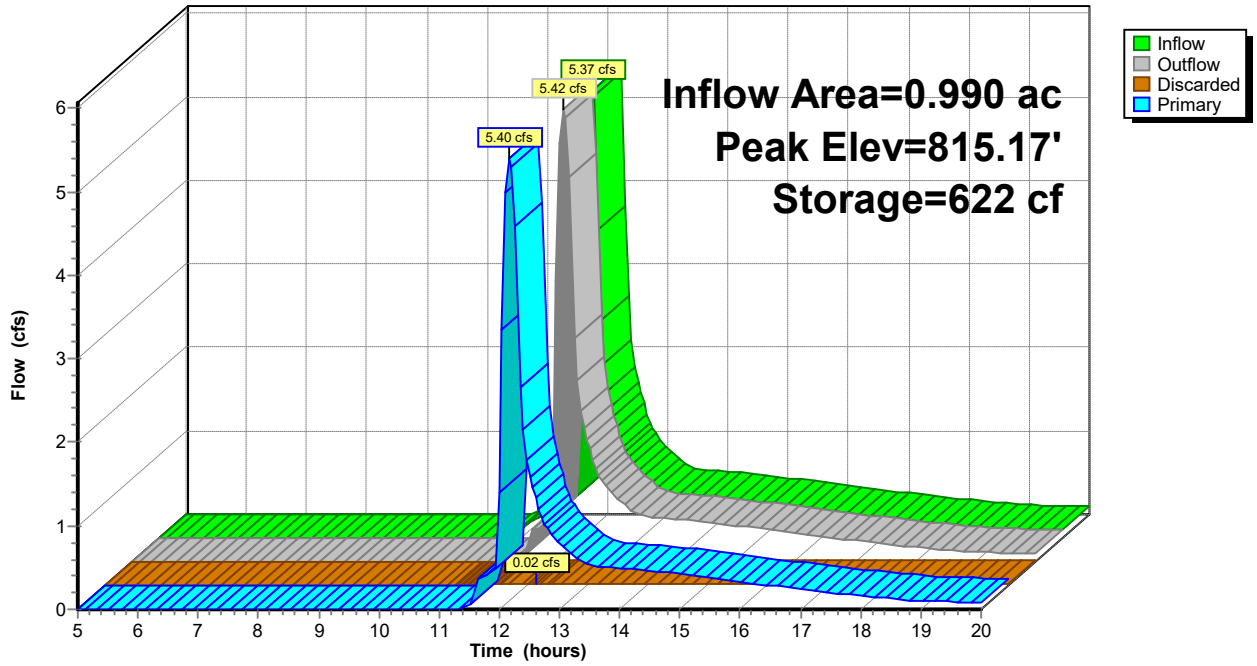

Summary for Link 4L: EX POA / A

Inflow Area = 18.510 ac, 0.00% Impervious, Inflow Depth > 4.59" for 100-Year event
Inflow = 47.11 cfs @ 12.52 hrs, Volume= 7.083 af
Primary = 47.11 cfs @ 12.52 hrs, Volume= 7.083 af, Atten= 0%, Lag= 0.0 min

Primary outflow = Inflow, Time Span= 5.00-20.00 hrs, dt= 0.05 hrs

Link 4L: EX POA / A

Hydrograph

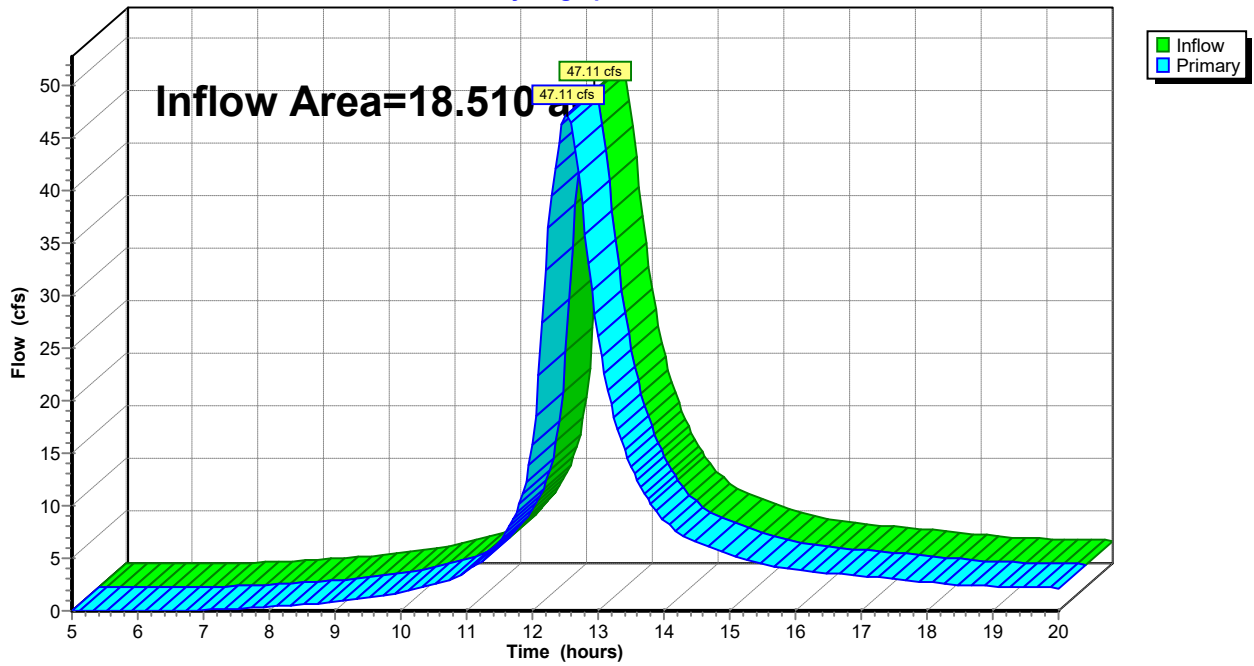

Summary for Link 15L: PR POA / A

Inflow Area = 17.680 ac, 0.00% Impervious, Inflow Depth > 4.70" for 100-Year event
Inflow = 45.43 cfs @ 12.54 hrs, Volume= 6.923 af
Primary = 45.43 cfs @ 12.54 hrs, Volume= 6.923 af, Atten= 0%, Lag= 0.0 min

Primary outflow = Inflow, Time Span= 5.00-20.00 hrs, dt= 0.05 hrs

Link 15L: PR POA / A

Hydrograph

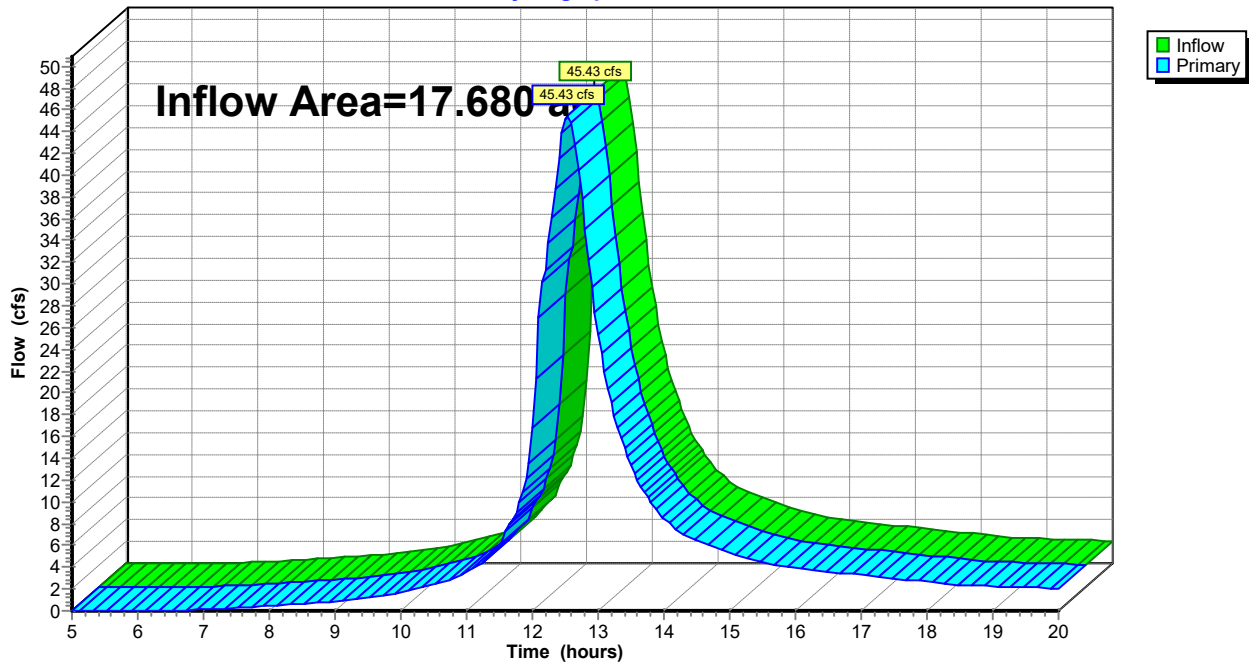

Summary for Link 18L: PR POA / B

Inflow Area = 6.280 ac, 0.00% Impervious, Inflow Depth > 3.61" for 100-Year event
Inflow = 21.62 cfs @ 12.21 hrs, Volume= 1.888 af
Primary = 21.62 cfs @ 12.21 hrs, Volume= 1.888 af, Atten= 0%, Lag= 0.0 min

Primary outflow = Inflow, Time Span= 5.00-20.00 hrs, dt= 0.05 hrs

Link 18L: PR POA / B

Hydrograph

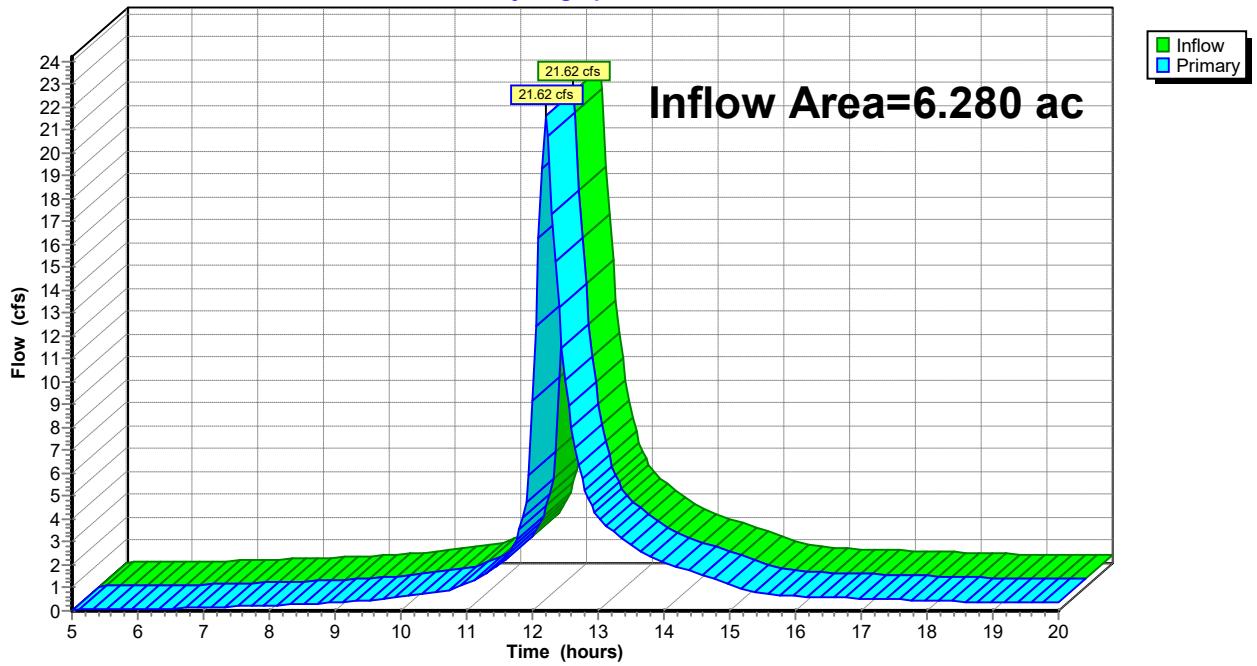

Appendix H

Watershed Maps

Wake Robin Inn Redevelopment

104 & 106 Sharon Road, Salisbury, Connecticut

Drainage Report

Prepared for:
Aradev LLC
352 Atlantic Avenue, Unit 2
Brooklyn, NY 11217

SLR Project No.: 141.22100.00001

July 19, 2024

Revised August 1, 2024



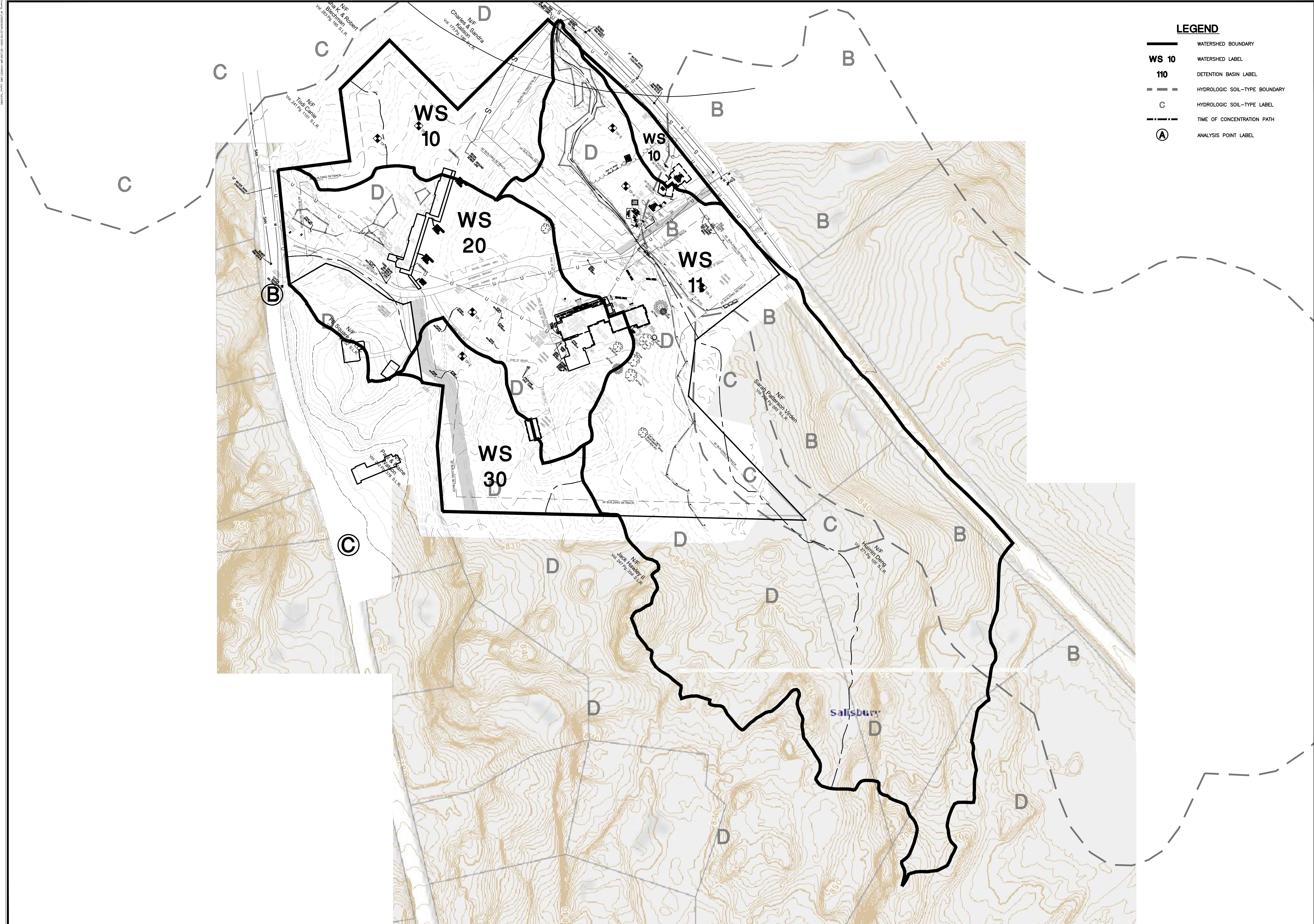

LEGEND

- WATERSHED BOUNDARY
- WS 10** WATERSHED LABEL
- 110** DETENTION BASIN LABEL
- HYDROLOGIC SOIL-TYPE BOUNDARY
- C** HYDROLOGIC SOIL-TYPE LABEL
- TIME OF CONCENTRATION PATH
- ANALYSIS POINT LABEL

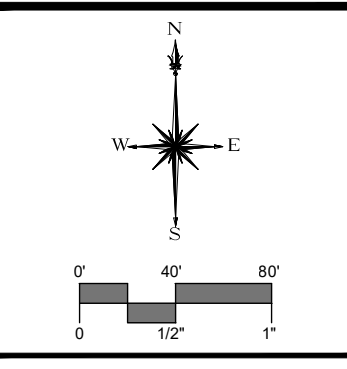

DESCRIPTION	DATE	BY

WATERSHED MAP - EXISTING CONDITIONS
WAKE ROBIN INN REDEVELOPMENT
 104 & 106 SHARON ROAD
 SALISBURY, CONNECTICUT

DESIGNED	MCB	MCB	TDR
DRAWN			
CHECKED			
SCALE: 1"=80'			
DATE: JULY 19, 2024			
PROJECT NO: 22100.00001			
SHEET NO: 1 OF 2			

EXWS

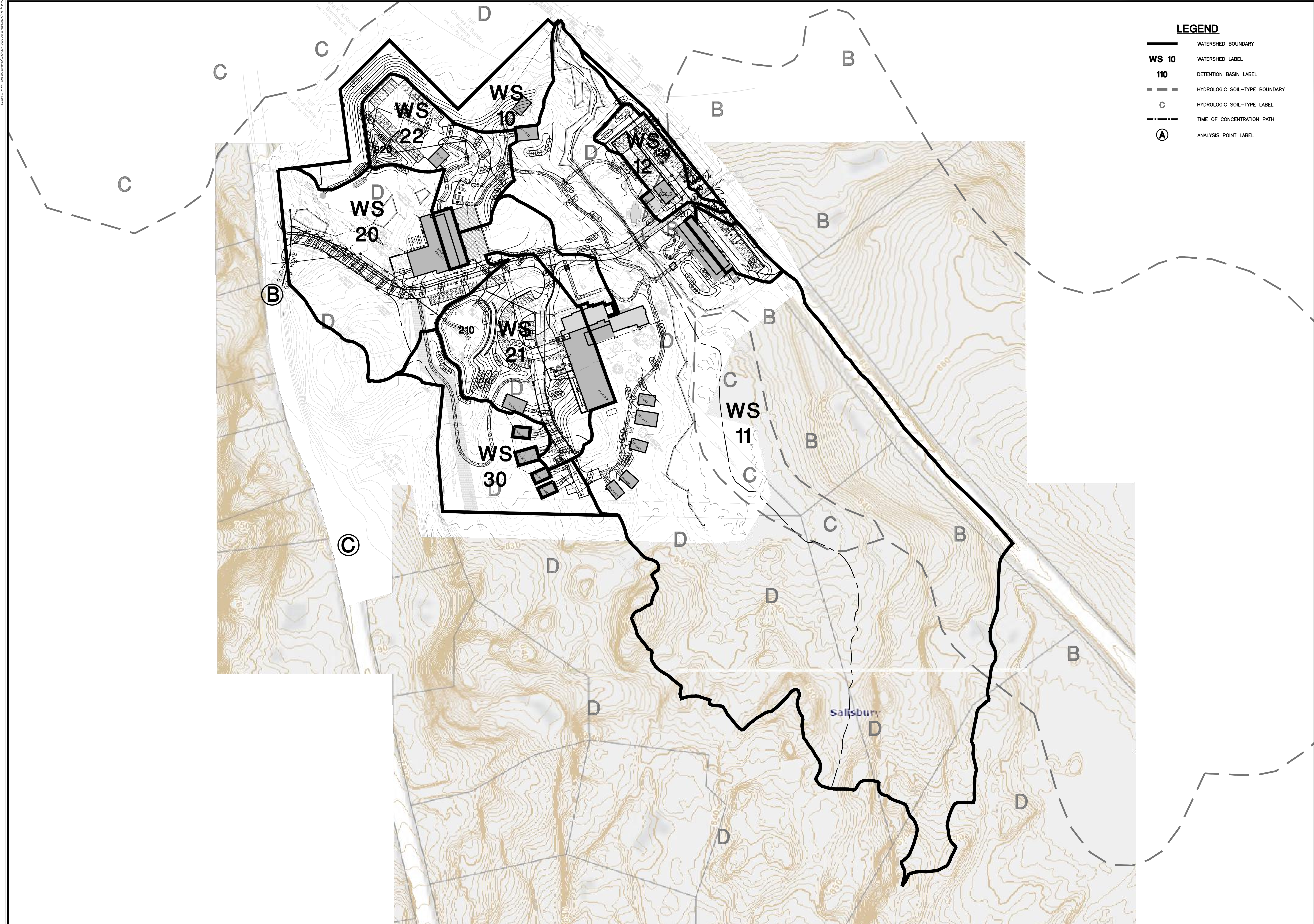

LEGEND

	WATERSHED BOUNDARY
WS 10	WATERSHED LABEL
110	DETENTION BASIN LABEL
	HYDROLOGIC SOIL-TYPE BOUNDARY
C	HYDROLOGIC SOIL-TYPE LABEL
	TIME OF CONCENTRATION PATH
(A)	ANALYSIS POINT LABEL

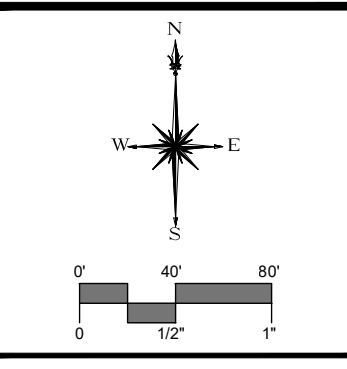

DESCRIPTION	DATE	BY
PAR SUBMISSION	08/01/2024	MCB

WATERSHED MAP - PROPOSED CONDITIONS
WAKE ROBIN INN REDEVELOPMENT
 104 & 106 SHARON ROAD
 SALISBURY, CONNECTICUT

DESIGNED	DRAWN	CHECKED
MCB	MCB	TDR
SCALE: 1"=80'		
DATE: JULY 19, 2024		
PROJECT NO: 22100.00001		
SHEET NO: 2 OF 2		

PRWS